

F
F FUSION
DESIGNS



2024

Solid Wood Furniture, Handmade in the Heartland.



FUSION DESIGNS

EST. 1995

What began as a simple woodworking shop has grown into a trusted source of fine, quality-crafted furniture for every room in the home.

For 2024, we are excited to be able to offer new collections created in the heart of Amish country, most produced and all artfully finished right here in our shop under our strict attention to detail. It's our way of honoring our heritage while pursuing new heights in innovative designs for the future.

We invite you to experience Fusion Designs.

Noah Bontrager

THESE ARE PRINCIPLES
THAT GUIDE US:

QUALITY

Unsurpassed quality standards.

CRAFTSMANSHIP

*A work ethic instilled by
generations of skilled craftsmen.*

INNOVATION

*A dedication to honor the past
and design for the future.*

LIFETIME GUARANTEE

We don't make it complicated. If your properly cared for furniture fails during normal use in the lifetime of the original owner due to problems in either the workmanship or material, we'll repair or replace it for free.

We can do this because we are confident that what we build will last.



FUSION DESIGNS

EST. 1995

CONTENTS

FEATURES, OPTIONS, & CARE	12
Dining	13
Special Table Tops	16
• Plank Tops	
• Live Edge Glue-Up	
Seating	19
Fabrics & Leathers.....	22
Media	23
Hardware Options.....	24
Bedroom	26
Wood Care.....	27
Wood Species & Finishes.....	28
Display Units	30
Internet Policy	31
DINING	32
Dining Collections.....	34
SEATING	102
Chairs	103
Barstools	109
Chair Dimensions	115
Benches.....	119
STORAGE	123
Hutches	124
Additional Storage Options.....	127
Buffets/Sideboards.....	128
LIVING ROOM	134
Living Room Collections	135
• Sofa Tables	
• Coffee Tables	
• End Tables	
ENTERTAINMENT	150
Media Consoles	151
OFFICE	156
Office Collections	158
BEDROOM	168
Bedroom Collections	170

ABOUT US

Fusion Designs is a leader in solid wood case goods made from locally harvested American hardwoods, producing furniture for bedroom, dining room, occasional, entertainment and home office.

Rooted in Amish culture and high-quality construction techniques, Fusion Designs honors its past by individually crafting and hand-finishing its products, while designing for today's lifestyles and aesthetics. Since its founding by Noah Bontrager, the company has built an expansive portfolio of modern and transitional styles, staying ahead of the trend curve by designing both in-house and partnering with world-class furniture designers.

Based in the heartland, Fusion Designs delivers its solid wood, handmade furniture to retailers nationwide, serving some of the largest names in the industry from Top 100 dealers Furniture Row and Living Spaces to smaller independents who look to the family owned and operated company for its customization capabilities and a responsive customer service team that intimately understands their needs.

Led by the second generation and one of the youngest presidents in the industry, Marcus Bontrager heads the in-house design team, inspired by his innate understanding of the needs and desires of a new generation of shoppers. To balance consumers' hunger for personalized looks and innovative features combined with fast shipping, Bontrager eventually shifted to a cellular manufacturing approach that has helped the company shrink lead times and enable quick delivery of bench-built products.

Fueling the company's continued rise is the popular and continually expanding Essentials program. With 65 employees using the same hand-building construction techniques on which the company built its reputation, the Essentials program offers bedroom, dining, entertainment and home office furniture in a choice of 35 finishes, shipped to dealers within 10 business days.

From the start, a focus on innovation has been another key factor in Fusion Designs' growth and success. As the story goes, founder Noah Bontrager got his start in the business making furniture as a hobby while working in the RV industry. Over time, he learned the finer points of construction through trial and error and working alongside generations of talented Amish craftspeople in the region. The fresh perspective he brought to his growing business led to the introduction of a number of industry-leading (and much copied) features, including the butterfly table leaf and ball-bearing slides. In fact, to achieve the superior quality he was after, Bontrager has developed and custom-built proprietary manufacturing equipment for the Fusion Designs 80,000-square-foot manufacturing facility that are unique among case goods manufacturers.

Founded in 1995, Fusion Designs specializes in high-quality, American-made solid wood, built-to-order case goods collections for bedroom, dining room, home office and entertainment sold to leading retailers across the U.S. Handcrafted in Indiana from domestically sourced wood species like oak, maple, cherry and hickory available in a choice of 35 finishes, the expansive portfolio of contemporary, transitional and mid-century modern designs is set apart by mortise and tenon construction techniques, upscale features like soft-close drawers and finishes that highlight the natural beauty of the woods, as well as a lifetime warranty.



For more information, visit fusiondesign.us



THE FUSION DIFFERENCE

At Fusion Designs, we place our emphasis on attention to detail. We strive to bring out the natural beauty and character of each piece of wood. As a result, these one-of-a-kind pieces built with quality workmanship ensure many years of retained beauty and endurance that can be passed on from generation to generation.

Built in the USA

Fusion Designs is putting American people to work! All of our products are handcrafted in our workshop in Goshen, Indiana.

Quality Construction

We take pride in everything we build.

Customizable – Wood & Finish

Choose from 7 kinds of wood and 25 finish options.

Fully Cartoned

Our products are completely cartoned to help prevent damage and delivered to your doorstep.

Quick Lead Time

We work quickly, without sacrificing quality with every order we receive. Therefore, we have a 6-7 week production times for all custom orders.

Quickship Programs

We understand that your showroom or a customer may need products sooner than our standard 6-7 week production time, therefore, we stock our top-selling products and ship in 10 days.

Dealer Protection

We protect our dealers and give them a radius against competitors.

Great Customer Service

Contact us directly anytime during working hours and we will answer any questions you may have.

Lifetime Warranty

You will need to register with us as the original owner of Fusion Design furniture. See page 27 for details.

Responsibility & Sustainability

Fusion Designs works hard to lower our carbon footprint by employing a variety of responsible practices.



THE NATURE OF WOOD AND ITS ENVIRONMENT

Hardwood forests cover more than 269 million acres in the United States. Although it takes about 80 years for a tree to mature, natural reseeded and sprouting contribute to the regeneration of our forests. Conscientious caretakers are also responsible for the ongoing rebirth of this country's hardwood resource thanks to the use of a practice known as sustained yield forest management. Thanks to this practice, the United States grows twice as much hardwood as it harvests every year. In fact, current projections show that by the year 2040, the U.S. will have about 70% more hardwoods available for harvest.

Conservation has long been a byword for the wood industry, both in the forest and in manufacturing. Lumber mills use approximately 98% of the entire tree harvested. Thanks to the introduction of laser-guided saws, improved quality control and computer-assisted manufacturing, virtually nothing is wasted. The bark, which can constitute up to 20% of a log, often fuels the mill. Bark also is used to produce mulches and soil conditioners, while trimmings are processed into a variety of wood products, including paper.

Our trees are an ever-renewing gift from nature. A vibrant hardwood forest is a dynamic force, contributing to a clean, healthy environment. Forests cool the atmosphere and filter the water we drink. They convert carbon dioxide into oxygen to give us air to breathe. They provide food and shelter for wildlife and offer a spectacular variety of recreational opportunities. Each Autumn, their green leaves burst into brilliant symphonies of amber, orange, magenta, and thousands of hues in between.

U.S. hardwoods are coveted all over the world for their warmth and lasting beauty in furniture, cabinetry, mill work, and flooring. In finished products, hardwoods are the purest expression of nature. They are not synthetic, nor are they engineered. Their beauty is not just skin deep.

HARDWOODS

Hardwoods include broad-leaved trees like oak, walnut, cherry, maple, hickory, and dozens of other species. Mature hardwoods supply the nation, and much of the world, with timber used for everything from railroad ties to quality furnishings.

Just as each tree is different from the next, so, too, are hardwood products individually unique. Hardwoods are characterized by an infinite variety of grains and distinctive textures. Trees grow limbs that fall off as the tree matures. What remains is a knot on the hardwood surface. These natural markings add character to the wood's appearance and have absolutely no effect on the wood's durability and stability.

At Fusion Designs, we strive to bring out the natural beauty and character of each piece of wood. These characteristics give each piece its unique charm. As a result, even though the finishing processes are identical, no two pieces will ever be exactly the same. Embrace the uniqueness of your hardwood furniture. It's what nature intended.

REFORESTATION INITIATIVE

We are proud to be partnering with Onetreeplanted.org, a non-profit organization with a focus on restoring the world's forests by planting one tree at a time. We partner by giving a portion of every order towards planting trees all over the world. Through this organization, it takes only \$1 to plant a tree! Go to onetreeplanted.org to learn more.



"When trees mature, it is fair and moral that they are cut for man's use, as they would soon decay and return to the earth. Trees have the yearning to live again, perhaps to provide beauty, strength and utility to serve man and even to become an object of great artistic worth."

George Nakashima
(Master woodworker and renowned leader in 20th century furniture design)

PLACING YOUR ORDER



Easy Steps to Create Your Order

Follow the Steps Below, Copy Your sku Number to the Corresponding Boxes Below. Once Complete, Remove Blank Spaces to Create the sku

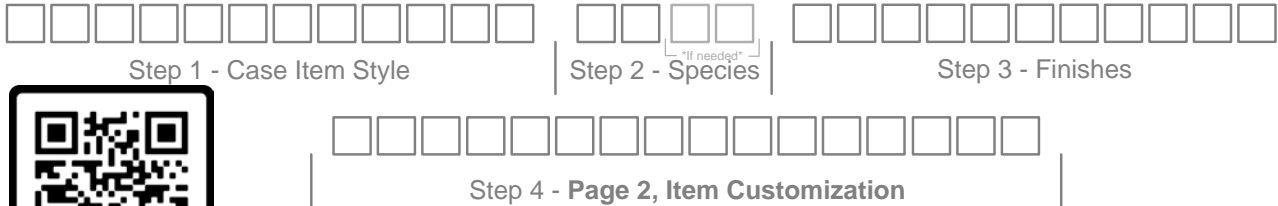

1 Select Style
Enter product Code or Item #



2 Wood Species



- 01 - Quartersawn White Oak
- 02 - Oak
- 03 - Brown Maple
- 04 - Cherry
- 05 - Rustic Cherry
- 06 - Rustic Hickory

3a Finish Colors



- | | | | | | |
|--|---|---|---|--|---|
| <p>Standard</p> <ul style="list-style-type: none"> 30 - Asbury 51 - Autumn 52 - Chilton 65 - Chocolate 116 - Cider | <ul style="list-style-type: none"> 103 - Dew 118 - Flannel 115 - Harbor Gray 68 - Hazelnut 33 - Medium | <ul style="list-style-type: none"> 32 - Michaels 70 - Mocha 53 - Natural 113 - Oatmeal 49 - Onyx | <ul style="list-style-type: none"> 58 - Peanut 100 - Pebble 99 - Toffee 54 - Washington | <p>Premium</p> <ul style="list-style-type: none"> 114 - Aged Mineral 59 - Antique Black 44 - Black 86 - Shale | <ul style="list-style-type: none"> 46 - White 45 - New Century (Distressed) 74 - Rustic Bourbon (Distressed) |
|--|---|---|---|--|---|

3b Add 2nd Color (optional)*

Enter Seat Color Code __ _ followed by "2 T N"

*Base and Top will be Two Different Colors



3c Add Distressed Feature (optional)*

2D - Distressed Finish Option



Case Goods



FUSION DESIGNS

Easy Steps to Create Your Order

Follow the Steps Below, Copy Your sku Number to the Corresponding Boxes Below. Once Complete, Remove Blank Spaces to Create the sku



Seating

1 - Select Seating Style

Use complete chair sku. Sku's that end in "W" signify a wood seat. If your chair has a fabric seat the "W" will be replaced with a "F" or "L" for an upgrade to leather.
 Example "CCSCW" would become CCSCF if ordering a leather seat instead of wood.

2 - Select Bar Chair Base*

*Skip if you are not upgrading to a bar chair base

Upgrade Options
 24B - 24" Stationary Base 24WB - 24" Swivel Base
 30B - 30" Stationary Base 30WB - 30" Swivel Base

3 - Wood Species

01 - Quartersawn White Oak **02 - Oak** **03 - Brown Maple** **04 - Cherry** **05 - Rustic Cherry** **06 - Rustic Hickory**

4a - Finish Colors

Standard	103 - Dew	32 - Michaels	58 - Peanut	Premium	46 - White
30 - Asbury	118 - Flannel	70 - Mocha	100 - Pebble	114 - Aged Mineral	45 - New Century (Distressed)
51 - Autumn	115 - Harbor Gray	53 - Natural	99 - Toffee	59 - Antique Black	44 - Black
52 - Chilton	68 - Hazelnut	113 - Oatmeal	54 - Washington	44 - Black	74 - Rustic Bourbon (Distressed)
65 - Chocolate	33 - Medium	49 - Onyx		86 - Shale	
116 - Cider					

4b - Add 2nd Color (optional)*

Enter Seat Color Code ___ followed by "2 T N" *Chair/Bench Frame and Top will be Two Different Colors

4c - Add Distressed Feature (optional)*

2D - Distressed Finish Option

5 - Select Upholstery Style*

*Skip if you Chose a Wood Seat

Fabric Colors Enter Number for Fabric only in Sku Boxes	Leather Colors BLK - Black BONE - Bone CML - Camel GRAY - Gray	MAH - Mahogany MSRM - Mushroom PCN - Pecan RUM - Rum	GRN - Tapestry TXS - Texas WSKY - Whiskey WBL - Windsor Blue
---	---	---	---

6 - Select Kick-Plate (Bar Chairs Only)

Upgrade Options
 PSC10BK - Black
 PSC10BS - Brushed Stainless Steel

More Options...



...More Customization

Follow the Steps Below to Maximize Your Customization Options. Once Complete, Transfer the sku to the Other Side of This Page. Remove Any Black Spaces (Where Applicable)



7 - More Customization

7a - Select Desk Base Option*

*Only an Option for Arm Chairs

CGL - Caswell Desk Chair Base



7b - Select Nail Head Color*

*Only available on select chairs, see catalog

- F - French Natural
- P - Pewter
- Z - Zink (Standard)



7c - Change to Optional Bench Legs



Seating



FUSION DESIGNS



Easy Steps to Create Your Order

FUSION DESIGNS

Follow the Steps Below, Copy Your sku Number to the Corresponding Boxes Below. Once Complete, Remove Blank Spaces to Create sku



Tables

1 Select Table Style

Enter Product Code or Item # *
 *Use Base Style Code if Opting for the "Build Your Own" Package

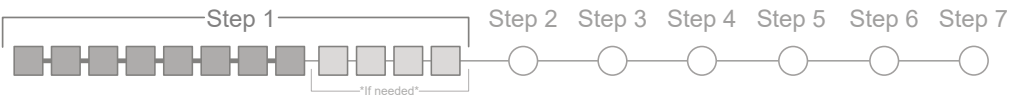

2 Leaf Options

Step 1 Step 2 Step 3 Step 4 Step 5 Step 6 Step 7

Enter Quantity of Leaves Size Optional Upgrade

12 - 12" Wide leaf
16 - 16" Wide leaf

B - Upgrade to butterfly leaf

3 Wood Species

Step 1 Step 2 Step 3 Step 4 Step 5 Step 6 Step 7

01 - Quartersawn White Oak 02 - Oak 03 - Brown Maple 04 - Cherry 05 - Rustic Cherry 06 - Rustic Hickory

Base Species
If Different than Table Top

4a Finish Colors

Step 1 Step 2 Step 3 Step 4 Step 5 Step 6 Step 7

Standard	Premium
30 - Asbury	114 - Aged Mineral
51 - Autumn	59 - Antique Black
52 - Chilton	44 - Black
65 - Chocolate	86 - Shale
116 - Cider	
103 - Dew	46 - White
118 - Flannel	45 - New Century (Distressed)
115 - Harbor Gray	74 - Rustic Bourbon (Distressed)
68 - Hazelnut	
33 - Medium	
32 - Michaels	
70 - Mocha	
53 - Natural	
113 - Oatmeal	
49 - Onyx	
58 - Peanut	
100 - Pebble	
99 - Toffee	
54 - Washington	

4b Add 2nd Color (optional)*

Enter Base Color Code ___ followed by "2 T N" *Table Base and Top Will be Two Different Colors



4c Add Distressed Option (optional)

2D - Distress Finish Option

5 Select Table Shape

Step 1 Step 2 Step 3 Step 4 Step 5 Step 6 Step 7

TM - Mission TSR - Square Round TBS - Boat TT - Tapered TBT - Banquet TR - Round TO - Oval

6 Select Edge Profile

Step 1 Step 2 Step 3 Step 4 Step 5 Step 6 Step 7

EB - Beveled EU - Underbevel EC - Chamfered
 EM - Mission ER - Roundover EO - Ogee

More Options...



...More Customization



FUSION DESIGNS

Follow the Steps Below to Maximize Your Customization Options. Once Complete, Transfer the sku Code to the Other Side of This Page. Remove Any Blank Spaces (Where Applicable)

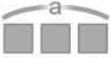

Step 1 Step 2 Step 3 Step 4 Step 5 Step 6 Step 7

7 More Customization

7a Slide Upgrade (Optional)  **BBS** - Ball Bearing Slides

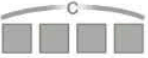
7b Slide Upgrade  **SS** - Self-Store Leaves* 
 *All tables are self-store as a standard. Enter "SS" unless table will not be self-store. Round and square tables cannot be self-store. See our catalog for guidelines regarding self-store options & limitations.
LL - Leaf Locks* 
 *Only Available on Non Self-Storing Leaves

7c Optional Leg Upgrade*  *Skip if Staying with Standard Leg As Shown in Catalog

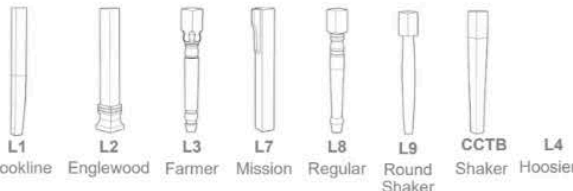

L1 Brookline **L2** Englewood **L3** Farmer **L7** Mission **L8** Regular **L9** Round Shaker **CCTB** Shaker **L4** Hoosier

7d Custom Table Height*  *Skip to Maintain Standard Table Height

TLC - Counter Height
TLC42 - Bar Height

7e Add Inlays  *Skip this This Step if Not Adding or Removing Inlays to Table Top

HI - Add (1) Hayworth Style Inlay to Each End of Top
NI - Remove Inlay 

Important Delivery Info

When shipping, table tops, leaves, and bases are all boxed separately to avoid damage. The table top box will have the complete sku that you have entered. The leaf box also has the same sku but is prefixed by the number (2-). The base will come with the sku prefixed with the number (3-)

- Table Top - (Full sku)
- Table Leaves - (2-Full sku)
- Table Base - (3-Full sku)



FEATURES, OPTIONS & CARE

Customized beauty and the proper care of your furniture will enhance its place in your home and assure that it can endure the test of time. Your furniture can be handed from generation to generation to become a

TIME-HONORED
FAMILY
HEIRLOOM.

DINING FEATURES & OPTIONS

TRESTLE TABLE SELF-STORING FEATURES

42" x 60"
With Skirt: 0
Without Skirt: 4

42" x 66"
With Skirt: 0
Without Skirt: 4



48" x 60"
With Skirt: 2
Without Skirt: 2

48" x 66"
With Skirt: 2
Without Skirt: 2

42" x 72"
With Skirt: 2
Without Skirt: 2

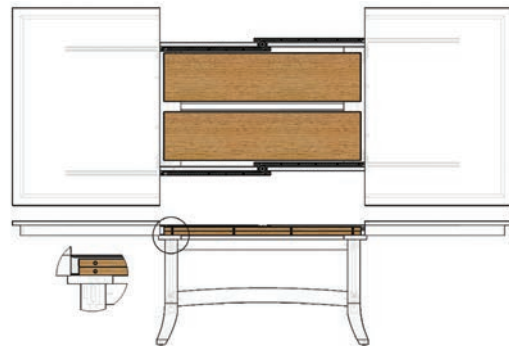
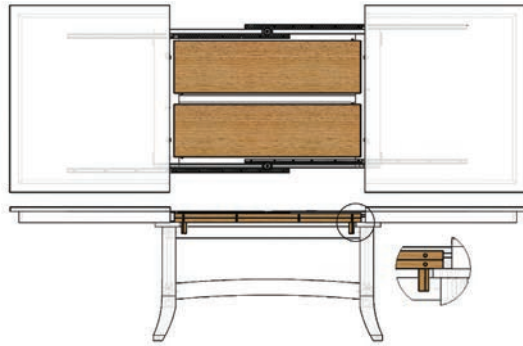

48" x 72"
With Skirt: 0
Without Skirt: 4

TABLE TOP STANDARD FEATURES



12" Table leaves can be stored inside the table to save valuable time and space.



Dining table legs are connected by a reinforced V-grooved corner block with 2 bolts.



1" solid wood table tops are fitted with steam-bent skirts.



Mortise and tenon construction adds strength to each piece.



Each dining table is number-branded and signed by the craftsman who created your individual piece.



Each dining table's unique leaves receive that table's serial number and numerical label for installation.

PREMIUM SLIDE SYSTEM UPGRADE

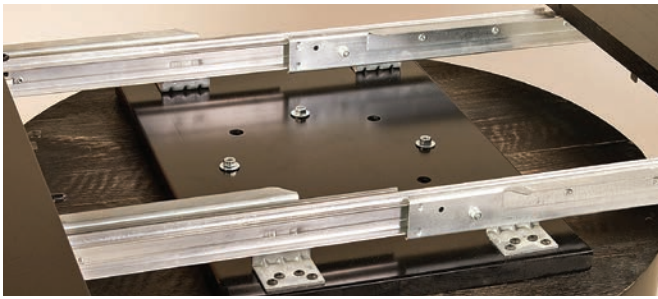

These slides are second to none and well worth the upgrade! Slides will not warp or bind over time and will work as good in 40 years as the day they were installed. *BBS slides are not available on round tables with butterfly style leaves.

INLAY OPTION



Hayworth Inlay can be added to any top. Option includes 1 inlay at each end of table (2 inlays).

CENTER LEG GUIDELINES FOR WOOD SLIDES

36" & 42" Wide Rules: When adding 32" - 84" in leaves, table receives 1 center leg. When adding 84" - 120" in leaves, table receives 2 doubles (4 legs). When adding 120"+, table receives 1 double and 2 singles (4 legs).

48" Wide Rules: 32" - 48" in leaves, table receives 1 center leg. When adding 48" - 84" in leaves, table receives 1 double (2 legs). When adding 84" - 120" in leaves, table receives 2 doubles (4 legs). When adding 120"+, table receives 1 double and 2 singles (4 legs).

Solid Top Rules: 84" and longer receive 1 center leg.

CENTER LEG GUIDELINES FOR BBS SLIDES

36" & 42" Wide Rules: When adding 32" - 84" in leaves, table receives 1 center leg. When adding 84" - 120" in leaves, table receives 2 doubles (4 legs). When adding 120"+, table receives 1 double and 2 singles (4 legs).

48" Wide Rules: 17" - 48" in leaves, table receives 1 center leg. When adding 48" - 84" in leaves, table receives 1 double (2 legs). When adding 84" - 120" in leaves, table receives 2 doubles (4 legs). When adding 120"+, table receives 1 double and 2 singles (4 legs).

Solid Top Rules: 84" and longer receive 1 center leg.

BUTTERFLY LEAF DETAILS



Butterfly leaf round tables cannot be built using aprons on leaves or have BBS slides. Round tops with butterfly leaves are also not available any smaller than 42" in diameter. Butterfly leaf tables are not available in custom sizes. *Butterfly leaves are not available on any thickness other than 1.

SELF STORING SPECIFICATIONS

All tables will be built to self-store and leaf skirt will be added accordingly. If tables cannot self-store (all round or square tables), skirt will be added to leaves as a standard feature. Leaf skirt can be requested for all leaves but must be specified at time of order placement and may void self-storing, see the following rules:

- Self-store is not available on round or square table tops unless using 1" butterfly leaves.
- 1 3/8" thick tops can only self-store 1 leaf without skirt.
- Trestle tables and double pedestal tables with 1" thick top can store as follows: 36" wide will store 2-12" leaves, 42" wide will store 4-12" leaves, 2 with skirt and 2 without; 48" wide will store 4-12" leaves, all without skirt. Any double pedestal or trestle tables that is less than 72" long will only store 2 without skirt. Boat or Oval tops can only self store 2 leaves, 1 with skirt and 1 without.
- Leg tables with 1" thick top can store as follows: 36" wide will store 2-12" leaves without skirt, 16" leaves cannot self-store with 36" wide table; 42" wide will store 4-12" leaves, 2 with skirt and 2 without or 2-16" leaves, 1 with skirt and 1 without; 48" wide will store 4-12" leaves, 2 with skirt and 2 without or 2-16" leaves, 1 with skirt and 1 without; Boat or Oval tops can only self-store 2 leaves, 1 with skirt and 1 without; 42"x60" and 42"x66" leg tables with BBS slides can only self-store 2-12" leaves, 1 with skirt and 1 without or 2-16" leaves 1 with skirt and 1 without.



Leaf and table locks can be added to tables and leaves in order to hold table together however tables will no longer be able to self-store leaves.

DINING FEATURES & OPTIONS

MAGNETIC LEAF LOCKS

STANDARD WITH ALL BALL BEARING TABLE SLIDES

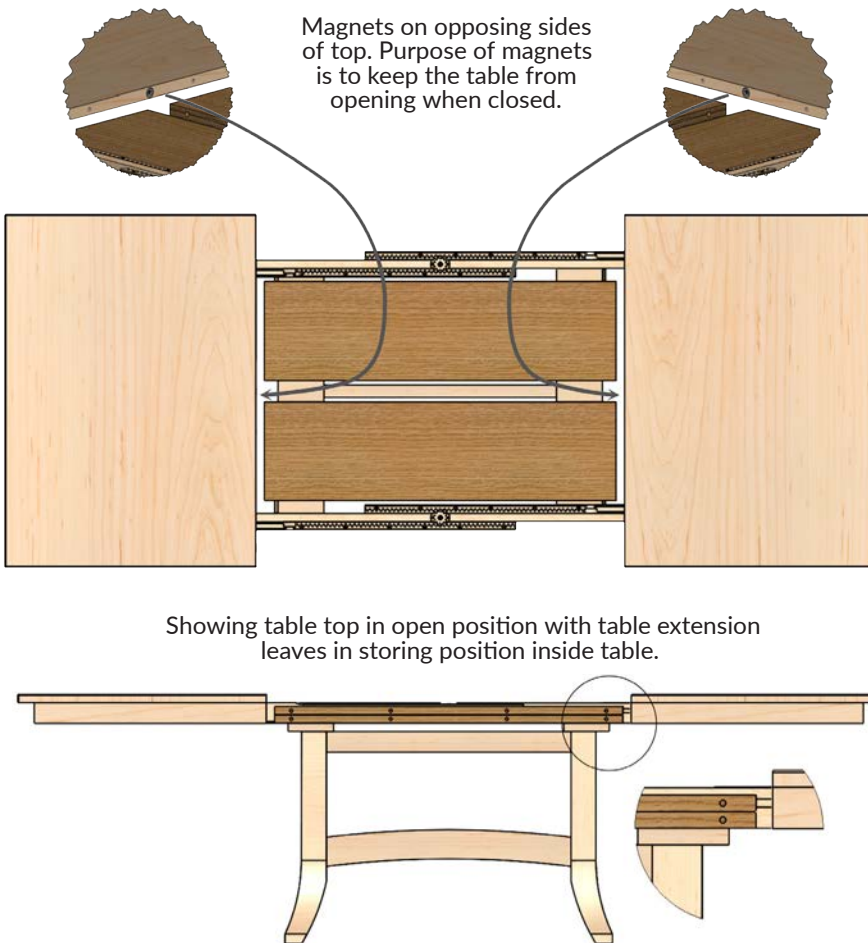

Don't settle for the hassle and inconvenience of traditional leaf locks

MAGNETIC LEAF LOCK BENEFITS:

- Seamlessly extend or retract your table leaves without any fuss.
- Built right into the edge of your table leaves, holding them securely in place during use.
- No more wobbling or shifting, just a stable and sturdy surface for you and your guests to enjoy.
- When it's time to store your leaves, simply retract them back into the table and store them until needed.
- Does not interfere with our self-storing feature.

scan for more information



DINING FEATURES & OPTIONS

EDGE PROFILES

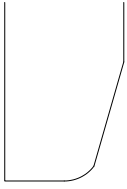

Bevel #EB

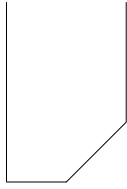

Chamfer #EC



Mission #EM

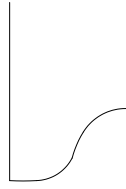

Ogee #EO

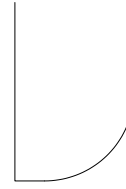

Roundover #ER

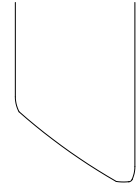

Underbevel #EU

TABLE TOP SHAPES

Dining table tops are available in the sizes listed below. See bases for amount of leaves each size will accommodate.

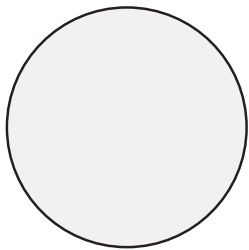

Round #TR

36" x 36"
42" x 42"
48" x 48"
54" x 54"
60" x 60"
72" x 72"

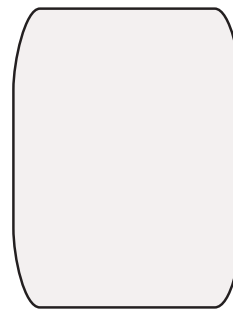

Boat Shape #TBS

36" x 36"	42" x 66"	48" x 72"
36" x 48"	42" x 72"	48" x 84"
36" x 54"	42" x 84"	48" x 96"
36" x 60"	42" x 96"	54" x 54"
42" x 42"	48" x 48"	60" x 60"
42" x 54"	48" x 60"	72" x 72"
42" x 60"	48" x 66"	

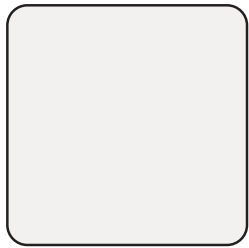

Square-Round #TSR

36" x 36"	42" x 66"	48" x 72"
36" x 48"	42" x 72"	48" x 84"
36" x 54"	42" x 84"	48" x 96"
36" x 60"	42" x 96"	54" x 54"
42" x 42"	48" x 48"	60" x 60"
42" x 54"	48" x 60"	72" x 72"
42" x 60"	48" x 66"	

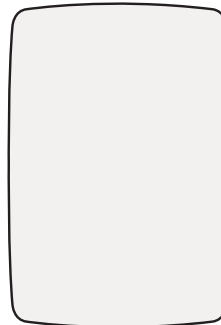

Banquet #TBT

36" x 36"	42" x 66"	48" x 72"
36" x 48"	42" x 72"	48" x 84"
36" x 54"	42" x 84"	48" x 96"
36" x 60"	42" x 96"	54" x 54"
42" x 42"	48" x 48"	60" x 60"
42" x 54"	48" x 60"	72" x 72"
42" x 60"	48" x 66"	

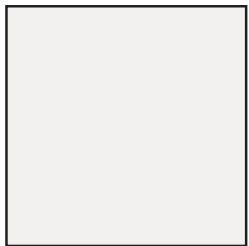

Mission #TM

36" x 36"	42" x 66"	48" x 72"
36" x 48"	42" x 72"	48" x 84"
36" x 54"	42" x 84"	48" x 96"
36" x 60"	42" x 96"	54" x 54"
42" x 42"	48" x 48"	60" x 60"
42" x 54"	48" x 60"	72" x 72"
42" x 60"	48" x 66"	

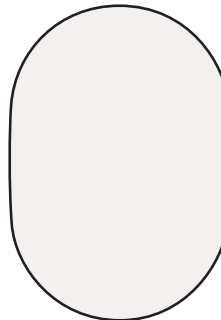

Oval #TR

36" x 48"	42" x 84"
36" x 54"	42" x 96"
36" x 60"	48" x 60"
42" x 54"	48" x 66"
42" x 60"	48" x 72"
42" x 66"	48" x 84"
42" x 72"	48" x 96"

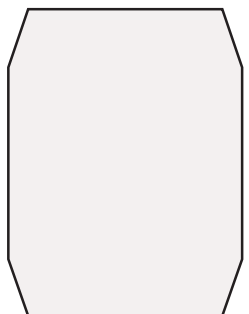

Tapered #TT

36" x 36"	42" x 66"	48" x 72"
36" x 48"	42" x 72"	48" x 84"
36" x 54"	42" x 84"	48" x 96"
36" x 60"	42" x 96"	54" x 54"
42" x 42"	48" x 48"	60" x 60"
42" x 54"	48" x 60"	72" x 72"
42" x 60"	48" x 66"	

TABLE BASE OPTIONS

LEGS

Maximum extended size with leaves installed for leg bases is 216" in length. Any leg table over 2 leaves will have a center leg added for support. Round or oval tops will be built with square skirt.



SINGLE PEDESTALS Maximum extended size with leaves installed for these bases is 66" in length.



Maximum extended size with leaves installed for these bases is 72" in length.

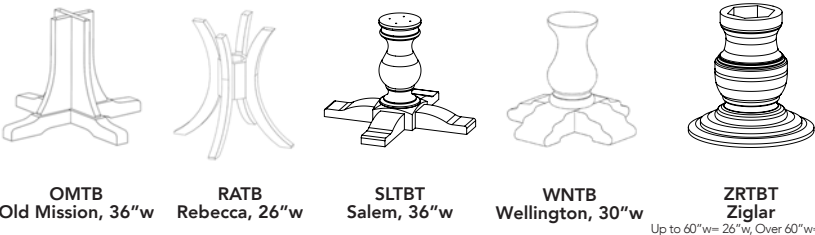
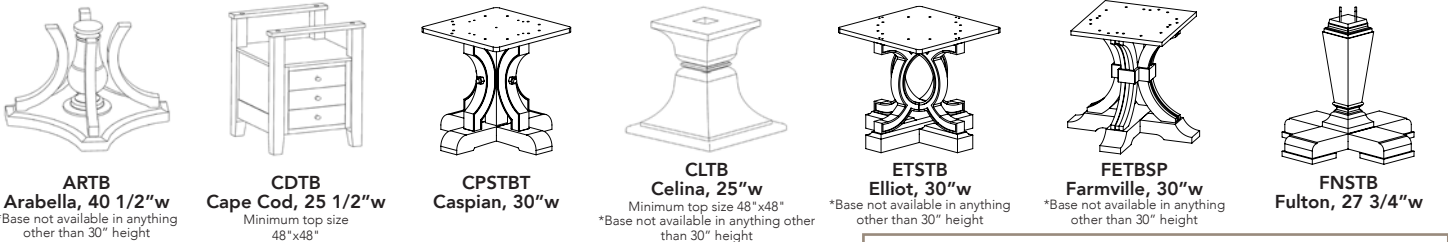

Maximum extended size with leaves installed for these bases is 192" in length.

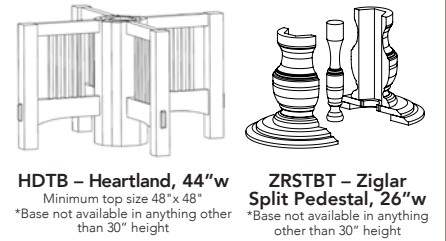

DOUBLE PEDESTALS Maximum extended size with leaves installed for this base is 120" in length.

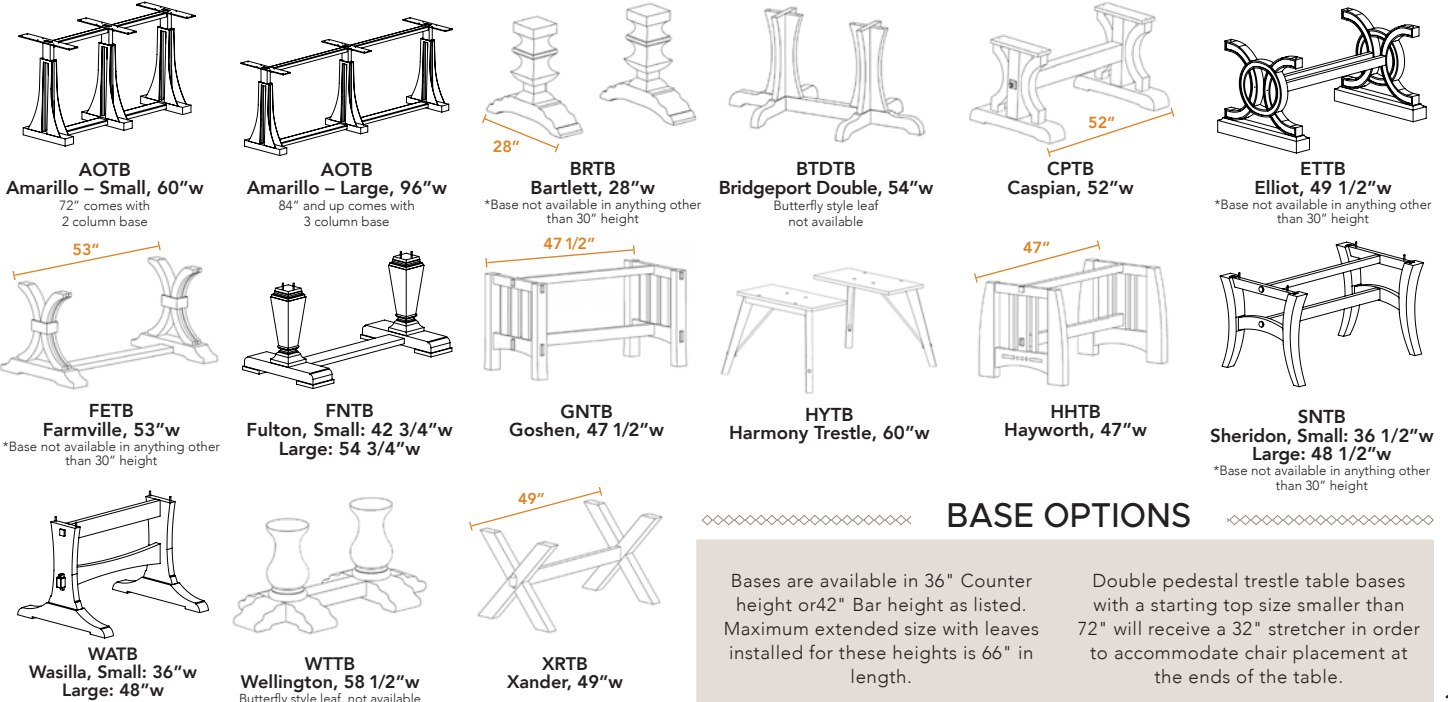

BASE OPTIONS

Bases are available in 36" Counter height or 42" Bar height as listed. Maximum extended size with leaves installed for these heights is 66" in length.

Double pedestal trestle table bases with a starting top size smaller than 72" will receive a 32" stretcher in order to accommodate chair placement at the ends of the table.

CHARACTERISTICS OF SPECIAL TABLE TOPS

Plank Top

A plank-style top is created by randomly joining boards with bread-boarded ends and in varying widths from 2 to 13 inches. Depth of offset from board to board as much as $\frac{3}{8}$ " as well as the number of visible saw cuts will also vary from top to top. Due to the individual uniqueness of each plank top, widths, depth of offsets and saw mark patterns or locations cannot be specified when ordering.

Humidity will affect these types of tops more than a standard top with no breadboards. The breadboards and the boards on the table are moving opposite ways since the grain direction is not the same. This causes shifting of up to $\frac{3}{4}$ ", gapping and the tongue and groove area to sometimes be exposed. Correcting the humidity level in the room will help minimize shifting and gapping, but none of the inconsistencies found in plank-style tops or any top with bread-boarded ends are considered defects. They should, instead, be embraced as unique characteristics of each piece of furniture handcrafted in this manner.

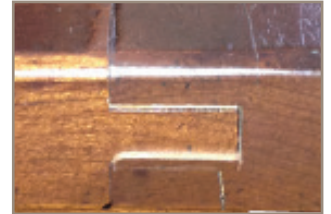

Showing an **exposed groove** in breadboard



Showing an **exposed board** at breadboard joint



Example of edge with greater angle



Example of edge with little angle

Live-Edge Glue-Up Top

Live-edge glue-up tops are $1\frac{3}{8}$ " thick with live edge pieces on each side and random staves glued in between to achieve the required width. Width is still approximate because of the variation of shapes of the edges. Width can vary by as much as 14" due to the random shapes of the trees from which these pieces are cut. The angle of the edge is determined by where within the log the board was extracted. A table edge without an angle would have been cut from the center of the log. If it has a sharper angle, it means the board was taken close to the outside of the log. One advantage that a glue-up top has compared to a bookmatch live edge slab is that glue-ups tend to be more stable resulting in less cracking and movement as well as lesser cost because of the thickness.

Example of shape without a lot of variation



SEATING FEATURES & OPTIONS

CHAIRS

CHAIR FEATURES

- Constructed with solid hardwoods
- Glued mortise and tenon joints
- Accurately leveled for stability
- Fabric and leather seats are hand selected for consistency

CHAIR OPTIONS

- Distressed finish (#2D)
- Two-tone finish (#2TN)
- Fabric and leather seats available
- Bar stools are available in 24" or 30" high
- Caswell gas desk chair base (#CGL)



Joined using both **screws and glue**



Corner block strengthens corners



Caswell Gas Lift Base #CGL

- When ordering, add desk chair base style # to end of arm chair # for correct item code
- Only available on arm chairs



Solid wood chair backs and table aprons are steam bent during a process that takes days to complete. Once bent, these solid wood parts will last for many lifetimes.



Protective Stretcher Cover (#PC)

- Protective cover available in Black and Brushed Stainless. Covers are available on bar chairs only.



SEATING FEATURES & OPTIONS

CHAIR CONSTRUCTION

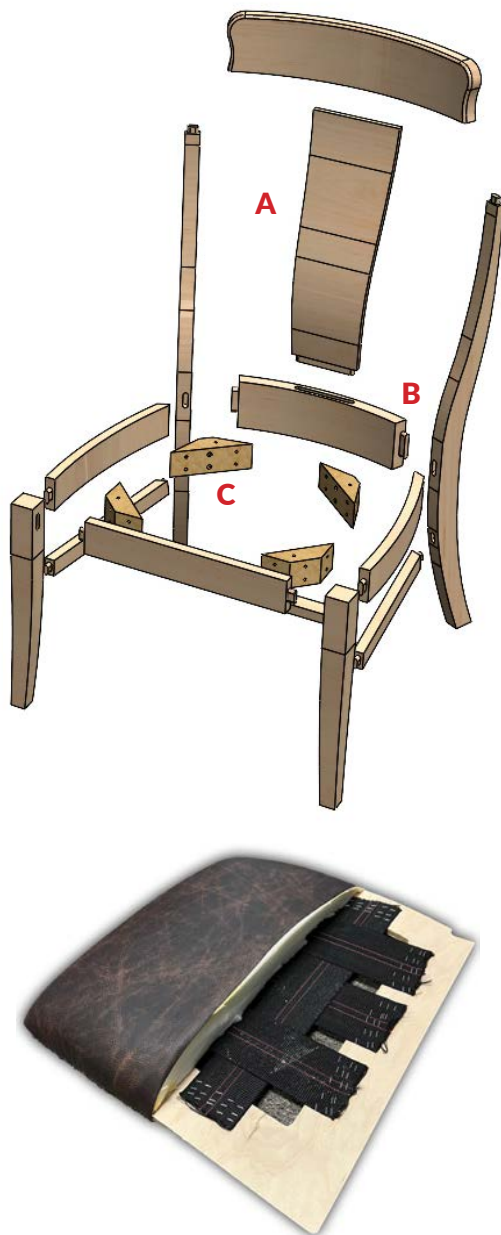

Steam Bent Support (A)

We use high-pressure steam to bend wood into a shape that looks beautiful and provides unparalleled comfort and support.

Mortise & Tenon Joints (B)

A technique that creates a strong and durable frame to withstand everyday use. It also creates a tight and secure fit, making the sturdier and longer-lasting.

Corner Bracing (C)

A framing technique that uses corner blocks to provide additional strength and stability.

Scooped Wood Seats

Designed to contour to the shape of your body, our molded wood seats provide maximum comfort while also helping to maintain proper posture.

Sustainably Sourced Solid Wood

All our chairs are made using responsibly sourced solid wood, giving you the peace of mind that you are making a responsible and sustainable choice.

Superior Comfort with Upholstery

Unlike our competitors, our upholstered seats are built with high quality webbing with a cutout frame that conforms to your body and provides optimal support.

We exclusively use the highest-quality upholstery: stain-resistant, easy to clean performance fabrics as well as durable, long-lasting premium leathers.

scan for more information



UPHOSTERED LIVING ROOM FURNITURE CONSTRUCTION



Unrivaled Seating Support:

Features a #8 Heavy Duty Zig-Zag style spring system for seating to ensure consistent support and resilience for years to come.



Craftsmanship Beyond Compare:

We've covered the springs with a 1.25oz dust cover and a 3/8" thick insulpad to ensure that your furniture not only looks great but is built to withstand the test of time.



Luxurious Comfort:

The sides of our furniture are covered with Dacron and polyester batting. Sink into the plushness and experience the difference this extra layer of comfort makes.



Fully Upholstered Backs:

We fully upholster the backs of our chairs, sofas, and loveseats to ensure that your furniture looks stunning from every angle.



Premium Materials:

We take pride in offering only the finest materials for our furniture. From performance fabrics to premium leathers, every piece exudes sophistication and luxury.



Unbeatable Cushions:

Our seat cushions boast a 2.8 density with a compression of 35, ensuring a comfortable yet supportive seating experience. Back cushions feature open cell foam with polyester batting, creating a perfect balance of softness and resilience.



Elegance in Style:

Our pillowy box-style seats not only contribute to the exceptional comfort but also make a bold style statement. Fusion Designs' furniture is the epitome of tasteful elegance, making your living room truly stand out.

scan for more information



FABRICS & LEATHERS

FABRICS

One Less Thing to Worry About!

Performance Fabrics are engineered for easy maintenance, comfort, and durability. Performance Fabrics are soft, durable, and stain-resistant. These fabrics are available in a wide array of textures and vibrant colors. Breakthrough protection is woven into every fiber so it won't ever wear away.

Easy Clean:

Performance Fabrics are easy to clean, but are not self-cleaning. Most liquid spills will simply blot off the surface with a dry towel. And for more difficult stains, just follow these simple spot-cleaning instructions:

- Wipe away excess mess using a clean, dry towel
- Mix a simple soap and water solution*
- Apply and agitate with a soft-bristle brush
- Blot with a clean towel
- Rinse thoroughly, repeat if necessary

*We recommend mixing 1 tsp. enzyme laundry detergent, like Tide® or Cheer®, with 2 cups warm water. And remember, soap attracts dirt, so rinse thoroughly.



LEATHERS

Descriptions:

- Premium top-grain glove-soft leather, offers exceptionally soft, silky, hand feel
- Soft silk hand enhanced with the application of a wax touch agent.
- A slightly contrasting crust color is randomly top-sprayed with a translucent solution of highly dispersed micro-pigments to give this leather gentle clouding or smoke effect.
- The natural glow and depth created enhances the sophisticated appearance of this leather.

Thickness:

- 0.9 – 1.0 mm thick

Natural Visibility:

- Some natural marking visible

Finish:

- Top-grain, aniline drum-dyed, micro-pigmented topcoat.
- Moderate protection from application of micro-pigmented topcoat.
- The beauty of aniline drum-dyed leather is the lack of uniformity. The dye does not color all sections of the hide uniformly due to the tissue (or cell) structure.
- The neck may be a bit lighter or darker than the butt; the rib and fat wrinkles may be outlined in a slightly darker cast.

Care & Cleaning:

Vacuum or dust with a soft brush regularly.

For Spots and Spills:

- Gently blot excess liquid with a clean absorbent cloth
- Let air dry naturally

For Butter, Oil, or Grease:

- Absorb excess with a clean, dry cloth
- Leave alone
- Spots should dissipate over a moderate time

Do not apply any shoe polish, ammonia water, oils, or any other chemical solutions.

Recommended: Car and Cleaning kits such as those provided by Leather Master. The natural oils are sealed in for permanent and carefree beauty.



Any fabrics or leathers not in the current book will be treated as COM and must be sent to Fusion.

MEDIA FEATURES & OPTIONS

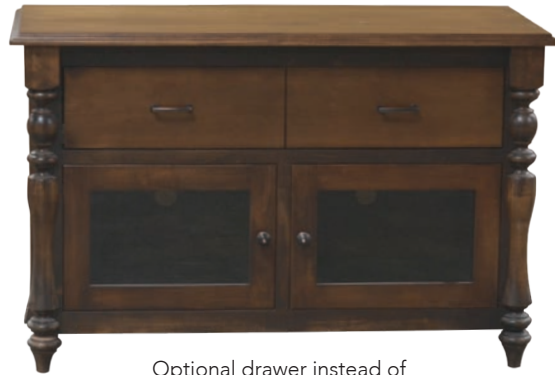

Optional drawer instead of sound bar opening (#OD)



Optional flip-down glass or wood drawer front for sound bar opening (#OGD)



Removable backs provide easy access for installation of new components



Vented shelves and floors protect your media

Solid wood is used throughout our construction process including case goods and beds however there are times when the design or construction of the item requires us to use some MDF core plywood in order to prevent shrinking or expanding that could be detrimental to the integrity of the piece. There are many different types of plywood cores including veneer core, MDF core and Partical board however all of these are considered plywood which means a veneered piece of wood over a substrate. The reason MDF core is used in a lot of the furniture industry including kitchen cabinets is that it is considered the premier "plywood" to use due to it having a more consistent flat surface. Veneer core can have a "rippling" effect because it is softer in some spots than others making a smooth surface difficult to achieve. Also veneer core plywood will still have a tiny bit of movement where MDF core will not.



Easy gaming and accessory storage

HARDWARE

Pictures are not accurate assessment of size. See measurements for actual size.



A-1 Satin Nickel 5 1/2"



A-2
Oil Rubbed
Bronze



A-3
Windover
Antique



B-2 Satin Nickel 1 3/4"

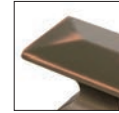

B-3
Oil Rubbed
Bronze

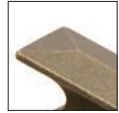

B-4
Windover
Antique



BH-1
Beacon Hill Handle
Black Iron, 12" Wide



BH-2
Beacon Hill Knob
Black Iron, 1 1/2"



C-3 Antique English 3 3/4"



C-4
Black Iron



D-4 Antique English 1 1/4"



D-5
Black Iron



E-5 Oil Rubbed Bronze 1 1/4"



E-6
Antique
English



E-7
Dark Brushed
Copper
Machined



E-8
Dark Brushed
Antique
Copper



E-9
Satin Nickel



Satin Nickel
F-6 5 1/2" wide
F-7 15" wide



G-7 Satin Nickel 1 1/2"



H-8 Black 3 3/4" x 2"



H-9
Antique English



I-9 Available in
Black or Finished 1 1/4"



J-10 Black Iron 1 1/4"



K-11 Satin Nickel 3 3/4"



K-12
Veneti Bronze



M-1 Gold 1 1/8"



M-2 Gold 5 3/4"



M-13 Black 1" x 3 3/4"



M-14
Antique English



N-14 Available in Black or Finished 1 1/2"



O-15 Satin Nickel 2"



O-16
Black Bronze



P-16 Bright Nickel
Brushed Dull 3 3/4"



Q-17 Bright Nickel
Brushed Dull 1 1/4"



R-18 Satin Nickel 4 1/2"
R-2 Satin Nickel 6"



S-19 Antique English 3 1/2" x 1 1/2"



SO-1 Soma Knob
Antique Brass, 3 1/4"



Y-2 Oil Rubbed Bronze Dull 4"



U-1 Oil Rubbed Bronze 1 1/4"



U-3
Satin Nickel



U-2 Oil Rubbed Bronze 3 3/4"



W-1 Black 1 1/4" x 4 1/2"



W-3
Oil Rubbed Bronze



W-4
Antique Copper



W-6
Oil Rubbed Bronze



W-7
Antique Copper



W-2 Black 1 1/4" x 4 1/2"



X-1
Oil Rubbed Bronze
Highlighted

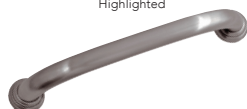

X-2 Satin Nickel, 5 1/8"



Y-1 Oil Rubbed Bronze Dull



Z-4 Satin Nickel, 1 1/4"



Z-3
Brushed Oil
Rubbed Bronze



Z-5
Pewter



Z-6
Antique English

BEDROOM FEATURES & OPTIONS



Optional **footrail** instead of footboard is available on most beds.



Optional **underbed storage drawers**. Multiple storage rail configurations are available. See line drawings for details.

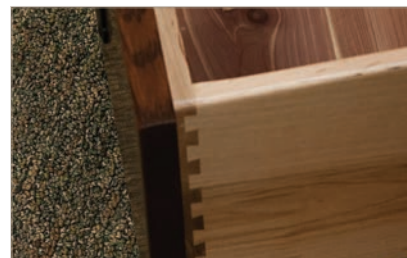

Dovetail joinery is a time-honored technique that connects each board with interlocking pins and tails.



Optional **LED night light** with touch switch (#LEDN)



Optional **sliding top nightstand** with secret compartment, lock and 3-plug power strip (#STP)



Optional **peg** for hanging clothes (#POR)



Cast metal brackets firmly hold bed slats in place providing solid support for every mattress size.



Most drawers are available with **cedar lining**.



Dressers and chests can be customized with **drawer dividers** and optional **felt-lined jewelry tray**.



Fusion Designs uses **floating panel construction**. Rubber space balls are inserted into the frame so the wood panels can expand and contract without causing damage. **Soft-close undermount drawer glides** assure quiet operation of solid wood drawers.



2 plug, 2 USB **power port** available in all nightstand top drawers (#DKD). Removable tray keeps drawer organized and can be used as a portable work surface.

Solid wood is used throughout our construction process including case goods and beds however there are times when the design or construction of the item requires us to use some MDF core plywood in order to prevent shrinking or expanding that could be detrimental to the integrity of the piece. There are many different types of plywood cores including veneer core, MDF core and Particle board however all of these are considered plywood which means a veneered piece of wood over a substrate. The reason MDF core is used in a lot of the furniture industry including kitchen cabinets is that it is considered the premier "plywood" to use due to it having a more consistent flat surface. Veneer core can have a "rippling" effect because it is softer in some spots than others making a smooth surface difficult to achieve. Also veneer core plywood will still have a tiny bit of movement where MDF core will not.

CARING FOR YOUR FUSION DESIGNS FURNITURE

Your new furniture is a reflection of your good taste. It combines nature's best materials with our Amish craftsmanship. To assure that your investment becomes a treasured heirloom to withstand the test of time, take the same care in maintaining the beauty of your furniture as you took in selecting it.

“Beautiful!”

PLACEMENT

Carefully consider where your new furniture is located in your home. Avoid setting it directly in front of radiators, heating vents, or wood-burning stoves as dry air can cause wood to dry out and crack.

HUMIDITY

The ideal indoor humidity range for solid wood furniture is 35-45%. An uncontrolled environment causes expansion and contraction which leads to splitting of the grain pattern or joints and gapping where leaves fit into the table. These conditions should be appreciated as inherent characteristics of solid wood and should not be assumed to be a defect in materials or workmanship.

PROTECTION & CLEAN UP

Simply dust furniture often with a soft cloth taking care to follow the grain pattern. Periodically clean with a mild, non-alkaline soap and water using a soft cloth or sponge. Dry immediately with a soft cloth and lightly buff wood grain. Avoid nail polish remover, alcohol, or other solvents. A high-quality furniture polish may be used occasionally, but do not use polishes that contain silicones. Your retailer can recommend a polish or wax.

LEAF STORAGE

Store extra table leaves in or close to table to maintain consistent environmental conditions (not in a damp basement or dry attic). By following these simple tips, you'll get many years of enjoyment from your new furniture and when you are ready to pass it on, the new owner's first word is sure to be, “Beautiful!”



You will need to register with us as the original owner of Fusion Designs furniture. Should the properly maintained furniture fail at any time during the ownership and lifetime of the original owner because of workmanship or materials defect, we will either repair or replace it upon our discretion. This warranty does not apply to damage due to normal use, misuse, neglect or abuse, exposure to extreme heat, cold or humidity or to damage done in transit. Customer is responsible for freight costs to and from the factory. Fusion Designs is not responsible for gapping or seasonal cracking on items after two years of age. One year warranty on all electronics. There is no warranty on custom items.

WOOD SPECIES & FINISHES



RED OAK

Red Oak has a pronounced open grain with an orange/reddish hue with the sapwood being white to light brown. The stain absorbs into this open grain pattern becoming darker where the grain is close and lighter where the grain is more open.

DURABILITY

Very durable with good wear-resistance, with a 1290 rating on the Janka Hardness scale*. The grain pattern can help hide minor dents and wear.



BROWN MAPLE

Brown Maple has a smooth grain pattern and is characterized by the varying brown, tan, white, and cream streaks. It absorbs medium to dark stains well and its smooth surface is ideal for painted finishes.

DURABILITY

It is a softer hardwood so it is more prone to scratches and denting with heavy use. It has a rating of 950 on the Janka Hardness scale*.



1/4 SAWN WHITE OAK

Quarter Sawn White Oak has a unique grain pattern which is achieved by cutting the wood at a 90 degree angle to the tree's growth rings which exhibits a tight grain with cooler white to sage tones, and absorbs stains richly and evenly.

DURABILITY

Very durable with good wear-resistance with a rating of 1360 on the Janka Hardness scale*. The grain pattern can help hide minor dents and wear.



CHERRY

Cherry has a softer, circular grain pattern with minimal knots and pits throughout and slight white, brown, and deep red color variations throughout the wood. Over time the wood will darken with exposure to light and heat.

DURABILITY

Because it is softer hardwood, it is more prone to denting with heavy use. It has a rating of 950 on the Janka Hardness scale*.



RUSTIC CHERRY

Rustic Cherry has a softer, circular grain pattern with knots and pits throughout and contrasting white, brown, and deep red color variations throughout the wood. Over time the wood will darken with exposure to light and heat.

DURABILITY

Because it is a softer hardwood, it is more prone to denting with heavy use. It has a rating of 950 on the Janka Hardness scale*.



RUSTIC HICKORY

Rustic Hickory has a predominant grain pattern with knots and burls and contrasting reddish, cream and dark brown colors.

DURABILITY

It is the strongest wood type that we offer with a rating of 1820 on the Janka Hardness scale*. The grain pattern can help hide minor dents and wear.



RUSTIC WHITE OAK

Compared to red oak, on the average, white oak is heavier, stronger, and frequently darker in color. White oak has much larger (longer and wider) ray cells (1/2 inch long in red and 1-1/2 inches or longer in white), giving white oak a very strong ray fleck pattern.

DURABILITY

White oak wood has many desirable properties, including natural decay resistance, very high strength, and is impervious to liquids and ranks at 1360 on the Janka Hardness Scale and wear.

FINISH COLORS

*Walnut is a 30% upcharge from Cherry cost

*Elm wood is available at quartersawn price Available on table tops, case good tops and chair seats only

#01 Quartersawn White Oak



Asbury #30	Michaels #32	Toffee #99	Oatmeal #113	Harbor Gray #115

This cut differs from traditional cutting of oak as it is made parallel to the wood's age rings instead of across. This cut yields a board with amazing strength, much less likely to crack, check or warp than when it is flat sawn. White Oak produces a distinctive "stripping" which gives pieces a more antique look.

***JANKA HARDNESS SCALE**
This number helps determine how well a wood will withstand dents, dings, and wear. The higher the number the more durable the wood is.

#02 Oak



Michaels #32	Medium #33	Mocha #70	Toffee #99	Pebble #100	Oatmeal #113	Autumn #51	Onyx #49	Cider #116	Harbor Gray #115

Oak is a heavy, strong, light colored hardwood. Prominent rings and large pores give oak a coarse texture and prominent grain.

#03 Brown Maple



Asbury #30	Michaels #32	Black #44	New Century #45 distressed	White #46	Onyx #49	Antique Black #59	Chocolate #65	Hazelnut #68	Mocha #70	Shale #86	Toffee #99	Eucalyptus #122

Indicates 15% upcharge

Dew #103	Oatmeal #113	Aged Mineral #114	Harbor Gray #115

*Lighter colors will show more noticeable variation in color due to wood grain

This wood is cut from the center of various soft maple trees and not a specific species of tree. As it's from the center of the tree, it tends to run a range of colors from light to beige to medium brown. It's a smooth wood often finished with paint or darker finishes.

#04 Cherry



Asbury #30	Michaels #32	Autumn #51	Chilton #52	Washington #54	Hazelnut #68

A moderately hard, strong, closed grain, light to red-brown wood, cherry tends to resist warping and checking. Cherry is often used in fine furniture and cabinetry and looks great on colors ranging from light to dark. Cherry wood is also known to have small mineral deposits or character marks, these are not considered a defect.

#05 Rustic Cherry



* No longer will be sent out as a sample, but will be available to order (color is the same as Cherry but it would have rustic knots)

Rustic Cherry has the same properties as cherry wood. The rustic refers to the character marks that are noticeable in this cut of wood which can include worm holes, pits, knots, open grain and multiple marks. Knot holes will be filled on tops and chair seats only.

#06 Rustic Hickory



Hickory is one of the heaviest and hardest woods available. It has a close grain without much figure. Hickory wood is often finished in lighter or natural. The rustic refers to the character marks that are noticeable in this cut of wood which can include worm holes, pits, knots, open grain and multiple marks. Knot holes will be filled on tops and chair seats only.

#18 Rustic White Oak



FINISHING OPTIONS

Distressed Option



Distressing can be added to create a worn or aged look to your furniture. Our distressing process is carefully created using hand tools such as handplanes, hammers and nails giving your furniture natural looking worm holes, dents, cracks and natural worn edges.

Two Tone

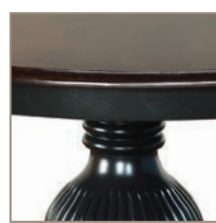

Customize your color combination by going with a two tone finish. Chair seats, table tops and case good tops can be a different color than the rest of the item, making this piece unique!

Painted Color Option

Fusion Designs also has painted colors available to help accent that special piece. Although paints are durable, it is not recommended for use on table tops.

Matte Finish Option

Fusion Designs also offers a matte option that creates a dull, flat finish. This means it will reflect very little light and will lack highlights and gloss.

FINISHING STANDARDS

Fusion Designs' modern finishing plant offers a wide variety of finishes including paint alternatives. Conversion varnish is applied to all surfaces to provide the best protection and durability. We use stains, sealers and lacquers with low VOC and HAPS to lessen the impact on the environment.

Fusion Designs uses a "secret" ingredient when mixing their varnish that results in the smooth, warm texture of the finished product. Our dealers have noted that if wearing a blindfold, they could pick out a Fusion Designs item from their floor just by the touch!

Although we try to match the colors shown here as close as possible to the actual woods and finishes, a color sample should be ordered to assure accuracy in colors. Finishes depicted here are paired with the wood & color combinations that are shown on samples. However, all woods shown can be paired with any of the listed colors even if not shown. We also recommend ordering a color sample if choosing a finish/wood combo that is not displayed on a sample.

Superior Stain Resistance

In independent testing with criteria similar to KCMA specifications, the finishes primarily used by Fusion Designs exhibited superior performance in resisting stains.

Chemical	Effect
Water	No Effect
Ethanol (50% in H ₂ O)	No Effect
Coffee (black)	No Effect
Vinegar	No Effect
Lemon juice	No Effect
Orange juice	No Effect
Grape juice	No Effect
Ketchup	No Effect
Olive oil	No Effect
Detergent solution	No Effect
Mustard*	No Effect
Soft drink	No Effect
Whiskey	No Effect
Shoe polish	Slight stain
Ethyl alcohol (100%)	Slight softening
Iodine	Stain

*Mustard test was 1 hour – all others were 24 hours

DISPLAYS

The dining room design center and the bar chair display are available for qualifying retailers. Please ask your representative for details.



Fusion Designs Dining Room Display

#1KD

Approximately: 24" w x 24" d x 80" h

The kiosk allows the customer to experiment with various wood stain colors, wood species, along with leg and hardware options. The swivel-leg design allows you to line up your leg choice with optional edge profiles.



Internet Policy

Dear Valued Customer,

It has come to our attention that Fusion Designs tables are being offered for sale on the internet at prices that we consider too low. This has caused a great deal of dissatisfaction among our customers, because of the inability to have a level playing field.

A key component of the success of Fusion Designs has been a quality presentation of our products and a corresponding sales approach that provides the consumer with all of the information necessary to make a truly informed purchase decision. We have always believed that an essential ingredient of our success is the personal interaction between well-trained sales personnel and the retail consumer.

An integral part of ensuring consumer satisfaction is prompt and responsible warranty service. If our tables are sold through the internet to locations remote from that of the actual dealer, the quality of such follow up service usually is inadequate and our image with the consumer could be damaged. It is the dealer's responsibility to take care of such warranty issues.

In light of all the factors stated above, it is our preference that our product is sold in a retail store. However, because of having responsible dealers who sell on the internet at fair prices, we feel we cannot ban internet sales.

Therefore, in order to be fair to everyone, we will require that all online pricing have a new MAP of 120% off of our FINISHED pricelist. This includes sales that you may be running. Failure to comply with this requirement risks termination of dealership.

Here are a few guidelines for advertising our product on the internet: You may not promote "free shipping." Shipping needs to be an added cost, in addition to our required selling price. You should not advertise that you have lower prices because you have no overhead costs. Any reports of an internet company directing customers to a retail store to see furniture, with the intention of buying via the internet because of price, will result in termination of dealership.

We are confident that you will join us in appreciating the long-term benefits of this policy, which is effective immediately.

Sincerely,

Fusion Designs

DINING OPTIONS

Revive the art of conversation by gathering your family and friends for meals in your custom – furnished dining room. Handcrafted furniture by Fusion Designs reflects your personal style, your high quality standards and your great eye for detail. We design our furniture for the way you live.

**YOUR HOME
IS YOUR CANVAS.**



AMARILLO *collection*

COLLECTION FEATURES

- Available in sizes: 30"x 72", 30"x 84", 30"x 96", 30"x 108", 30"x 120"
- 72" comes with 2 column base
- 84", 96", 108", and 120" come with 3 column base
- 1 3/8" saw cut top standard (this style top is not available on any other tables)

- Iron Black Powder coated finish
- Also available in smooth top
- Mission edge is standard
- Not available in any other sizes
- Not available with leaves

SUGGESTED CHAIR

Richfield Side Chair

#NC-9036SCW

19 1/2"w x 17 1/2"d x 41"h



Top is standard with **Saw Cut Style Top**



Amarillo Table

Table-#AOTB 3096 TM EM

Table Height: 30 3/8"

Popular Sizes:

#AOTB3072 30"x 72"

#AOTB3084 30"x 84"

#AOTB3096 30"x 96"

#AOTB30108 30"x 108"

#AOTB30120 30"x 120"

Shown in Rustic Cherry with Natural Matte Finish



Arabella Side Chair

#ARSCF

18 3/4" w x 17" d x 35 1/4" h



60" x 60" x 1 3/8" Round top
(6060T138TR) with Arabella
single pedestal (ARTB) and a
Bevel edge profile (EB)

**Arabella 60" Round
Pedestal Table**

Table-#ARTB 6060T138 TR EB

Table Height: 30 3/8"

Base will accommodate tops in
sizes 48" x 48" - 72" x 72". Max top
size 72" with leaves installed.

Popular Sizes:

#ARTB4848T138 48" x 48"

#ARTB5454T138 54" x 54"

#ARTB6060T138 60" x 60"

#ARTB7272T138 72" x 72"

Solid Top Only

Choice of 12" or 16" leaf

36" round tables are not
available with BBS slide upgrade

ARABELLA *collection*

COLLECTION FEATURES

- Constructed with solid hardwoods

COLLECTION OPTIONS

- Distressed finish (#2D)
- Two-tone finish (#2TN)

Table Options

- See page 210 for customization and self storing information



Shown in Brown Maple with #30 Asbury

BARTLETT *collection*

COLLECTION FEATURES

- Constructed with solid hardwoods

Buffet Features

- Soft-closing, full extension, undermount drawer slides
- Soft closing doors
- Dovetailed, solid wood drawers
- Adjustable wood shelves in door
- Wine rack

COLLECTION OPTIONS

Table Options

- See page 210 for customization and self storing information

Buffet Options

- See hardware page in Features & Options section

Bartlett Arm Chair

#BRARW

24"w x 17"d x 38 1/4"h



Bartlett Side Chair

#BRSCW

19 1/4"w x 17"d x 38 1/4"h



Shown in Brown Maple
with # 51 Autumn Finish



*1 shelf per section

Bartlett Buffet (2 Door, 4 Drawer)
 #BRBF54
 20" w x 54" d x 40" h
 Buffet Top: 54" w

Bartlett Buffet (2 Door, 4 Drawer)
 #BRBF72
 20" w x 72" d x 40" h
 Buffet Top: 72" w

Bartlett Buffet (4 Door, 4 Drawer without wine rack)
 #BRBF460
 20" w x 60" d x 40" h
 Buffet Top: 60" w

Bartlett Buffet (2 Door, 4 Drawer)
 #BRBF60
 20" w x 60" d x 40" h
 Buffet Top: 60" w

Bartlett Buffet (4 Door, 4 Drawer without wine rack)
 #BRBF454
 20" w x 54" d x 40" h
 Buffet Top: 54" w

Bartlett Buffet (4 Door, 4 Drawer without wine rack)
 #BRBF472
 20" w x 72" d x 40" h
 Buffet Top: 72" w



Bartlett Table
 Table-#BRTB 4272T138 TM EM
 Table Height: 30 3/8"
 Base will accommodate tops in sizes 36" x 60"-72" x 72".
 Max top size 120" with leaves installed.

Popular Sizes:
 #BRTB4272T138 42" x 72"
 #BRTB4872T138 48" x 72"
 Choice of 12" or 16" leaf

42" x 72" x 1 3/8" Mission top (4272T138TM) with Bartlett Double pedestal (BRTB) and a Mission edge profile (EM)

BOWIE *collection*

COLLECTION FEATURES

Bowie Features

- Round top is standard
- Underbevel edge is standard
- 1" thick top is standard



SUGGESTED CHAIR

Tarra Side Chair

18 1/2" w x 20" D x 31" h

#TASCF Fabric

#TASCL Leather



Bowie Table

Table-#BETB 4242 TR EU

Max top size 66" with
leaves installed.

Popular Sizes:

#BETB3636 36"

#BETB4242 42"

#BETB4848 48"

#BETB5454 54"

Choice of 12" or 16" leaf
or 18" butterfly leaf

36" round tables are not
available with BBS slide upgrade

Shown in Brown Maple with #65 Chocolate finish

BOWIE PUB *collection*

COLLECTION FEATURES

Bowie Pub Features

- Available sizes are 36", 42", or 48" Round
- Available only in 36" tall (42" tall not available)
- Underbevel edge is standard
- Pub only available as solid top
- Pub table top will be built without apron



Bowie Pub Table

Table- #BETB 4242 TR EU TLC

Popular Sizes:

#BETB3636TLC 36"

#BETB4242TLC 42"

#BETB4848TLC 48"

Choice of 12" or 16" leaf
or 18" butterfly leaf

36" round tables are not
available with BBS slide upgrade

Shown in Brown Maple with #65 Chocolate finish

BRIDGEPORT *collection*

COLLECTION FEATURES

– Constructed with solid hardwoods

Chair Features

- Bench-built construction
- Glued mortis and tenon joints
- Accurately leveled for stability

COLLECTION OPTIONS

Table Options

- See page 210 for customization and self storing information



42" x 42" x 1" Round top (4242TR) with Bridgeport Single pedestal (BTTB) and a Roundover edge profile (ER)

Bridgeport Table

Table-#BTTB 4242 TR ER

Base will accommodate tops in sizes 36" x 36" - 60" x 60". Max top size 66" with leaves installed.

Popular Sizes:

- #BTTB3636 36"
- #BTTB4242 42"
- #BTTB4848 48"
- #BTTB5454 54"
- #BTTB6060 60"

Choice of 12" or 16" leaf or 18" butterfly leaf

36" round tables are not available with BBS slide upgrade

Bridgeport Side Chair

#BTSCW

17" w x 16 1/2" d x 37 1/2" h



Shown in Brown Maple with #32 Michael's Cherry Finish

BRIDGEPORT DOUBLE PEDESTAL

collection

COLLECTION FEATURES

– Constructed with solid hardwoods

COLLECTION OPTIONS

Table Options

– See page 210 for customization and self storing information



Hatfield Side Chair
#HASCW
18 1/2" w x 16 1/2" d x 37 1/2" h



42" x 72" x 1" Banquet top
(4272TBT) with Bridgeport
Double pedestal (BTDTB) and
a Roundover edge profile (ER)

Bridgeport Double Pedestal Table

Table-#BTDTB 4272 TBT ER

Base will accommodate tops in sizes 36" x 60" - 72" x 72". Max top size 120" with leaves installed.

Popular Sizes:

#BTDTB3660 36" x 60" #BTDTB4866 48" x 66"
#BTDTB4266 42" x 66" #BTDTB4872 48" x 72"
#BTDTB4272 42" x 72"

Choice of 12" or 16" leaf



Shown in Brown Maple with #49 Onyx

CAPE COD PUB *collection*

COLLECTION FEATURES

– Constructed with solid hardwoods

Table Features

– Base features 2 drawer for 30" height tables, 3 drawer for 36" height, and 3 drawer for 42" high

Chair Features

– Standard seat height is 24"

COLLECTION OPTIONS

– Distressed finish (#2D)

– Two-tone finish (#2TN)

Table Options

– See page 210 for customization and self storing information



Shown in Rustic Hickory with #58 Peanut

Cape Cod Bar Chair
#CDBSW
25" w x 18" d x 40" h



48" x 48" x 1" Mission top with 1 butterfly leaf (48481BTM) with 36" tall Cape Cod pedestal (CDTB) and a Mission edge profile (EM)



Cape Cod Table
Table-#CDTB 48481B TM EM

Base will accommodate tops in sizes 48" x 48"-72" x 72". Max top size 72" with leaves installed.

Popular Sizes:

#CDTB4848 48" x 48"

#CDTB4860 48" x 60"

Choice of 12" or 16" leaf or 18" butterfly leaf

Table is standard with 3 drawers and 36" tall

CASPIAN *collection*

COLLECTION FEATURES

- Constructed with solid hardwoods

Trestle Table Features

- Top features 1 3/8" thick, plank style top

Single Table Features

- 1 3/8" thick smooth top is standard
- Round top is standard
- Mission edge is standard

Hutch Features

- Flush doors with light guard
- Antique glass sides
- Leaded glass doors
- Open deck
- Touch lighting
- 1 adjustable glass shelf w/ plate groove in top
- Fixed shelf in base
- Soft closing undermount drawer guide
- Soft closing doors
- Dovetailed solid wood drawers

COLLECTION OPTIONS

Table Options

- See page 210 for customization and self storing information

Hutch Options

- Hardware options (see Features & Options section)
- Mirror Back (#MB)
- Silverware Drawer insert (#SRD)



Caspian Standard Bench

(not shown)

36" w - #CPBEN36

48" w - #CPBEN48

60" w - #CPBEN60

72" w - #CPBEN72

Caspian Expandable Bench

#CPEXB

48-96" w x 13" d x 18" h

See Features & Options section for expectations and details on plank tops.



Shown in Rustic Cherry with
#74 Rustic Bourbon Distressed



Caspian Arm Chair
#CPACL
24" w x 17" d x 39" h



Caspian Side Chair
#CPSCS
19" w x 17" d x 39" h



Caspian Single Table
Table-#CPSTBT 1384242 TR EM
Table Height: 30 3/8"
Max top size 72" with leaves installed.
Popular Sizes:
#CPSTBT1384242 42"
#CPSTBT1384848 48"
#CPSTBT1385454 54"
#CPSTBT1386060 60" Solid Top Only
Choice of 12" or 16" leaf
36" round tables are not available with BBS slide upgrade

Shown in Brown Maple
with #30 Asbury Finish

CASPIAN *collection*

CONTINUED...

Caspian Hutch

#CPBFT40 (2-door)
42 1/2" w x 20" d x 46" h

#CPBFT60 (3-door)
60 1/2" w x 20" d x 46" h

#CPBFT80 (4-door)
80 1/2" w x 20" d x 46" h

Caspian Buffet

#CPBFB40 (2-door)
40" w x 20" d x 34" h
Buffet Top: 40" w

#CPBFB60 (3-door)
58" w x 20" d x 34" h
Buffet Top: 58" w

#CPBFB80 (4-door)
78" w x 20" d x 34" h
Buffet Top: 76" w



- *1 fixed shelf in base
- *1 adjustable glass shelf w/ plate groove in top



Caspian Table
iron detail



Caspian Table

Table-#CPTB 4272P1 TM EM
Table Height: 30 3/8"
Base will accommodate tops in sizes
36" x 60" - 72" x 72". Max top size 120"
with leaves installed.

Popular Sizes:

#CPTB4272P1 42" x 72"
#CPTB4872P1 48" x 72"

Choice of 16" leaf

42" x 72" x 1 3/8" Planked mission
top (4272P1TM) with Caspian
Double pedestal (CPTB) and a
Mission edge profile (EM)

CELINA *collection*

COLLECTION FEATURES

- Constructed with solid hardwoods

Buffet Features

- Soft-closing, full extension, undermount drawer slides
- Soft closing doors
- Dovetailed, solid wood drawers
- Radius doors
- 1 shelf per door stationary
- If no wine rack, 1 shelf in center

COLLECTION OPTIONS

Table Options

- See page 210 for customization and self storing information

Buffet Options

- See hardware page in Features & Options section



Celina Side Chair
#CLSCF
19"w x 17"d x 39"h



Shown in Quartersawn with #100 Pebble finish

CELINA *collection*

CONTINUED...

Celina Buffet
(4 door, 1 drawer)

#CLBF54
20" d x 54" l x 40" h
Buffet Top: 54" w

Celina Buffet
(4 door, 1 drawer)

#CLBF60
20" D x 60" l x 40" h
Buffet Top: 60" w

Celina Buffet
(4 door, 1 drawer)

#CLBF72
20" d x 72" l x 40" h
Buffet Top: 72" w

*1 shelf per door stationary
*If no wine rack, 1 shelf in cater



60" x 60" x 1 3/8" Round top
(6060T138TR) with Celina single
pedestal (CLTB) and a Ogee edge
profile (EO)

Celina Table

Table-#CLTB 6060T138 TR EO

Table Height: 30 3/8"

Base will accommodate tops in sizes 48" x 48" -
72" x 72". Max top size 72" with leaves installed.

Popular Sizes:

#CLTB48T138 48"

#CLTB54T138 54"

#CLTB60T138 60"

#CLTB72T138 72" Solid Top Only

Choice of 12" or 16" leaf

36" round tables are not
available with BBS slide upgrade

CHARLESTON *collection*

COLLECTION FEATURES

- Constructed with solid hardwoods
- 1" thick tops

Sedona Side Chair
#SASCW
19" w x 17" d x 38" h



Shown in Cherry with
#51 Autumn

CHARLESTON *collection*

CONTINUED...

Charleston Pub Table

Table-#CNTBTLC 4242 TR EM

Base will accommodate tops in sizes 42" x 42" - 60" x 60". Max top size 66" with leaves installed.

36" round tables are not available with BBS slide upgrade

42" x 42" x 1" Round top (4242TR) with Charleston single pedestal counter height (CNTBTLC) and a Mission edge profile (EM)



Charleston Table

Table-#CNTB 4242 TR EM

Base will accommodate tops in sizes 42" x 42" - 60" x 60". Max top size 66" with leaves installed.

Popular Sizes:

#CNTB4242 42"

#CNTB4848 48"

#CNTB5454 54"

#CNTB6060 60"

-Solid Top Only

Choice of 12" or 16" leaf or 18" butterfly leaf

36" round tables are not available with BBS slide upgrade

42" x 42" x 1" Round top (4242TR) with Charleston single pedestal (CNTB) and a Mission edge profile (EM)

CLASSIC *collection*

COLLECTION FEATURES

- Constructed with solid hardwoods
- 1" thick tops

Buffet & Hutch Features

- Soft-closing, full extension, undermount drawer guides
- Dovetailed, solid wood drawers
- Recessed touch lighting
- Beveled glass doors are standard
- 1 fixed shelf in base
- 1 glass shelf w/ plate groove in top
- Soft-close doors

COLLECTION OPTIONS

- Distressed finish (#2D)
- Two-tone finish (#2TN)

Table Options

- See page 210 for customization and self storing information

Buffet & Hutch Options

- See hardware page in Features & Options section
- Silverware drawer insert (#SRD)
- Mirror back available
- Available with 2 doors (40" wide), 3 doors (56" wide) or 4 doors (72" wide)

Kennebec Side Chair

#KCSCW
19 1/2" w x 19" d x 42" h

Kennebec Arm Chair

(not shown)
#KCACW
25" w x 19" d x 42" h



"STOCK
ITEMS
READY FOR
IMMEDIATE
SHIPPING"



Shown in Brown Maple with #30 Asbury

CLASSIC *collection*

CONTINUED...



Leg options L to R

(top square leg dimensions):

- #L1 Brookline (2 3/8")
- #L2 Englewood (3")
- #L3 Farmer (3 1/2")
- #L4 Hoosier (3")
- #L7 Mission (3")
- #L8 Regular (3")
- #L9 Round Shaker (3")
- #CCTB Classic Shaker L10 (3")



Classic Table

Table-#CCTB 4266 TM EB

Base will accommodate tops in sizes 36" x 36" - 72" x 72". Max top size 216" with leaves installed.

Popular Sizes:

- | | |
|---------------------|---------------------|
| #CCTB3648 36" x 48" | #CCTB4860 48" x 60" |
| #CCTB3654 36" x 54" | #CCTB4866 48" x 66" |
| #CCTB3660 36" x 60" | #CCTB4872 48" x 72" |
| #CCTB4260 42" x 60" | #CCTB6060 60" x 60" |
| #CCTB4266 42" x 66" | #CCTB7272 72" x 72" |
| #CCTB4272 42" x 72" | |

Choice of 12" or 16" leaf or 18" butterfly leaf

42" x 66" x 1" Mission top (4266TM) with Shaker legs (CCTB) and a Bevel edge profile (EB)

*Butterfly leaf only available with Mission shaped top (TM)



Classic Hutch

#CCBFT40 (2-door) 40" w x 20" d x 46" h
 #CCBFT56 (3-door) 56" w x 20" d x 46" h
 #CCBFT72 (4-door) 72" w x 20" d x 46" h

Classic Buffet

#CCBFB40 (2-door) 40" w x 20" d x 34" h, Buffet Top: 38 7/8" w
 #CCBFB56 (3-door) 56" w x 20" d x 34" h, Buffet Top: 56 3/8" w
 #CCBFB72 (4-door) 72" w x 20" d x 34" h, Buffet Top: 72" w

- *1 fixed shelf in base
- *1 glass shelf w/ plate groove in top



Classic Arm Chair

#CCACW
 25 1/2" w x 17 3/4" d x 42" h



Classic Side Chair

#CCSCW
 18" w x 17 3/4" d x 42" h

COPENHAGEN *collection*

COLLECTION FEATURES

- Mission edge is standard
- No optional table shapes or edges available
- Base will be used in combination with Flush skirt as shown

Leaf Storage Cabinet Features

- Available in 60" length - stores 36", 42", or 48" long leaves
- 36" standard height
- Standard depth is 19" and will need to add 6" in depth to store 16" wide leaves
- Cabinets can store up to 10 leaves with skirt
- Standard with two adjustable shelves

SUGGESTED CHAIR

Morgan Side Chair

19 1/4" w x 17" D x 34" h

#MNSCW Wood

#MNSCF Fabric

#MNSCL Leather

Morgan Arm Chair (not shown)

24 1/2" w x 17" d x 34" h

#MNACW Wood

#MNACF Fabric

#MNACL Leather



Copenhagen Table

Table-#CHTB 4266 TM EM

Max top size 120" with leaves installed.

Popular Sizes:

#CHTB4260 42" x 60"

#CHTB4266 42" x 66"

#CHTB4272 42" x 72"

#CHTB4860 48" x 60"

#CHTB4866 48" x 66"

#CHTB4872 48" x 72"

Choice of 12" or 16" leaf



Copenhagen Leaf Storage Cabinet

#CHBF60 60"

60" w x 19" d x 36" h



Shown in Brown Maple with #65 Chocolate finish

EDMONTON *collection*

COLLECTION FEATURES

- Constructed with solid hardwoods
- 1" thick tops

Hutch & Buffet Features

- Soft-closing, full extension, undermount drawer slides
- Dovetailed, solid wood drawers
- Inset doors and drawers are standard
- 2 adjustable glass shelves
- Recessed touch lighting
- Adjustable wood shelf in base
- Soft-close doors

COLLECTION OPTIONS

- Distressed finish (#2D)
- Two-tone finish (#2TN)

Table Options

- See page 210 for customization and self storing information

Hutch & Buffet Options

- See hardware page in Features & Options section
- Silverware drawer insert (#SRD)

Edmonton Side Chair
#ENSCW
18"w x 17"d x 38"h



"STOCK
ITEMS
READY FOR
IMMEDIATE
SHIPPING"



Shown in Brown Maple with #99 Toffee

EDMONTON *collection*

CONTINUED...

Edmonton Corner Hutch
#ENBFT
46" w x 25" d x 53" h

Edmonton Corner Buffet
#ENBFB
46" w x 25" d x 36" h

Standard hardware is E-5



Edmonton Table

Table-#ENTB 4242 TR EM

Base will accommodate tops in sizes 36"x36"-60"x60". Max top size 66" with leaves installed.

Popular Sizes:

#ENTB3636 36"

#ENTB4242 42"

#ENTB4848 48"

#ENTB5454 54"

Choice of 12" or 16" leaf or 18" butterfly leaf

36" round tables are not available with BBS slide upgrade

42" x 42" x 1" Round top (4242TR) with Edmonton single pedestal (ENTB) and a Mission edge profile (EM)

ELARA *collection*

COLLECTION FEATURES

- Constructed with solid wood
- 1" Thick Tops

Table Features

- Base will be used in combination with detailed skirt as shown

Buffet & Hutch Features

- Soft-closing, full extension, undermount drawer guides
- Dovetailed, solid wood drawers
- Recessed touch lighting
- Soft-close doors
- Display chest includes 2 adjustable glass shelves
- Door chest includes 2 adjustable shelves
- Shelf chest includes 2 adjustable shelves that can be used as wine bottle holders or regular shelves

COLLECTION OPTIONS

- Distressed finish (#2D)

Table Options

- See page 210 for customization and self storing information

Hutch & Buffet Options

- See hardware page in Features and Options section



Elara Side Chair

#EASC - Fabric

#EASCL - Leather

18 1/2" w x 16 3/4" d x 38" h



Shown in Brown Maple with #103 Dew

ELARA *collection*

CONTINUED...



54" x 36" x 1" w/1-18"
Butterfly Leaf and
Mission top (54361BTM)
with Elara legs Counter
Height (EATBTLC) and an
underbevel edge profile (EU)



Elara Bar Chair

#EA24
18 1/2"w x 16 3/4"d x 44"h
#EA24 - 24" Fabric
#EA24L - 24" Leather

#EA30
18 1/2"w x 16 3/4"d x 50"h
#EA30 - 30" Fabric
#EA30L - 30" Leather

Elara Pub Table

Table-#EATBTLC 54361B TM EU

Base will accommodate tops in sizes
36"x36"-72"x72". Max top size 216" with
leaves installed.

Popular Sizes:

#EATB36TLC 54"w x 36"d x 36"h Tall
#EATB42TLC42 54"w x 36"d x 42"h Tall

Choice of 18" butterfly leaf



Elara Dining Table

Table-#EATB 4284 TM EU

Base will accommodate tops in sizes 36"x36"-
72"x72". Max top size 216" with leaves installed.

Popular Sizes:

#EATB3648 36"x48" #EATB4284 42"x84" Solid Top Only
#EATB3654 36"x54" #EATB4860 48"x60"
#EATB3660 36"x60" #EATB4866 48"x66"
#EATB4260 42"x60" #EATB4872 48"x72"
#EATB4266 42"x66"
#EATB4272 42"x72" Choice of 12" or 16" leaf or 18" butterfly leaf

42" x 84" x 1" Mission top
(4284TM) with Elara legs
(EATB) and an underbevel
edge profile (EU)



Elara Display Chest
 #EADPC
 40" w x 19" d x 78" h

For same hardware in brushed nickel color, specify 7975384195 Hardware choice.

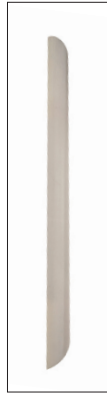

Elara Shelf Chest
 #EASC
 38" w x 18" d x 38" h



Elara Door Chest
 #EADC
 38" w x 18" d x 38" h



Shelves can be reversed for wine bottle storage



Individual units can be combined to form 1 large buffet

ELLIOT *collection*

COLLECTION FEATURES

Trestle Table Features

- 1" thick top is standard
- Large Cove edge is standard
- Mission shape top is standard

Single Table Features

- 1" thick top is standard
- Large Cove Edge is standard

SUGGESTED CHAIR

Richfield Side Chair

#NC-9036SCW

19 1/2" w x 17 1/2" d x 41" h

Richfield Arm Chair

(not shown)

#NC-9036ACW

26" w x 17 1/2" d x 41" h



Elliot Bench

- #ETBEN36 36"
- #ETBEN48 48"
- #ETBEN60 60"
- #ETBEN72 72"

Elliot Expanda Bench

#ETEXB

Elliot Round Table

#ETSTB 4848 TR EV

Max top size 72" with leaves installed.

Popular Sizes:

- #ETSTB4242 42"
- #ETSTB4848 48"
- #ETSTB5454 54"
- #ETSTB6060 60"

Choice of 12" or 16" leaf or 18" butterfly leaf

Shown in Brown Maple with #45 New Century finish

36" round tables are not available with BBS slide upgrade



Elliot Trestle Table

#ETTB 4272 TM EV

Max top size 120" with leaves installed.

Popular Sizes:

- #ETTB4260 42" x 60"
- #ETTB4266 42" x 66"
- #ETTB4272 42" x 72"
- #ETTB4872 48" x 72"

Choice of 12" or 16" leaf

Shown in Brown Maple with #103 Dew finish

FARMVILLE *collection*

COLLECTION FEATURES

- Constructed with solid wood

Trestle Features

- Mission top
- 1³/₈" thick top
- Mission edge profile

Single Pedestal Features

- Mission edge profile
- 1³/₈" thick top
- Minimum top size 42"
- Round top
- Max. length 66" with leaves included

Buffet Features

- Soft-Closing, full extension, undermount drawer slides
- Soft closing doors on buffet only
- Dovetailed, solid wood drawers
- 2 shelves per section in base
- Recessed touch lighting
- 2 glass adjustable shelves in top

COLLECTION OPTIONS

Table Options

- See page 210 for customization and self storing information

Buffet Options

- See hardware page in Features & Options section

Conner Side Chair

19" w x 17" d x 41" h

#CRSCW Wood

#CRSCF Fabric

#CRSCL Leather

Conner Arm Chair (not shown)

25" w x 17" d x 41" h

#CRACW Wood

#CRACF Fabric

#CRACL Leather



Shown in Rustic Cherry with #103 Dew

FARMVILLE *collection*

CONTINUED...

*2 shelves per section in base
*2 shelves in top



Farmville Hutch (2 Door)
#FEBFT
20"w x 60 1/2"d x 46 1/2"h

Farmville Hutch (1 Door)
#FEBFT35
20"w x 57"d x 35"h



Farmville Buffet (3 Drawer, 2 Door)
#FEBF
20"w x 57"d x 35"h

Farmville Buffet (1 Drawer, 2 Door)
#FEBF31
20"w x 31 1/2"d x 35"h



Farmville Single Table
Table-#FETBSP48T138 TR EM
Table Height: 30 3/8"
Max top size 72" with leaves installed.

Popular Sizes:
#FETBSP42T138 42"
#FETBSP48T138 48"
#FETBSP54T138 54"
#FETBSP60T138 60" Solid Top Only

Choice of 12" or 16" leaf

Shown in Brown Maple with #45 New Century finish

36" round tables are not available with BBS slide upgrade



42" x 72" x 1 3/8"
Mission top (4272T138TM) with Farmville Double pedestal (FETB) and a Mission edge profile (EM)

Farmville Table
Table- #FETB 4272T138 TM EM
Table Height: 30 3/8"
Base will accommodate tops in sizes 36"x60"-72"x72". Max top size 120" with leaves installed.

Popular Sizes:
#FETB4272T138 42"x72"
#FETB4284T138 42"x84" Solid Top Only
#FETB4872T138 48"x72"
#FETB4884T138 48"x84" Solid Top Only

Choice of 12" or 16" leaf

FULTON *collection*

COLLECTION FEATURES

Round Table Features

- Available 42", 48", or 54" diameter
- Round top is standard
- Bevel edge is standard

Trestle Table Features

- Rectangular top is standard
- Bevel edge is standard
- Standard top thickness is 1"



Fulton Round Table
Table-#FNSTB 4242 TR EB

Max top size 72" with leaves installed.

Popular Sizes:
#FNSTB4242 42"
#FNSTB4848 48"
#FNSTB5454 54"

Choice of 12" or 16" leaf
or 18" butterfly leaf

Shown in Brown Maple with #30 Asbury.
36" round tables are not available with
BBS slide upgrade



Fulton Bench
#FNBEN36 36"
#FNBEN48 48"
#FNBEN60 60"
#FNBEN72 72"

Fulton Expandable Bench
#FNEXB



Fulton Trestle
Table-#FNTB 4272 TM EB

Max top size 120"
with leaves installed.

Popular Sizes:
#FNTB4260 42" x 60"
#FNTB4266 42" x 66"
#FNTB4272 42" x 72"
#FNTB4872 48" x 72"

Choice of 12" or 16" leaf

Shown in Rustic Cherry with
#68 Hazelnut finish.



Gibson High Buffet
 #GBHBF44 (2-door, 4-drawer)
 44" w x 20" d x 50" h
 #GBHBF56 (3-door, 4-drawer)
 56" w x 20" d x 50" h
 #GBHBF68 (4-door, 6-drawer)
 68" w x 20" d x 50" h

Gibson Bench
 #GBBEN36 36" w x 13" d x 18" h
 #GBBEN48 48" w x 13" d x 18" h
 #GBBEN60 60" w x 13" d x 18" h
 #GBBEN72 72" w x 13" d x 18" h

Gibson Expandable Bench
 #GBEXB
 48-96" w x 13" d x 18" h



Gibson Table
 Table-#GBTB 4272 TM EB

Base will accommodate tops in sizes 36" x 36" - 72" x 72". Max top size 216" with leaves installed.

Popular Sizes:

- #GBTB3648 36" x 48"
- #GBTB3654 36" x 54"
- #GBTB3660 36" x 60"
- #GBTB4260 42" x 60"
- #GBTB4266 42" x 66"
- #GBTB4272 42" x 72"
- #GBTB4860 48" x 60"
- #GBTB4866 48" x 66"
- #GBTB4872 48" x 72"

Choice of 12" or 16" leaf or 18" butterfly leaf



42" x 72" x 1" Mission top (4272TM) with Gibson legs (GBTB) and a Bevel edge profile (EB)

GIBSON *collection*

COLLECTION FEATURES

– Constructed with solid hardwoods

Table Features

– Base will be used in combination with arched skirt as shown

Hutch Features

- Flush doors with light guard
- Multi-setting touch lights
- 1 adjustable glass shelf
- Soft closing undermount drawer guide
- Soft closing doors
- Dovetailed solid wood drawers



Gibson Side Chair

#GBSCW

19" w x 17 1/2" d x 38" h



Gibson Arm Chair

#GBACW

22" w x 17 1/2" d x 38" h



Shown in Cherry with #52 Chilton Finish

GOSHEN *collection*



42" x 72" x 1" Mission top
(4272TM) with Goshen
Double pedestal (GNTB) and
a Mission edge profile (EM)

Goshen Table

Table-#GNTB 4272 TM EM

Base will accommodate tops in sizes 36" x 60" -
72" x 72". Max top size 120" with leaves installed.

Popular Sizes:

#GNTB3654 36" x 54"

#GNTB3660 36" x 60"

#GNTB4272 42" x 72"

#GNTB4872 48" x 72"

Choice of 12" or 16" leaf



Goshen Buffet

#GNBF60

60" w x 20" d x 40" h

*1 adjustable wood shelf

GOSHEN *collection*

CONTINUED...

COLLECTION FEATURES

- Constructed with solid hardwoods
- 1" thick tops

Buffet Features

- Textured glass is standard
- One adjustable shelf in each door
- Inset doors and drawers are standard
- Soft-closing, full extension, undermount drawer slides
- Dovetailed, solid wood drawers
- Soft-close doors

Classic Side Chair

#CCSCW

18" w x 17 3/4" d x 42" h

Classic Arm Chair

(not shown)

#CCACW

25 1/2" w x 17 3/4" d x 42" h



Shown in Quartersawn Oak with #32 Michael's Cherry

HARMONY ROUND

collection

COLLECTION FEATURES

- Solid wood construction
- Round shaped top
- Available in 42", 48", and 54"
- Underbevel edge is standard

BUFFET FEATURES

- See page 132 for harmony buffet options
- Dovetailed drawer box
- Soft close slides
- Adjustable shelf
- Reversible wine glass holder shelf
- Spice rack in drawer
- Removable Fusion Designs cutting board

Harmony Round Table

Table # HYRTB4242TREU

Max top size 72" with leaves installed.

Popular Sizes:

#HYRTB4242 42"

#HYRTB4848 48"

#HYRTB5454 54"

Choice of 12" or 16" leaf
or 18" butterfly leaf



Harmony Arm Chair

#HYACW

22 1/2"w x 19 1/4"d x 36"h



Harmony Side Chair

#HYSCW

17 3/4"w x 19 1/4"d x 36"h



Harmony Buffet

#HYBF35GB

34 3/4"w x 19"d x 36"h



Harmony 65" Buffet

#HYBF65ST

65"w x 19"d x 36"h

See buffet page for more info on ordering



HARMONY TRESTLE

collection

COLLECTION FEATURES

TABLE FEATURES

- Underbevel edge
- Mission shaped top
- 1" thick solid wood top
- Self storing leaves

-42" x 72" x 1" Mission top
(4272TM) with Harmony
Trestle (HYTB) and an
underbevel edge profile (EU)



Harmony Trestle

#HYTB4272TMEU

Base will accommodate tops in sizes
42" x 72" - 48" x 72". Max top size 120" with
leaves installed.

Popular Sizes:

#HYTB4872 48" x 72"

#HYTB4272 42" x 72"

Choice of 12" or 16" leaf



Harmony 66" Bench

#HYBEN6603

66" w x 15 7/8" d x 18 3/8" h



Morgan Chair
#MNSCW
19 1/4" w x 17" d x 34" h



Morgan Arm Chair
#MNACW
24 1/2" w x 17" d x 34" h



HARMONY LEG

collection



42" x 66" x 1" Banquet top
(4266TBT) with Harmony legs
(HYL) and an Underbevel edge
profile (EU)

Harmony Leg Table

#HYLTB4266 TBTEU

42" x 66-88"

1-16" leaf

Popular Sizes:

#HYLTB3654 36" x 54"

#HYLTB3660 36" x 60"

#HYLTB4260 42" x 60"

#HYLTB4266 42" x 66"

#HYLTB4272 42" x 72"

#HYLTB4860 48" x 60"

#HYLTB4866 48" x 66"

#HYLTB4872 48" x 72"



Harlow Arm Chair

#HWACW

22 1/2" w x 19 1/4" d x 36" h

Harlow Side Chair

#HWSCW

17 3/4" w x 19 1/4" d x 36" h



Shown in Brown Maple with #115 Harbor Gray

HATFIELD *collection*

COLLECTION FEATURES

– Solid wood construction

Chair Features

- Bench built construction
- Glued mortis and tenon joints
- Accurately leveled for stability
- Leather and fabric are hand selected for consistency

COLLECTION OPTIONS

Table Options

- See page 210 for customization and self storing information

Hatfield Side Chair

#HASCW

18 1/2" w x 16 1/2" d x 37 1/2" h

- Also available with fabric or leather seat



Hatfield Table

Table-#L1 4266 TBS EB

Base will accommodate tops in sizes 36" x 36" - 72" x 72". Max top size 216" with leaves installed.

Popular Sizes:

#L1TB3654 36" x 54"	#L1TB4272 42" x 72"
#L1TB3660 36" x 60"	#L1TB4860 48" x 60"
#L1TB4260 42" x 60"	#L1TB4866 48" x 66"
#L1TB4266 42" x 66"	#L1TB4872 48" x 72"

Choice of 12" or 16" leaf

42" x 66" x 1" Boat top (4266TBS) with Brookline legs (L1) and a Bevel edge profile (EB)



Shown in Brown Maple with #32 Michael's Cherry



Features **Ebony Inlays**

Hayworth Hutch
 #HHBFT62 (3-door)
 62" w x 21 1/2" d x 46" h
 #HHBFT46 (2-door)
 46" w x 21 1/2" d x 46" h
 #HHBFT80 (4-door)
 80" w x 21 1/2" d x 46" h
 - Crown molding adds
 3" to overall width



*1 shelf in base and
 1 shelf in top



Hayworth Buffet
 #HHBFB46 (2-door)
 46" w x 21 1/2" d x 35" h
 #HHBFB62 (3-door)
 62" w x 21 1/2" d x 35" h
 #HHBFB80 (4-door)
 80" w x 21 1/2" d x 35" h



42" x 72" x 1" Boat top(4272TBS) with Hayworth Double pedestal (HHTB) and a Bevel edge profile (EB) with inlay (HI)

Inlay in base is standard. Inlay in top is optional and will be built without inlay if not noted when being ordered.

Hayworth Table
 Table-#HHTB 4272 TBS EBHI

Base will accommodate tops in sizes 36" x 60" - 72" x 72". Max top size 120" with leaves installed.

Popular Sizes:
 #HHTB4272 42"x72" No Inlay In Top
 #HHTB4272HI 42"x72" With Inlay In Top
 #HHTB4872 48"x72" No Inlay In Top
 #HHTB4872HI 48"x72" With Inlay In Top
 Choice of 12" or 16" leaf

HAYWORTH *collection*

COLLECTION FEATURES

- Constructed with solid hardwoods
- 1" thick tops
- Ebony inlays

Table Features

- Base features Ebony wooden inlay

Hutch & Buffet Features

- Recessed touch lighting
- Beveled glass doors are standard
- 1 shelf in base and 1 shelf in top
- Soft-closing, full extension, undermount drawer slides
- Dovetailed, solid wood drawers
- Soft-close doors



Hayworth High Back Arm Chair (shown)
#HHHACW
26"w x 18"d x 49"h

Hayworth Arm Chair
#HHACW
26"w x 18"d x 43"h



Hayworth Side Chair (shown)
#HHSCW
19"w x 18"d x 43"h

Hayworth High Back Side Chair
#HHHSCW
19"w x 18"d x 49"h



Shown in Quartersawn Oak with #30 Asbury

Ellington Side Chair
18 1/2" w x 17" d x 41" h
Wood #ELSCW
Fabric #ELSCF
Leather #ELSCL

Ellington Arm Chair
26 1/2" w x 17" d x 41" h
Wood #ELACW
Fabric #ELACF
Leather #ELACL



Goshen Buffet
#GNBF60
60" w x 20" d x 40" h
*1 adjustable wood shelf

HEARTLAND *collection*

COLLECTION FEATURES

- Constructed with solid hardwoods
- 1" thick tops
- Mission edge is standard

Table Features

- Base splits to accommodate longer length tops and leaves

Buffet Features

- Textured glass is standard
- One adjustable shelf in each door
- Inset doors and drawers are standard
- Soft-closing, full extension, undermount drawer slides
- Dovetailed, solid wood drawers
- Soft-close doors

**Not available with BBS slides due to base style*

54" x 54" x 1" Round top (5454TR) with Heartland single pedestal (HDTB) and a Mission edge profile (EM)



Heartland Table

Table-#HDTB 5454 TR EM

Base will accommodate tops in sizes 48"x48"-72"x72". Max top size 192" with leaves installed.

Popular Sizes:

#HDTB4848 48"

#HDTB5454 54"

Choice of 12" or 16" Leaf



Table splits in center to accommodate up to 192" in length

HENNING *collection*

COLLECTION FEATURES

- Constructed with solid wood
- Egg Shaped

COLLECTION OPTIONS

Table Options

- See page 210 for customization and self storing information

Henning Side Chair
#HGSCW
18 1/2"w x 17 1/2"d x 32"h



Shown in Brown Maple with #65 Chocolate Finish



Henning Bench
 #HGBEN54
 16" w x 54" d x 18" h



Henning Table
 Table-#HGTB 4254 TE EM

Base will accommodate tops in sizes 42" x 42" – 60" x 60". Max top size 66" with leaves installed.

Popular Sizes:

- #HGTB4254 42" x 54"
- #HGTB4854 48" x 60"
- Solid Top Only

Choice of 12" leaf

36" round tables are not available with BBS slide upgrade

*Table will not accommodate 16" leaves

42" x 54" x 1" Round top (4254TE) with Henning single pedestal (HGTB) and a Mission edge profile (EM)

*42" x 54" and 48" x 60" sizes will be standard with square apron as pictured – Round table tops will receive round apron, Oval table tops will receive oval apron, in order to accommodate slides

INFINITY *collection*

COLLECTION FEATURES

- Constructed with solid hardwoods
- 1" thick tops

Infinity Table

Table-#IYTB 4242 TR EO

Base will accommodate tops in sizes 36"x36"-60"x60". Max top size 66" with leaves installed.

Popular Sizes:

#IYTB4242 42"

#IYTB4848 48"

#IYTB5454 54"

Choice of 12" or 16" leaf or 18" butterfly leaf

36" round tables are not available with BBS slide upgrade

42" x 42" x 1" Round top (4242TR) with Infinity single pedestal (IYTB) and an Ogee edge profile (EO)



Infinity Chair

#IYSCF

16 1/2"w x 16"d x 33 3/4"h



Shown in Brown Maple with #44 Black Paint

MADRID & MADRID PUB *collection*

COLLECTION FEATURES

Table Features

- Available in 38", 44", or 50" Round
- Round top is standard with flush 2" skirt
- Mission edge is standard
- Standard top thickness is 1"
- No custom sizes or shapes due to flush skirt

Pub Features

- Available in 42" and 48" round solid top
- Standard with round top without skirt
- Underbevel edge is standard
- Standard top thickness is 1"
- Standard height is 36"
- 42" high is not available

View of Madrid Bar Stool Back



Madrid Side Chair

- #MDSCF- Fabric
- #MDSCL- Leather



Madrid Bar Stool

- #MDSCF- Fabric
- #MDSCL- Leather



Shown in Brown Maple with #30 Asbury finish

MADRID & MADRID PUB

collection

CONTINUED...



Madrid Table
#MDTBM 44 TR EM

Max top size 66" with
leaves installed.

Popular Sizes:
#MDTBM38 38"
#MDTBM44 44"
#MDTBM50 50"

Choice of 12" or 16" leaves
38" round tables are not
available with BBS slide upgrade



Madrid Pub Table
#MDTBM 42TLC TR EM

Solid Top Only

Popular Sizes:
#MDTBM42TLC 42"
#MDTBM48TLC 48"

MARIA *collection*

COLLECTION FEATURES

- Solid wood construction
- Chamfer edge
- Features 1-16' leaf
- Round top is standard
- 1" thick top is standard



Harmony Arm Chair
#HYACW
22 1/2" w x 19 1/4" d x 36" h



Harmony Side Chair
#HYSCW
17 3/4" w x 19 1/4" d x 36" h



Maria Round Table
Table-#MATB4242TREC

Base will accommodate tops in sizes 36"x36" - 60"x60". Max top size 66" with leaves installed.

Popular Sizes:

MATB3636 36"
MATB4242 42"
MATB4848 48"
MATB5454 54"

Choice of 12" or 16" leaf or 18" butterfly leaf
36" round tables are not available with BBS slide upgrade



Shown in Brown Maple with #113 Oatmeal

OLD MISSION *collection*

COLLECTION FEATURES

- Round top is standard
- 1" thick top is standard
- Mission edge is standard

Livonia Desk Chair

- 25" w x 20" d x 37" h
- Fabric #LVACF
- Leather #LVACL

Caswell Gas Lift Base #CGL

- When ordering, add desk chair base style # to end of arm chair # for correct item code
- Only available on arm chairs
- Caswell Base optional



Shown in Oak with #32 Michaels

OLD MISSION *collection*

CONTINUED...

Butterfly Leaf shown below



42" x 42" x 1" Round top (4242TR) with Old Mission single pedestal (OMTB) and a Mission edge profile (EM)

Old Mission Table

Table-#OMTB 42421B TR EM

Base will accommodate tops in sizes 36" x 36" - 72" x 72". Max top size 72" with leaves installed.

Popular Sizes:

#OMTB4242 42"

#OMTB4848 48"

#OMTB5454 54"

#OMTB6060 60"

Choice of 12" or 16" leaf or 18" butterfly leaf

36" round tables are not available with BBS slide upgrade

REBECCA *collection*

COLLECTION FEATURES

- Solid wood construction
- Chamfer edge is standard
- Round Shaped Top is standard
- 1" top is standard



Rebecca Round Table

Table #RATB4242TREC
42RD

Base will accommodate tops in sizes 36" x 36" - 60" x 60". Max top size 66" with leaves installed.

Popular Sizes:

#RATB3636 36"
#RATB4242 42"
#RATB4848 48"
#RATB5454 54"

Choice of 12" or 16" leaf or 18" butterfly leaf
36" round tables are not available with BBS slide upgrade

Harper Arm Chair

#HPACW

22 1/2" w x 19 1/4" d x 36" h



Harper Side Chair

#HPSCW

17 3/4" w x 19 1/4" d x 36" h



Shown in Brown Maple with #113 Oatmeal

SALEM *collection*

COLLECTION FEATURES

- Round top is standard
- Mission edge is standard
- 1 3/8" smooth top is standard



SUGGESTED CHAIR

Richfield Side Chair

NC-9036SCW

19 1/2" w x 17 1/2" d x 41" h

Richfield Arm Chair

(not shown)

NC-9036ACW

26" w x 17 1/2" d x 41" h



Salem Table

#SLTBT 13842 TR EM

Table Height: 30 3/8"

Max top size 72" with leaves installed.

Popular Sizes:

#SLTBT13842 42"

#SLTBT13848 48"

#SLTBT13854 54"

#SLTBT13860 60"

Choice of 12" or 16" leaf

Shown in Brown Maple with
#30 Asbury finish.

36" round tables are not
available with BBS slide upgrade

SHERIDON *collection*

COLLECTION FEATURES

– Bevel edge standard

Conner Side Chair

19" w x 17" d x 41" h

#CRSCW Wood

#CRSCF Fabric

#CRSCL Leather

Conner Arm Chair

(not shown)

25" w x 17" d c 41" h

#CRACW Wood

#CRACF Fabric

#CRACL Leather



Sheridon Table

#SNTB 4272 TM EB

Max top size 120" with leaves installed.

Popular Sizes:

#SNTB4260 42" x 60"

#SNTB4266 42" x 66"

#SNTB4272 42" x 72"

#SNTB4872 48" x 72"

Choice of 12" or 16" leaf

Shown in Cherry wood with #52 Chilton finish.



SIMPLICITY *collection*

COLLECTION FEATURES

- Soft close slides
- Natural poplar drawer box with English Dovetail
- All wood species include Walnut accents

**Simplicity Side Chair
(with Inlays)**
#51-9065SCW

**Simplicity Side Chair
(without Inlays, not shown)**
#51-9065SCWNI

**Simplicity Arm Chair
(with Inlays, not shown)**
#51-9065ACW

**Simplicity Arm Chair
(without Inlays, not shown)**
#51-9065AWNI

Drawing from the streamlined looks and clean lines of mid-century modern design and the pared-down aesthetic of Scandinavian spaces, the Simplicity Collection is a contemporary interpretation of Shaker style re-imagined for today's more modern tastes. Smaller-scaled with an emphasis on flexibility, the collection is marked by angular posts and pilasters and functional open shelving that offers the fresh and airy feeling indicative of these serene, light-filled styles. Finished in a mellow Brown Maple stain coupled with tapered walnut bases, legs and contrasting walnut accents, these multi-functional dining room pieces easily move from one room to another depending on decorating needs.



Shown in Brown Maple with #99 Toffee

SIMPLICITY *collection*

CONTINUED...

**Simplicity
Solid Top Bench**
#51-36BEN

Popular Sizes:
#51-36BEN 36"
#51-48BEN 48"
#51-60BEN 60"
#51-72BEN 72"

**Simplicity
Expandable Bench**
#51-1401EXB



Simplicity Round
#51-8001 4242 TR EM

Max top size 66" with leaves installed.

Popular Sizes:
#51-80014242 42"
#51-80014848 48"
#51-80015454 54"
#51-80016060 60" Solid Top Only

Choice of 12" or 16" leaf
or 18" butterfly leaf

Top features 4 **Bowtie Inlays** located at
outside centers of table.

36" round tables are not available with
BBS slide upgrade



Simplicity Trestle
#51-8003 4272 TM EM

Max top size 120" with
leaves installed.

Popular Sizes:
#51-80034272 42"x 72"
#51-80034872 48"x 72"

Choice of 12" or 16" leaf

Top features **Bowtie Inlays**
in each corner and center.



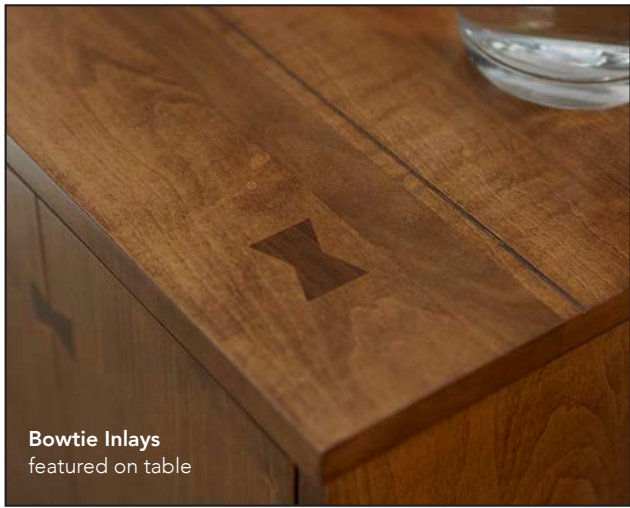

Bowtie Inlays
featured on table



Simplicity Curio Cabinet
#51-1001
38" w x 15" d x 60" h
– Features Walnut base



Simplicity Server
#51-1101
56" w x 19" d x 36" h
– Features Walnut base



Tuscana Open Buffet
 #TAOBF
 60" w x 20" d x 40"
 *1 shelf per door



Topeka Table

Table-#TATB 4242 TR ER

Base will accommodate tops in sizes 36"x36" - 60"x60". Max top size 66" with leaves installed.

Popular Sizes:

- #TATB3636 36"
- #TATB4242 42"
- #TATB4848 48"
- #TATB5454 54"
- #TATB6060 60" Solid Top Only

Choice of 12" or 16" leaf or 18" butterfly leaf

42" x 42" x 1" Round top (4242TR) with Topeka single pedestal (TATB) and a Roundover edge profile (ER)

TOPEKA *collection*

COLLECTION FEATURES

– Constructed with solid hardwoods

Buffet Features

- Soft-closing, full extension, undermount drawer slides
- Dovetailed, solid wood drawers
- Soft-close doors
- 1 shelf per door



Angola Desk Chair (Side)
#ALSCWSL
19" w x 16 1/2" d x 40" h



Shown in Oak with #33 Medium

WASILLA *collection*

COLLECTION FEATURES

– Mission edge standard

Kendall Side Chair

19" w x 18 5/8" d x 42" h

#KLSCW Wood

#KLSCF Fabric

#KLSCL Leather

Kendall Arm Chair

25" w x 18 5/8" d x 42" h

#KLACW Wood

#KLACF Fabric

#KLAFL Leather



Wasilla Bench

#WABEN36 36"

#WABEN48 48"

#WABEN60 60"

#WABEN72 72"

Wasilla Expandable Bench

#WAEXB



Wasilla Table

#WATB4272TMEM

Max top size 120"
with leaves installed.

#WATB4260 42" x 60"

#WATB4266 42" x 66"

#WATB4272 42" x 72"

#WATB4872 48" x 72"

Choice of 12" or 16" leaf

Shown in Red Oak with
#100 Pebble finish.

WASILLA Live Edge

collection



Baily Side Chair

18" w x 20 1/2" d x 34 1/2" h
-Wood #BYSCW

Fabric, leather and arm
chair not available



Beautiful live edge



Wasilla Live Edge Table

#WATB4272LE
Max top size 96"

#WATB4260LE 42" x 60"
#WATB4266LE 42" x 66"
#WATB4272LE 42" x 72"
#WATB4872LE 48" x 72"

42" x 72" x 1 3/8" Live Edge mission shape top
(42726LETM) with Wasilla double pedestal (WATB)
and a live edge profile (LE)

WELLINGTON *collection*

COLLECTION FEATURES

- Constructed with solid hardwoods
- Plank-style top with saw marks

Table Features

- Top features 1 3/8" thick plank style top

Hutch & Buffet Features

- Soft-closing, full extension, undermount drawer slides
- Dovetailed, solid wood drawers
- 1" thick top
- 1 shelf in base
- No shelves in top
- Inset doors and drawers
- Recessed, touch lighting
- Raised panel doors

Americana Chair

#AASCW

19" w x 17 1/2" d x 38" h



See Features & Options section for expectations and details on plank tops.



Shown in Brown Maple with #32 Michaels Cherry with Distressing

WELLINGTON *Collection*

CONTINUED...



54" x 54" x 1 3/8" Planked Round top (5454P1TR) with Wellington single pedestal (WNTB) and a Mission edge profile (EM)

Wellington Table

Table-#WNTB 5454 TR EM

Table Height: 30 3/8"

Base will accommodate tops in sizes 36"x36"-72"x72". Max top size 72" with leaves installed.

36" round tables are not available with BBS slide upgrade

Popular Sizes:

#WNTB4848P1 48"x 48"

#WNTB5454P1 54"x 54"

#WNTB6060P1 60"x 60" Solid Top Only

Choice 16" leaf

Wellington Hutch

#WNBFT

48"w x 20" d x 22"h

Wellington Buffet

#WNBFB

48"w x 20" d x 44"h



*1 shelf in base

*No shelves in top

Plank-style tops are standard



Wellington Trestle Table

Table-#WTTB 4272P1 TM EM

Table Height: 30 3/8"

Base will accommodate tops in sizes 36"x60"-72"x72". Max top size 120" with leaves installed.

Popular Sizes:

#WTTB4272P1 42"x72"

#WTTB4872P1 48"x72"

Choice of 16" leaf

42" x 72" x 1 3/8" Planked mission top (4272P1TM) with Wellington Double pedestal (WTTB) and a Mission edge profile (EM)

XANDER *Collection*

COLLECTION FEATURES

– Constructed with solid hardwoods



Beautiful **live edge**



Top shown in Brown Maple with #65 Chocolate
Base Shown in Brown Maple with #44 Black

XANDER *collection*

CONTINUED...



Xander Arm Chair
#XRACW
25 3/4" w x 17 1/4" d x 42 1/4" h



Xander Side Chair
#XRSCW
19" w x 17 1/4" d x 42 1/4" h



Xander Table
Table-#XRTB 4296LE TM
Table Height: 30 3/8"
Base will accommodate tops in sizes 36" x 60" - 72" x 72". Max top size 120" with leaves installed.

- Popular Sizes:**
#XRTB4272LE 42" x 72" Solid Top Only
#XRTB4284LE 42" x 84" Solid Top Only
#XRTB4296LE 42" x 96" Solid Top Only
#XRTB4872LE 48" x 72" Solid Top Only
#XRTB4884LE 48" x 84" Solid Top Only
#XRTB4896LE 48" x 96" Solid Top Only



AM2 Table
Table # AM2TB4296LE
Table Height: 30 3/8"

Base will accommodate tops in sizes 36" x 60" - 72" x 72". Max top size 120" with leaves installed.

- Popular Sizes:**
#AM2TB4272LE 42" x 72" Solid Top Only
#AM2TB4284LE 42" x 84" Solid Top Only
#AM2TB4296LE 42" x 96" Solid Top Only
#AM2TB4872LE 48" x 72" Solid Top Only
#AM2TB4884LE 48" x 84" Solid Top Only
#AM2TB4896LE 48" x 96" Solid Top Only

*Black powder coated metal base

42" x 96" x 1 3/8" Live Edge mission shape top (4296LE TM) with AM2 metal base (AM2TB) and a live edge profile

ZIGLAR *collection*

COLLECTION FEATURES

- Available in 42", 48", 54", 60", and 72" diameter
- 72" round solid top available no leaves
- Standard top thickness is 1 3/8"
- Standard edge profile is 3/4" roundover
- Standard shape is round



SUGGESTED CHAIR

Asher Side Chair

19 1/4" w x 17 1/4" d x 41" h

#AASCW Wood

#AASCF Fabric

#AASCL Leather

SUGGESTED CHAIR

Richfield Side Chair

#NC-9036SCW

19 1/2" w x 17 1/2" d x 41" h



*Not available with BBS slides due to base style – only on split pedestal



Shown in Brown Maple with #30 Asbury finish

ZIGLAR *collection*

CONTINUED...



Ziglar Split Pedestal Table

#ZRSTB 4848 T1387 TR ER

Table Height: 30 3/8"

Popular Sizes:

#ZRSTBT1384242 42"

Max top size 126" with leaves.

#ZRSTBT1384848 48"

Max top size 192" with leaves.

Choice of 12" or 16" leaves

*No BBS slides available



Ziglar Table

#ZRTB 5454 T138 TR ER

Table Height: 30 3/8"

Max top size 72" with leaves installed.

Popular Sizes:

#ZRTBT1384242 42"

#ZRTBT1384848 48"

#ZRTBT1385454 54"

#ZRTBT1386060 60"

#ZRTBT1387272 72" Solid Top Only

Choice of 12" or 16" leaf

36" round tables are not

available with BBS slide upgrade

LAZY SUSAN

COLLECTION FEATURES

- 1" thick solid wood top
- Ball bearing swivel

A rotating tray to place on a table or countertop to help organize your kitchen or dining room.

30" Lazy Susan
#LS30
30" Round

24" Lazy Susan
#LS24
24" Round



Shown in Brown Maple with #30 Asbury finish





SEATING OPTIONS

Have a seat, sit a spell, chat, relax, reminisce. Share stories of the past. Celebrate the present. Dream of a bright future. Seating by Fusion Designs will be there through it all, from generation to generation, providing comfort, durability, and lasting impressions.

**MEMORIES
BUILT TO LAST
AND SHARE.**

CHAIRS



Americana Chair

Side Chair

- 19"w x 17 1/2"d x 38"h
 – Wood #AASCW
 – Fabric #AASCF
 – Leather #AASCL

Arm Chair

- 25"w x 17 1/2"d x 38"h
 – Wood #AAACW
 – Fabric #AAACF
 – Leather #AAACL

Desk Chair

- 25 1/2"w x 17 1/2"d x 38"h



Angola Chair

Side Chair

- 19"w x 16 1/2"d x 40"h
 – Wood #ALSCW

Arm Chair

- 25"w x 16 1/2"d x 40"h
 – Wood #ALACW

Desk Chair

- 25"w x 16 1/2"d x 40"h

*Not available in two tone finish



Arabella Chair

Side Chair

- 18 3/4"w x 17"d x 32 1/4"h
 – Wood #ARSCW
 – Fabric #ARSCF
 – Leather #ARSCL



Asher Chair

Side Chair

- 19 1/4"w x 17 1/4"d x 41"h
 – Wood #ASSCW
 – Fabric #ASSCF
 – Leather #ASSCL

Arm Chair

- 23 1/2"w x 17 1/4"d x 41"h
 – Wood #ASACW
 – Fabric #ASACF
 – Leather #ASACL



Banks Chair

Side Chair

- 19 1/2"w x 21"d x 38 3/4"h
 – Fabric #BSSCF
 – Leather #BSSCL

Arm Chair

- 27"w x 21"d x 38 3/4"h
 – Fabric #BSACF
 – Leather #BSACL

Banks Desk Chair

Arm Desk Chair

- 27"w x 21"d x 38 3/4"h
 – Fabric #BSACFCGL
 – Leather #BSACLGL



Baily Chair

Side Chair

- 18"w x 20 1/2"d x 34 1/2"h
 – Wood #BYSCW
 Fabric, leather and arm chair not available

*Desk chair not available.



Bartlett Chair

Side Chair

- 19 1/4"w x 17"d x 38 1/4"h
 – Wood #BRSCW
 – Fabric #BRSCF
 – Leather #BRSL

Arm Chair

- 24"w x 17"d x 38 1/4"h
 – Wood #BRACW
 – Fabric #BRACF
 – Leather #BRACL



Beacon Hill Chair

Side Chair

18 1/2" w x 16 1/2" d x 38" h

- Fabric #BHSC
- Leather #BHSCSCL

Arm Chair

25 1/2" w x 16 1/2" d x 38" h

- Fabric #BHAC
- Leather #BHACLSCL

Add to item number the following trim options:

- (#F) French Natural
 - (#P) Pewter Nickel
 - (#Z) Z Finish
- (standard if not specified)

Beacon Hill Slat Chair

Side Chair

19" w x 16 1/2" d x 37 1/2" h

- Wood #BHSSC
- Fabric #BHSSCF
- Leather #BHSSCL

Arm Chair

19" w x 16 1/2" d x 37 1/2" h

- Wood #BHSAC
- Fabric #BHSACF
- Leather #BHSACLSCL

Bridgeport Chair

Side Chair

17" w x 16 1/2" d x 37 1/2" h

- Wood #BTSCW

*Not available in two tone finish

Caspian Chair

Side Chair

19" w x 17" d x 39" h

- Fabric #CPSCF
- Leather #CPSCL

Arm Chair

24" w x 17" d x 39" h

- Fabric #CPACF
- Leather #CPACLSCL

*Not available in stationary bar chairs, only swivel



Celina Chair

Side Chair

19" w x 17" d x 39" h

- Fabric #CLSCF
- Leather #CLSCL

Arm Chair

20" w x 17" d x 39" h

- Fabric #CLACF
- Leather #CLACLSCL

*Not available in stationary bar chairs, only swivel

Classic Chair

Side Chair

18" w x 17 3/4" d x 42" h

- Wood #CCSCW
- Fabric #CCSCF
- Leather #CCSCL

Arm Chair

25 1/2" w x 17 3/4" d x 42" h

- Wood #CCACW
- Fabric #CCACF
- Leather #CCACLSCL

Desk Chair

25 1/2" w x 17 3/4" d x 42" h

Cohen Chair

Side Chair

19 1/2" w x 21" d x 38 3/4" h

- Fabric #CNSCF
- Leather #CNSCL

Arm Chair

27" w x 21" d x 38 3/4" h

- Fabric #CNACF
- Leather #CNACLSCL

Conner Chair

Side Chair

19" w x 17" d x 41" h

- Wood #CRSCW
- Fabric #CRSCF
- Leather #CRSCL

Arm Chair

25" w x 17" d x 41" h

- Wood #CRACW
- Fabric #CRACF
- Leather #CRACLSCL

CHAIRS



Durham Chair

Side Chair

- 17 3/8" w x 17" d x 37 1/4" h
 – Wood #DMSCW
 – Fabric #DMSCF
 – Leather #DMSCL

Arm Chair

- 23 3/8" w x 17" d x 37 1/4" h
 – Wood #DMACW
 – Fabric #DMACF
 – Leather #DMACL



Edmonton Chair

Side Chair

- 18" w x 17" d x 38" h
 – Wood #ENSCW

Arm Chair

- 22 1/2" w x 17" d x 38" h
 – Wood #ENACW

*Not available in two tone finish



Elara Chair

Side Chair

- 18 1/2" w x 16 3/4" d x 38" h
 – Fabric #EASC
 – Leather #EASCL



Ellington Chair

Side Chair

- 18 1/2" w x 17" d x 41" h
 – Wood #ELSCW
 – Fabric #ELSCF
 – Leather #ELSCL

Arm Chair

- 26 1/2" w x 17" d x 41" h
 – Wood #ELACW
 – Fabric #ELACF
 – Leather #ELACL



Gibson Chair

Side Chair

- 19" w x 17 1/2" d x 38" h
 – Wood #GBSCW
 – Fabric #GBSCF
 – Leather #GBSCL

Arm Chair

- 22" w x 17 1/2" d x 38" h
 – Wood #GBACW
 – Fabric #GBACF
 – Leather #GBACL



Hatfield Chair

Side Chair

- 18 1/2" w x 16 1/2" d x 37 1/2" h
 – Wood #HASCW
 – Fabric #HASCF
 – Leather #HASCL

Arm Chair

- 25" w x 16 1/2" d x 37 1/2" h
 – Wood #HAACW
 – Fabric #HAACF
 – Leather #HAACL



Hayworth Chair

Side Chair

- 18" w x 18" d x 43" h
 – Wood #HHSCW
 – Fabric #HHSCF
 – Leather #HHSCL

Arm Chair

- 26" w x 18" d x 43" h
 – Wood #HHACW
 – Fabric #HHACF
 – Leather #HHACL



Hayworth Highback Chair

Side Chair

- 19" w x 18" d x 49" h
 – Wood #HHHSCW
 – Fabric #HHHSCF
 – Leather #HHHSCL

Arm Chair

- 26" w x 18" d x 49" h
 – Wood #HHHACW
 – Fabric #HHHACF
 – Leather #HHHACL

CHAIRS



Henning Chair

Side Chair

- 18 1/2" w x 17 1/2" d x 32" h
 – Wood #HGSCW
 – Fabric #HGSCF
 – Leather #HGSCS



Infinity Chair

Side Chair

- 16 1/2" w x 16" d x 33 3/4" h
 – Wood #IYSCW
 – Fabric #IYSCF
 – Leather #IYSCL



Jameson Chair

Side Chair

- 17" w x 16 3/4" d x 39 1/2" h
 – Wood Seat #JNSCW
 – Fabric Seat #JNSCF
 – Leather Seat #JNSCL



"STOCK
ITEMS
READY FOR
IMMEDIATE
SHIPPING"

Kendall Chair

Side Chair

- 19" w x 18 5/8" d x 42" h
 – Wood #KLSCW
 – Fabric #KLSCF
 – Leather #KLSCL

Arm Chair

- 25" w x 18 5/8" d x 42" h
 – Wood #KLACW
 – Fabric #KLACF
 – Leather #KLACL



"STOCK
ITEMS
READY FOR
IMMEDIATE
SHIPPING"

Kennebec Chair

Side Chair

- 19 1/2" w x 19" d x 42" h
 – Wood #KCSCW
 – Fabric #KCSCF
 – Leather #KCSCS

Arm Chair

- 25" w x 19" d x 42" h
 – Wood #KCACW
 – Fabric #KCACF
 – Leather #KCACL

Desk Chair

- 25" w x 19" d x 42" h



Livonia Channel Back Desk Chair

- 25" w x 20" d x 37" h
 – Fabric #LVACCF
 – Leather #LVACCL



Livonia Desk Chair

- 25" w x 20" d x 37" h
 – Fabric #LVACF
 – Leather #LVACL



Madrid Chair

Side Chair

- 19 1/2" w x 18" d x 35" h
 – Fabric #MDSCF
 – Leather #MDSCS

*Not available as swivel bar chairs

* Not available as desk chair



Optional Base:

Caswell Gas Lift Base (#CGL)

*see next page for more chair options.



Morgan Chair

Side Chair

- 19 1/4" w x 17" d x 34" h
- Wood #MNSCW
- Fabric #MNSCF
- Leather #MNSCL

Arm Chair

- 24 1/2" w x 17" d x 34" h
- Wood #MNACW
- Fabric #MNACF
- Leather #MNACL



Old Mission Chair

Side Chair

- 18" w x 17" d x 38" h
- Wood #OMSCW
- Fabric #OMSCF
- Leather #OMSCL

Arm Chair

- 25" w x 18" d x 38" h
- Wood #OMACW
- Fabric #OMACF
- Leather #OMACL



"STOCK ITEMS READY FOR IMMEDIATE SHIPPING"

Palmer Chair

Side Chair

- 18 1/2" w x 16 1/2" d x 37 1/2" h
- Wood #PRSCW
- Fabric #PRSCF
- Leather #PRSCL

Arm Chair

- 25" w x 16 1/2" d x 37 1/2" h
- Wood #PRACW
- Fabric #PRACF
- Leather #PRACL



"STOCK ITEMS READY FOR IMMEDIATE SHIPPING"

Richfield Chair

Side Chair

- 19 1/2" w x 17 1/2" d x 41" h
- Wood #NC-9036SCW
- Fabric #NC-9036SCF
- Leather #NC-9036SCL

Arm Chair

- 26" w x 17 1/2" d x 41" h
- Wood #NC-9036ACW
- Fabric #NC-9036ACF
- Leather #NC-9036ACL



Sedona Chair

Side Chair

- 19" w x 17" d x 38" h
- Wood #SASCW
- Fabric #SASCF
- Leather #SASCL

Arm Chair

- 25" w x 18" d x 41" h
- Wood #SAACW
- Fabric #SAACF
- Leather #SAACL

Desk Chair

- 25" w x 18" d x 41" h



"STOCK ITEMS READY FOR IMMEDIATE SHIPPING"

Sebring Chair

Side Chair

- 18 1/2" w x 16 1/2" d x 37 1/2" h
- Wood #SGSCW
- Fabric #SGSCF
- Leather #SGSCL

Arm Chair

- 25" w x 16 1/2" d x 37 1/2" h
- Wood #SGACW
- Fabric #SGACF
- Leather #SGACL



Simplicity Chair

Side Chair (with Inlays)

- 19" w x 17.5" d x 42" h
- Wood #51-9065SCW
- Fabric #51-9065SCF
- Leather #51-9065SCL

Side Chair (without Inlays)

- 19" w x 17.5" d x 42" h
- Wood #51-9065SCWNI
- Fabric #51-9065SCFNI
- Leather #51-9065SCLNI



Tarra Chair

Side Chair

- 18 1/2" w x 20" d x 31" h
- Fabric #TASCF
- Leather #TASCL

*Arm chair not available



Xander Chair

Side Chair

- 19" w x 17 1/4" d x 42 1/4" h
- Wood #XRSCW
- Fabric #XRSCF
- Leather #XRSCL

Arm Chair

- 25 3/4" w x 17 1/4" d x 42 1/4" h
- Wood #XRACW
- Fabric #XRACF
- Leather #XRACL

Create Your Own Desk Chair

Caswell optional desk chair base, available on all chairs unless otherwise noted.



Livonia Desk Chair

25" w x 20" d x 37" h

- Fabric #LVACF
- Leather #LVACL

Caswell Gas Lift Base #CGL

- When ordering, add desk chair base style # to end of arm chair # for correct item code
- Only available on arm chairs
- Available on all arm chairs



Shown with optional Caswell Base

Standard Livonia base pictured below



BARSTOOLS



Americana Bar Chair

Seat Height 24" Stationary

- 19" w x 17 1/2" d x 42" h
- Wood-#AASCW24B
- Leather-#AASCW24BL
- Fabric-#AASCW24BF

Seat Height 30" Stationary

- 19" w x 17 1/2" d x 48" h
- Wood-#AASCW30B
- Leather-#AASCW30BL
- Fabric-#AASCW30BF



Americana Swivel Bar Chair

Seat Height 24" Swivel

- 19" w x 17 1/2" d x 42" h
- Wood-#AASCW24WB
- Leather-#AASCW24WBL
- Fabric-#AASCW24WBF

Seat Height 30" Swivel

- 19" w x 17 1/2" d x 48" h
- Wood-#AASCW30WB
- Leather-#AASCW30WBL
- Fabric-#AASCW30WBF



Banks Bar Chair

Seat Height 24" Stationary

- 19 1/2" w x 21" d x 39 1/2" h
- Fabric #BSSCF24B
- Leather #BSSCL24B

Seat Height 24" Swivel

- 19 1/2" w x 21" d x 39 1/2" h
- Fabric #BSSCF24WB
- Leather #BSSCL24WB

Seat Height 30" Stationary

- 19 1/2" w x 21" d x 45 1/2" h
- Fabric #BSSCF30B
- Leather #BSSCL30B

Seat Height 30" Swivel

- 19 1/2" w x 21" d x 45 1/2" h
- Fabric #BSSCF30WB
- Leather #BSSCL30WB



Bartlett Bar Chair

Seat Height 24" Stationary

- 20 1/4" w x 17" d x 44 1/4" h
- Wood #BRSCW24B
- Fabric #BRSCF24B
- Leather #BRSL24B

Seat Height 24" Swivel

- 20 1/4" w x 17" d x 44 1/4" h
- Wood #BRSCW24WB
- Fabric #BRSCF24WB
- Leather #BRSL24WB

Seat Height 30" Stationary

- 21 1/4" w x 17" d x 50 1/4" h
- Wood #BRSCW30B
- Fabric #BRSCF30B
- Leather #BRSL30B

Seat Height 30" Swivel

- 21 1/4" w x 17" d x 50 1/4" h
- Wood #BRSCW30WB
- Fabric #BRSCF30WB
- Leather #BRSL30WB



Beacon Hill Upholstered Bar Chair

Seat Height 24" Stationary

- 18 1/2" w x 16 1/2" d x 44" h
- Fabric #BHSCF24B
- Leather #BHSL24B

Seat Height 24" Swivel

- Fabric #BHSCF24WB
- Leather #BHSL24WB

Seat Height 30" Stationary

- 18 1/2" w x 16 1/2" d x 50" h
- Fabric #BHSCF30B
- Leather #BHSL30B

Seat Height 30" Swivel

- Fabric #BHSCF30WB
- Leather #BHSL30WB



#F



#P



#Z

Add to item number the following trim options:

- (#F) French Natural
 - (#P) Pewter Nickel
 - (#Z) Z Finish
- (standard if not specified)

BARSTOOLS



Cape Cod Bar Chair w/ Back

Seat Height 24" Stationary

- 25" w x 18" d x 40" h
- Wood #CDBSW
- Leather #CDBSL
- Fabric #CDBSF

Seat Height 30" Stationary

- 25" w x 18" d x 46" h
- Wood #CD30BSL
- Leather #CD30BSL
- Fabric #CD30BSF

- NO KICKPLATE AVAILABLE -



Cape Cod Swivel Bar Chair w/ Back

Seat Height 24" Swivel (Seat only)

- 25" w x 18" d x 40" h
- Wood #CD24BSWW
- Fabric #CD24BSWF
- Leather #CD24BSWL

Seat Height 30" Swivel (Seat only)

- 25" w x 18" d x 46" h
- Wood #CD30BSWW
- Fabric #CD30BSWF
- Leather #CD30BSWL

- NO KICKPLATE AVAILABLE -



Open Cape Cod Swivel Bar Chair

Seat Height 24" Swivel (Seat only)

- 25" w x 18" d x 40" h
- Wood #OD24BSWW
- Fabric #OD24BSWF
- Leather #OD24BSWL

Seat Height 30" Swivel (Seat only)

- 25" w x 18" d x 46" h
- Wood #OD30BSWW
- Fabric #OD30BSWF
- Leather #OD30BSWL

- NO KICKPLATE AVAILABLE -



Claremont Bar Chair

Seat Height 24" Stationary

- 18" w x 16" d x 24" h
- Leather #CT24WL
- Fabric #CT24WF

Seat Height 30" Stationary

- 18" w x 16" d x 30" h
- Leather #CT30WL
- Fabric #CT30WF



Classic Bar Chair

Seat Height 24" Stationary

- 17 3/4" w x 16 1/2" d x 42 1/2" h
- Wood #CCSCW24B
- Leather #CCSCW24BL
- Fabric #CCSCW24BF

Seat Height 30" Stationary

- 17 3/4" w x 16 1/2" d x 48 1/2" h
- Wood #CCSCW30B
- Leather #CCSCW30BL
- Fabric #CCSCW30BF



Classic Swivel Bar Chair

Seat Height 24" Swivel

- 17 3/4" w x 16 1/2" d x 42 1/2" h
- Wood #CCSCW24WB
- Leather #CCSCW24WBL
- Fabric #CCSCW24WBF

Seat Height 30" Swivel

- 17 3/4" w x 16 1/2" d x 48 1/2" h
- Wood #CCSCW30WB
- Leather #CCSCW30WBL
- Fabric #CCSCW30WBF

BARSTOOLS

Cohen Bar Chair



Seat Height 24" Stationary

19 1/2" w x 21" d x 38 1/2" h
 – Fabric #CNSCF24B
 – Leather #CNSCL24B

Seat Height 24" Swivel

19 1/2" w x 21" d x 38 1/2" h
 – Fabric #CNSCF24WB
 – Leather #CNSCL24WB

Seat Height 30" Stationary

19 1/2" w x 21" d x 44 1/2" h
 – Fabric #CNSCF30B
 – Leather #CNSCL30B

Seat Height 30" Swivel

19 1/2" w x 21" d x 44 1/2" h
 – Fabric #CNSCF30WB
 19 1/2" w x 21" d x 38 3/4" h
 – Leather #CNSCL30WB

Conner Bar Chair



Seat Height 24" Stationary

19" w x 17" d x 42" h
 – Wood #CRSCW24B
 – Fabric #CRSCF24B
 – Leather #CRSCL24B

Seat Height 24" Swivel

– Wood #CRSCW24WB
 – Fabric #CRSCF24WB
 – Leather #CRSCL24WB

Seat Height 30" Stationary

19" w x 17" d x 48" h
 – Wood #CRSCW30B
 – Fabric #CRSCF30WB
 – Leather #CRSCL30WB

Seat Height 30" Swivel

– Wood #CRSCW24WB
 – Fabric #CRSCF30WB
 – Leather #CRSCL30WB

Edan Bar Chair



Seat Height 24" Stationary

17" w x 16" d x 34" h
 – Leather-#EN24WL
 – Fabric-#EN24WF

Seat Height 30" Stationary

17" w x 16" d x 40" h
 – Leather-#EN30WL
 – Fabric-#EN30WF

Elara Bar Chair



Seat Height 24" Stationary

18 1/2 x 16 3/4 x 44
 – Leather-#EASCW24BL
 – Fabric-#EASCW24BF

Seat Height 30" Stationary

18 1/2 x 16 3/4 x 50
 – Leather-#EASCW30BL
 – Fabric-#EASCW30BF

*Only available in stationary,
 not swivel

Hatfield Bar Chair



Seat Height 24" Stationary

18 1/2" w x 17" d x 42" h
 – Wood-#HASCW24B
 – Leather-#HASCW24BL
 – Fabric-#HASCW24BFL

Seat Height 30" Stationary

18 1/2" w x 17" d x 48" h
 – Wood-#HASCW30B
 – Leather-#HASCW30BL
 – Fabric-#HASCW30BF

Seat Height 24" Swivel

– Wood-#HASCW24WB
 – Leather-#HASCW24WBL
 – Fabric-#HASCW24WBF

Seat Height 30" Swivel

– Wood-#HASCW30WB
 – Leather-#HASCW30WBL
 – Fabric-#HASCW30WBF

(Swivel photo not available)

BARSTOOLS



Hayworth Bar Chair

Seat Height 24" Stationary

- 18" w x 16 3/4" d x 43 1/2" h
- Wood-#HHSCW24B
- Leather-#HHSCW24BL
- Fabric-#HHSCW24BF

Seat Height 30" Stationary

- 18" w x 16 3/4" d x 49 1/2" h
- Wood-#HHSCW30B
- Leather-#HHSCW30BL
- Fabric-#HHSCW30BF



Infinity Bar Chair

Seat Height 24" Stationary

- 17" w x 16" d x 37 1/2" h
- Wood-#IYSCW24B
- Leather-#IYSCW24BL
- Fabric-#IYSCW24BF

Seat Height 30" Stationary

- 17" w x 16" d x 43 1/2" h
- Wood-#IYSCW30B
- Leather-#IYSCW30BL
- Fabric-#IYSCW30BF



Kendall Bar Chair

Seat Height 24" Stationary

- 19" w x 18 5/8" d x 44" h
- Wood #KLSCW24B
- Fabric #KLSCF24B
- Leather #KLSCW24BL

Seat Height 24" Swivel

- Wood #KLSCW24WB
- Fabric #KLSCF24WB
- Leather #KLSCW24WBL

Seat Height 30" Stationary

- 19" w x 18 5/8" d x 50" h
- Wood #KLSCW30B
- Fabric #KLSCF30B
- Leather #KLSCW30BL

Seat Height 30" Swivel

- Wood #KLSCW30WB
- Fabric #KLSCF30WB
- Leather #KLSCW30WBL



Kennebec Bar Chair

Seat Height 24" Stationary

- 19 1/2" w x 19" d x 43" h
- Wood-#KCSCW24B
- Leather-#KCSCW24BL
- Fabric-#KCSCW24BF

Seat Height 30" Stationary

- 19 1/2" w x 19" d x 49" h
- Wood-#KCSCW30B
- Leather-#KCSCW30BL
- Fabric-#KCSCW30BF



Livonia Swivel Bar Chair

Seat Height 24" Swivel

- 24" w x 17" d x 41" h
- Leather-#LVACFL24B
- Fabric-#LVACF24BF

Seat Height 30" Swivel

- 24" w x 17" d x 47" h
- Leather-#LVACFL30B
- Fabric-#LVACF30BF

- NO KICKPLATE AVAILABLE -



Madrid Bar Chair

Seat Height 24" Stationary

- 24"-19 1/2" w x 18" d x 41" h
- Leather-#MDSCF24B
- Fabric-#MDSCL24B

Seat Height 30" Stationary

- 30"-19 1/2" w x 18" d x 47" h
- Leather-#MDSCF30B
- Fabric-#MDSCL30B

BARSTOOLS

Morgan Bar Chair



Seat Height 24" Stationary

- 19 1/4" w x 17" d x 40" h
- Wood #MNSCW24B
- Fabric #MNSCF24B
- Leather #MNSCL24B

Seat Height 24" Swivel

- Wood #MNSCW24WB
- Fabric #MNSCF24WB
- Leather #MNSCL24WB

Seat Height 30" Stationary

- 19 1/4" w x 17" d x 46" h
- Wood #MNSCW30B
- Fabric #MNSCF30B
- Leather #MNSCL30B

Seat Height 30" Swivel

- Wood #MNSCW30WB
- Fabric #MNSCF30WB
- Leather #MNSCL30WB

Old Mission Bar Chair



Seat Height 24" Stationary

- 18 1/2" w x 17 1/2" d x 42 1/2" h
- Wood-#OMSCW24B
- Leather-#OMSCW24BL
- Fabric-#OMSCW24BF

Seat Height 30" Stationary

- 18 1/2" w x 17 1/2" d x 48 1/2" h
- Wood-#OMSCW30B
- Leather-#OMSCW30BL
- Fabric-#OMSCW30BF

Old Mission Swivel Bar Chair



Seat Height 24" Swivel

- 18 1/2" w x 17 1/2" d x 42 1/2" h
- Wood-#OMSCW24WB
- Leather-#OMSCW24WBL
- Fabric-#OMSCW24WBF

Seat Height 30" Swivel

- 18 1/2" w x 17 1/2" d x 48 1/2" h
- Wood-#OMSCW30WB
- Leather-#OMSCW30WBL
- Fabric-#OMSCW30WBF

Richfield Bar Chair



Seat Height 24" Stationary

- 19" w x 18 5/8" d x 43 1/2" h
- Wood #NC-9036SCW24B
- Fabric #NC-9036SCF24B
- Leather #NC-9036SCL24B

Seat Height 24" Swivel

- 19" w x 18 5/8" d x 43 1/2" h
- Wood #NC-9036SCW24WB
- Fabric #NC-9036SCF24WB
- Leather #NC-9036SCL24WB

Seat Height 30" Stationary

- 19" w x 18 5/8" d x 49 1/2" h
- Wood #NC-9036SCW30B
- Fabric #NC-9036SCF30B
- Leather #NC-9036SCL30B

Seat Height 30" Swivel

- 19" w x 18 5/8" d x 49 1/2" h
- Wood #NC-9036SCW30WB
- Fabric #NC-9036SCF30WB
- Leather #NC-9036SCL30WB

Saddle Swivel Bar Stool



Seat Height 24" Swivel

- 22" w x 13 1/2" d x 24" h
- Wood #SD24WW

Seat Height 30" Swivel

- 22" w x 13 1/2" d x 30" h
- Wood #SD30WW

- NO KICKPLATE AVAILABLE -

Saddle Bar Stool



Seat Height 24" Stationary

- 22" w x 13 1/2" d x 24" h
- Wood #SD24TW

Seat Height 30" Stationary

- 22" w x 13 1/2" d x 30" h
- Wood #SD30TW

- NO KICKPLATE AVAILABLE -

BARSTOOLS

Sagamore Swivel Bar Chair



Seat Height 24" Swivel

- 19" w x 19" d x 24" h
- Wood-#SE24WW
- Leather-#SE24WWL
- Fabric-#SE24WWF

Seat Height 30" Swivel

- 19" w x 19" d x 30" h
- Wood-#SE30WW
- Leather-#SE30WWL
- Fabric-#SE30WWF

- STANDARD WITH KICKPLATE -

CUSHION & TRIM OPTIONS



Box Cushion (#BC)
French Natural Brass
Trim (#FN)



Nickel trim is standard

Sagamore Swivel
Bar Chair shown
w/ **Optional Box
Cushion (#BC)**

Simplicity Bar Chair



Seat Height 24" Stationary

- 19" w x 24" d x 43 1/4" h
- Wood #51-9065SCW24B
- Fabric #51-9065SCF24B
- Leather #51-9065SCL24B

Seat Height 24" Swivel

- 19" w x 24" d x 43 1/4" h
- Wood #51-9065SCW24WB
- Fabric #51-9065SCF24WB
- Leather #51-9065SCL24WB

Seat Height 30" Stationary

- 19" w x 24" d x 49 1/4" h
- Wood #51-9065SCW30B
- Fabric #51-9065SCF30B
- Leather #51-9065SCL30B

Seat Height 30" Swivel

- 19" w x 24" d x 49 1/4" h
- Wood #51-9065SCW30WB
- Fabric #51-9065SCF30WB
- Leather #51-9065SCL30WB



Sedona Bar Chair

Seat Height 24" Stationary

- 19" w x 17" d x 42" h
- Wood-#SASCW24B
- Leather-#SASCW24BL
- Fabric-#SASCW24BF

Seat Height 30" Stationary

- 19" w x 17" d x 48" h
- Wood-#SASCW30B
- Leather-#SASCW30BL
- Fabric-#SASCW30BF



Protective Stretcher Cover (#PC)

Protective cover available in Black and Brushed Stainless. Covers are available on bar chairs only.

CHAIR DIMENSIONS

Style	Side Chair Seating Area W x D	Arm Chair Seating Area W x D	Overall Arm Width	Arm Height	Seat Height	Back Height From Seat	Back Height From Floor
Americana	19 x 17 ½	19 x 17 ½	25	7 ¾	18	20	38
24" Barstool	19 x 17 ½	-	-	-	24	18	42
30" Barstool	19 x 17 ½	-	-	-	30	18	48
Angola	18 x 16 ½	20 x 16 ½	25	8	17 ½	23	40 ½
24" Barstool	18 x 16 ½	-	-	-	24	22 ½	46 ½
30" Barstool	18 x 16 ½	-	-	-	30	22 ½	52 ½
Arabella	18 ¾ x 17	-	-	-	18	18 ½	35 ¼
24" Barstool	18 ¾ x 17	-	-	-	24	18 ½	41 ½
30" Barstool	18 ¾ x 17	-	-	-	30	18 ½	48 ½
Asher	19 ¼ x 17 ¼	19 ¼ x 17 ¼	23 ½	8	18	24 ½	41
24" Barstool	19 ¼ x 17 ¼	-	-	-	24	24 ½	47
30" Barstool	19 ¼ x 17 ¼	-	-	-	30	24 ½	53
Ashton 36" Bench	17 X 36	-	-	-	19	-	-
Ashton 48" Bench	17 X 48	-	-	-	19	-	-
Ashton 60" Bench	17 X 60	-	-	-	19	-	-
Ashton 72" Bench	17 X 72	-	-	-	19	-	-
Baily	18 X 20 ½	-	-	-	18	16 ½	34 ½
Banks	19 ½ X 21	19 ½ X 21	27	7 ¾	18	20 ¾	38 ¾
24" Barstool	19 ½ X 21	19 ½ X 21	-	-	24	15 ½	39 ½
30" Barstool	19 ½ X 21	19 ½ X 21	-	-	30	15 ½	45 ½
Bartlett	19 ¼ x 17	19 ¼ x 17	24	8 ¼	17 ½	22 ½	38 ¼
24" Barstool	20 ¼ x 17	-	-	-	24	20 ¼	44 ¼
30" Barstool	21 ¼ x 17	-	-	-	30	20 ¼	50 ¼
Beacon Hill Slat	19 x 16 ½	19 x 16 ½	24	7 ½	18	20 ½	37 ½
24" Barstool	19 x 16 ½	19 x 16 ½	24	7 ½	24	20 ½	43 ½
30" Barstool	19 x 16 ½	19 x 16 ½	24	7 ½	30	20 ½	49 ½
Beacon Hill	18 ½ x 16 ½	18 ½ x 16 ½	25 ½	7 ½	18	20 ½	38
24" Barstool	18 ½ x 16 ½	18 ½ x 16 ½	25 ½	7 ½	24	20 ½	44
30" Barstool	18 ½ x 16 ½	18 ½ x 16 ½	25 ½	7 ½	30	20 ½	50
Bridgeport	17 ¼ x 16	-	-	-	17 ¼	22 ½	38
24" Capecod with back	16 ½ x 16 ½	-	-	-	24	16	40
30" Capecod with back	16 ½ x 16 ½	-	-	-	30	16	46
Caspian	19 x 17	20 x 17	24	25	19	20	39
Claremont	-	-	-	-	-	-	-
24" Barstool	14 x 18	-	-	-	24	-	-
30" Barstool	14 x 18	-	-	-	30	-	-

Style	Side Chair Seating Area W x D	Arm Chair Seating Area W x D	Overall Arm Width	Arm Height	Seat Height	Back Height From Seat	Back Height From Floor
Classic	17 ¾ x 16 ½	17 ¾ x 16 ½	25 ½	7 ¾	18	24	42
24" Barstool	17 ¾ x 16 ½	-	-	-	24	18 ½	42 ½
30" Barstool	17 ¾ x 16 ½	-	-	-	30	18 ½	48 ½
Cohen	19 ½ X 21	19 ½ X 21	27	7 ¾	18	20 ¾	38 ¾
24" Barstool	19 ½ X 21	-	-	-	24	14 ½	38 ½
30" Barstool	19 ½ X 21	-	-	-	30	14 ½	44 ½
Conner	19 x 17	19 x 17	25	7 ¾	18	23	41
24" Barstool	19 x 17	-	-	-	24	18	42
30" Barstool	19 x 17	-	-	-	30	18	48
Durham	17 3/8 x 17	17 3/8 x 17	23 ½	7 ¾	17 ½	21 ¼	37 ¼
24" Barstool	17 3/8 x 17	-	-	-	24	19 ¼	43 ¼
30" Barstool	17 3/8 x 17	-	-	-	30	19 ¼	49 ¼
Edmonton	17 ¼ x 17 ½	18 ½ x 17 ½	25	8	18	21 ½	39 ½
24" Barstool	18 ¼ x 17 ½	-	-	-	24	21 ½	45 ½
30" Barstool	19 ¼ x 17 ½	-	-	-	30	21 ½	51 ½
Edan	-	-	-	-	-	-	-
24" Barstool	16 ¼ x 16	-	-	-	24	10	34
30" Barstool	16 ¼ x 16	-	-	-	30	10	40
Elara	18 ½ x 16 ¾	-	-	-	18	20	38
24" Barstool	18 ½ x 16 ¾	-	-	-	24	20	44
30" Barstool	18 ½ x 16 ¾	-	-	-	30	20	50
Ellington	18 ½ x 17	18 ½ x 17	26 ½	7 ¾	17 ½	23 ½	41
24" Barstool	18 ½ x 17	-	-	-	24	20	44
30" Barstool	18 ½ x 17	-	-	-	30	20	50
Gibson	19 x 17 ½	19 x 17 ½	22	7 ½	17 ½	20 ½	38
24" Barstool	20 x 17 ½	-	-	-	24	20	44
30" Barstool	21 x 17 ½	-	-	-	30	20	50
Hatfield	18 ½ x 17	18 ½ x 17	23 ½	7 ¾	17 ½	20	37 ½
24" Barstool	18 ½ x 17	-	-	-	24	18	42
30" Barstool	18 ½ x 17	-	-	-	30	18	48
Hayworth	18 x 16 ¾	18 x 16 ¾	25	7 ¾	18	25 ½	43 ¼
24" Barstool	18 x 16 ¾	-	-	-	24	19 ½	43 ½
30" Barstool	18 x 16 ¾	-	-	-	30	19 ½	49 ½
Hayworth Highback	18 x 16 ¾	18 x 16 ¾	25	7 ¾	18	32 ¾	49
Infinity	17 ¾ x 15 ¾	-	-	-	17 ½	16	33 ½
24" Barstool	17 x 16	-	-	-	24	13 ½	37 ½
30" Barstool	17 x 16	-	-	-	30	13 ½	43 ½

Style	Side Chair Seating Area W x D	Arm Chair Seating Area W x D	Overall Arm Width	Arm Height	Seat Height	Back Height From Seat	Back Height From Floor
Jameson	17 x 16 ¾	-	-	-	17 ½	23	39 ½
Kendall	19 x 18 5/8	19 x 18 5/8	25	7 ¾	18	24 ½	42
24" Barstool	19 x 18 5/8	-	-	-	24	24 ½	44
30" Barstool	19 x 18 5/8	-	-	-	30	24 ½	50
Kennebec	18 ¾ x 18 ½	18 ¾ x 18 ½	25	7 ¾	18	24	42
24" Barstool	18 ¾ x 18 ½	-	-	-	24	24	48
30" Barstool	18 ¾ x 18 ½	-	-	-	30	24	54
Livonia	-	20 ½ x 20 ½	25 ½	25 ½ – 30 ½	19 – 24	19	36 – 41
24" Barstool	-	19 ½ x 17	24 ¼	32 ¼	24	18	42
30" Barstool	-	19 ½ x 17	24 ¼	38 ¼	30	18	48
Madrid	19 ½ x 18	-	-	-	18	17 ½	35
Morgan	19 ¼ x 17	19 ¼ x 17	24 ½	7 ¼	18	16	34
24" Barstool	19 ¼ x 17	-	-	-	24	16	40
30" Barstool	19 ¼ x 17	-	-	-	30	16	46
Old Mission	18 ½ x 17 ½	18 ½ x 17 ½	25 ¼	25 ¾	17 ¼	21 ½	38 ½
24" Barstool	18 ½ x 17 ½	-	-	-	24	18 ½	42 ½
30" Barstool	18 ½ x 17 ½	-	-	-	30	18	48 ½
24" Open Capecod (without back)	16 ½ x 16 ½	-	-	-	24	16	40
30" Open Capecod (without back)	16 ½ x 16 ½	-	-	-	30	16	46
Palmer	18 ½ X 16 ½	18 ½ X 16 ½	25	7 ¾	17 ½	20	37 ½
Richfield	19 ½ x 17 ½	19 ½ x 17 ½	26	7 ¾	18	23	41
24" Barstool	19 X 18 5/8	-	-	-	24	19 ½	43 ½
30" Barstool	19 X 18 5/8	-	-	-	30	19 ½	49 ½
Saddle Bar Chair	-	-	-	-	-	-	-
24" Barstool	22 x 13 ½	-	-	-	24	-	-
30" Barstool	22 x 13 ½	-	-	-	30	-	-
Sagamore 24" Swivel Barstool	16 ½ x 16 ½	-	-	-	24	-	-
Sagamore 30" Swivel Barstool	16 ½ x 16 ½	-	-	-	30	-	-
Sebring	18 ½ x 16 ½	18 ½ x 16 ½	25	7 ¾	17 ½	20	37 ½
Sedona	19 ¼ x 17	19 ¼ x 17	25	7 ¾	17 ½	20 ½	38
24" Barstool	19 ¼ x 17	-	-	-	24	18	42
30" Barstool	19 ¼ x 17	-	-	-	30	18	48

Style	Side Chair Seating Area W x D	Arm Chair Seating Area W x D	Overall Arm Width	Arm Height	Seat Height	Back Height From Seat	Back Height From Floor
Simplicity	19 x 17.5	19 x 17.5	25 ¼	7 ¾	18	24 ½	42
24" Barstool	19 X 24	-	-	-	24	19 ¼	43 ¼
30" Barstool	19 X 24	-	-	-	30	19 ¼	49 ¼
Xander	19 ¼ x 17 ¼	19 ¼ x 17 ¼	25 ¾	7 ½	18	24 ¼	42 ¼
24" Barstool	20 ¼ x 17 ¼	-	-	-	24	24 ¼	48 ¼
30" Barstool	21 ¼ x 17 ¼	-	-	-	30	24 ¼	54 ¼



BENCHES



Ashton Bench

17" d x 19" h
 Fabric, 36" w #ANBEN36F
 Fabric, 48" w #ANBEN48F
 Fabric, 60" w #ANBEN60F
 Fabric, 72" w #ANBEN72F
 Leather, 36" w #ANBEN36L
 Leather, 48" w #ANBEN48L
 Leather, 60" w #ANBEN60L
 Leather, 72" w #ANBEN72L

Choice of nail finish,
 specify when ordering.



Add to item number to the following trim options:

- (#F) French Natural
- (#P) Pewter Nickel
- (#Z) Z Finish

Caspian Expandable Bench

#CPEXB
 48" - 96" w x 13" d x 18" h

Caspian Bench (not shown)

13" d x 18" h
 36" w #CPBEN36
 48" w #CPBEN48
 60" w #CPBEN60
 72" w #CPBEN72



Features Plank Style Top



Elliot Bench

#ETBEN36 36"
 #ETBEN48 48"
 #ETBEN60 60"
 #ETBEN72 72"

Elliot Expandable Bench

#ETEXB

Fulton Bench

#FNBEN36 36"
 #FNBEN48 48"
 #FNBEN60 60"
 #FNBEN72 72"

Fulton Expandable Bench

#FNEXB



BENCHES



Leg Bench Options L to R
Specify leg style by adding selected Leg SKU to end of Bench SKU
#L1 Brookline
#L4 Hoosier
#L9 Round Shaker
#L10 Classic Shaker



Leg Bench has leg style option

Leg Bench
13" d x 18" h
36" w #LBEN36L10
48" w #LBEN48L10
60" w #LBEN60L10
72" w #LBEN72L10

Leg Expandable Bench (not shown)
#LEXB
48"-96" w x 13" d x 18" h



Gibson Expandable Bench
#GBEXB
48"-96" w x 13" d x 18" h

Gibson Bench
13" d x 18" h
36" w #GBBEN36
48" w #GBBEN48
60" w #GBBEN60
72" w #GBBEN72



Henning Bench
#HGBEN54
54" w x 16" d x 18" h



Hayworth Bench
13" d x 18" h
36" w #HHBEN36
48" w #HHBEN48
60" w #HHBEN60
72" w #HHBEN72



**Mission Bench
(not shown)**
13" d x 18" h
36" w #MNBEN36
48" w #MNBEN48
60" w #MNBEN60
72" w #MNBEN72

**Mission
Expandable Bench**
#MNEXB
48"-96" w x 13" d x 18" h
- Three 16" Leaves
- Leaf Holder

**Simplicity
Solid Top Bench**
#51-36BEN

Popular Sizes:
#51-36BEN 36"
#51-48BEN 48"
#51-60BEN 60"
#51-72BEN 72"

**Simplicity
Expandable Bench**
#51-1401EXB



Wasilla Bench
#WABEN36 36"
#WABEN48 48"
#WABEN60 60"
#WABEN72 72"

**Wasilla
Expandable Bench**
#WAEXB



Xander Live Edge Bench
16" d x 18" h
60" w #XRBN60
72" w #XRBN72
84" w #XRBN84
90" w #XRBN90



STORAGE

OPTIONS

Why, you ask, do we make our beautiful hutches, buffets, and sideboards in the time-honored tradition of handcrafted furniture- building?

**BECAUSE
YOU WOULDN'T
WANT IT ANY
OTHER WAY.**

We are true craftsmen, dedicated to building and finishing every piece of furniture by hand, one piece at a time. Because you wouldn't expect any less from Fusion Designs.

HUTCHES

Caspian



Caspian Hutch

#CPBFT40 (2-door)
42 1/2" w x 20" d x 46" h

#CPBFT60 (3-door)
60 1/2" w x 20" d x 46" h

#CPBFT80 (4-door)
80 1/2" w x 20" d x 46" h

- Flush doors with light guard
- Antique glass sides
- Leaded glass doors
- Open deck
- Touch lighting
- Soft-close doors
- Mirror back (#MB)
- Hardware options
(see Features & Options)

Caspian Buffet

#CPBFB40 (2-door)
40" w x 20" d x 34" h

#CPBFB60 (3-door)
58" w x 20" d x 34" h

#CPBFB80 (4-door)
76" w x 20" d x 34" h

- Optional silverware drawer insert (#SRD)

Total height buffet with hutch is 80"

- 1 fixed shelf in base
- 1 adjustable glass shelf w/ plate groove in top

Classic



Classic Hutch

#CCBFT40 (2-door)
40" w x 20" d x 46" h

#CCBFT56 (3-door)
56" w x 20" d x 46" h

#CCBFT72 (4-door)
72" w x 20" d x 46" h

- Beveled glass in doors
- Recessed touch lighting
- Soft-close doors

Classic Buffet

#CCBFB40 (2-door)
38 7/8" w x 20" d x 34" h

#CCBFB56 (3-door)
56 3/8" w x 20" d x 34" h

#CCBFB72 (4-door)
72" w x 20" d x 34" h

- Soft-close doors & drawers
- Hardware options (see Features & Options)
- Optional silverware drawer insert (#SRD)

Total height buffet with hutch is 80"

- 1 fixed shelf in base
- 1 glass shelf w/ plate groove in top

Edmonton



Edmonton Corner Hutch
#ENBFT

- 46" w x 25" d x 56.5" h
- Recessed touch lighting
 - Inset doors
 - Soft-close doors

Edmonton Corner Buffet
#ENBFB

- 32 1/2" w x 25" d x 34" h
- Soft-close doors
 - Hardware options (see Features & Options)

Standard hardware is E-5

Total height buffet with hutch is 90.5"

- 1 shelf in base
- 2 shelves in top

Elara Display Chest



Elara Display Chest

#EADPC
40" w x 19" d x 78" h
Chest Top: 40" w

- Soft-closing, full extension, undermount drawer guides
- Dovetailed, solid wood drawers
- Recessed touch lighting
- Soft-close doors
- Display Chest includes 2 Adjustable glass shelves

See hardware page in Features and Options section



Farmville

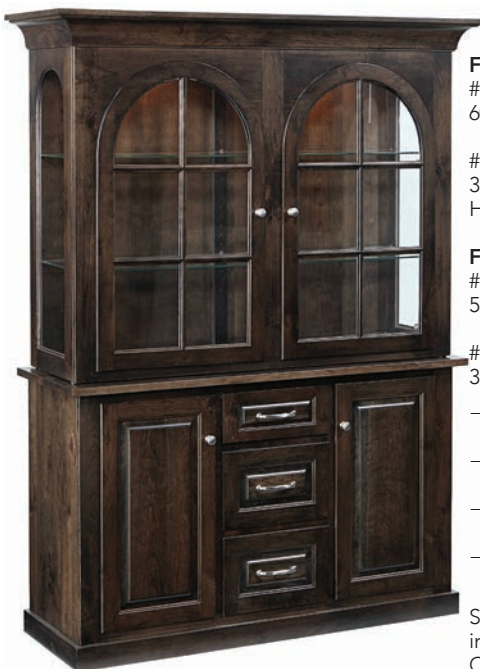

Farmville Hutch

#FEBFT (2 Door)
60.5" w x 20" d x 46 1/2" h

#FEBFT35 (1 Door)
35" w x 20" d x 46 1/2" h
Hutch Top: 35" w

Farmville Buffet
#FEBF (3 Drawer, 2 Door)
57" w x 20" d x 35" h

#FEBF31 (1 Drawer, 2 Door)
31" w x 20" d x 35" h

- Soft-closing, full extension, undermount drawer slides
- Soft closing doors on buffet only
- Dovetailed, solid wood drawers
- Recessed touch lighting

See hardware page in the Features & Options section

Total height buffet with hutch is 81 1/2"

- 2 shelves per section in base
- 2 shelves in top

Hayworth



Hayworth Hutch

#HHBFT46 (2-door)
47" w x 21 1/2" d x 46" h

#HHBFT62 (3-door)
62" w x 21 1/2" d x 46" h

#HHBFT80 (4-door)
80" w x 21 1/2" d x 46" h

- Recessed touch lighting
- Beveled glass doors
- Soft-close doors
- Ebony inlays

Hayworth Buffet
#HHBFB46 (2-door)
43 1/2" w x 21 1/2" d x 35" h

#HHBFB62 (3-door)
61 1/2" w x 21 1/2" d x 35" h

#HHBFB80 (4-door)
76 1/2" w x 21 1/2" d x 35" h

- Soft-close drawers & doors
- Optional silverware drawer insert (#SRD)
- Mirror back (#MB)

Total height buffet with hutch is 81"

- 1 shelf in base
- 1 shelf in top

HUTCHES

Tuscana



Tuscana Hutch

- #TABFT50
64" w x 20" d x 41" h
- Recessed touch lighting
 - Soft-close doors
 - Optional mirror back (#MB)

Tuscana Buffet

- #TABFB
60" w x 20" d x 40" h
- Soft-closing, full extension, undermount drawer slides
 - Dovetailed, solid wood drawers
 - Hardware (see Features & Options)
 - Optional silverware drawer insert (#SRD)

Total height buffet with hutch is 81"
- 1 shelf per door in base
- 1 shelf per door in top

Wellington



Wellington Hutch

- #WNBFT
48" w x 20" d x 22" h
- Recessed touch lighting
 - 3" crown molding
 - Soft-close doors

Wellington Buffet

- #WNBFB
46" w x 20" d x 44" h
- Soft-closing, full extension, undermount drawer slides
 - Dovetailed, solid wood drawers
 - 1" thick top
 - Raised-panel doors
 - Optional silverware drawer insert (#SRD)
 - Hardware (see Features & Options)

Total height buffet with hutch is 66"
- 1 shelf in base
- No shelves in top



PIE SAFES

Old Mission Pie Safe

#OMBF35

35 1/4" w x 17 1/2" d x 46 3/4" h

- Soft-closing, full extension, undermount drawer slides
- Dovetailed solid wood drawers
- Soft-close doors
- Hardware (see Features & Options)
- 2 shelves



BUFFETS & SIDEBOARDS

Bartlett



#BRBF54 (2-door)
54"w x 20"d x 40"h

#BRBF60 (2-door)
60"w x 20"d x 40"h

#BRBF72 (2-door)
72"w x 20"d x 40"h

#BRBF454 (4-door)
54"w x 20"d x 40"h

#BRBF460 (4-door)
60"w x 20"d x 40"h

#BRBF472 (4-door)
72"w x 20"d x 40"h

- Soft-closing, full extension, undermount drawer slides
- Soft closing doors
- Dovetailed, solid wood drawers
- 1 shelf per section
- 4-door unit comes with doors and shelf instead of wine rack
- See hardware page in Features & Options section

Celina Buffet



#CLBF54 (4 door, 1 drawer)
54"w x 20"d x 40"h

#CLBF60 (4 door, 1 drawer)
60"w x 20"d x 40"h

#CLBF72 (4 door, 1 drawer)
72"w x 20"d x 40"h

- Soft-closing, full extension, undermount drawer slides
- Soft closing doors
- Dovetailed, solid wood drawers
- Radius doors
- Outside doors, 1 shelf per door stationary (if no wine rack, 1 shelf in center)

Copenhagen Leaf Storage Cabinet



#CHBF60 60"

60"w x 19"d x 36"h

- Available size: 60" length- 60" stores 36", 42", or 48" long leaves
- 36" standard height
- Standard depth is 19" and will need to add 6" in depth to store 16" wide leaves
- Cabinets can store up to 10 leaves w/ skirt
- Standard with two adjustable shelves

Elara Shelf Chest



#EASC

38"w x 18"d x 38"h

- Shelf chest includes 2 adjustable shelves that can be used as wine bottle holders or regular shelves
- See hardware page in Features and Options section

Elara Door Chest



- Elara Door Chest & Elara Shelf Chest
Individual units can be combined to form
1 large buffet

- #EADC
38" w x 18" d x 38" h
- Soft-close doors
- Includes 2 adjustable shelves
- See hardware page in Features and Options section

Gibson High Buffet



- #GBHBF44 (2-door, 4-drawer) 44" w x 20" d x 50" h
- Flush doors with light guard
- Multi-setting touch lights
- 1 adjustable glass shelf
#GBHBF56 (3-door, 4-drawer) 56" w x 20" d x 50" h
- Soft closing undermount drawer guides
- Soft closing doors
#GBHBF68 (4-door, 6-drawer) 68" w x 20" d x 50" h
- Dovetailed solid wood drawers
- Hardware (see Features & Options)
- Optional silverware drawer insert (#SRD)

Goshen Buffet



- #GNBF60
60" w x 20" d x 40" h
- Textured glass
- 1 adjustable wood shelf
- Inset doors and drawers
- Soft-closing, full extension, undermount drawer slides
- Dovetailed solid wood drawers
- Soft-close doors
- Hardware (see Features & Options)
- Optional silverware drawer insert (#SRD)

Harmony Buffet



- #HYBF65ST03
65" w x 19" d x 36" h
#HYBF35RT03
34 3/4" w x 19" d x 36" h

*See pages 132 & 133 for options and details for the Harmony Buffets



BUFFETS & SIDEBOARDS

Hayworth Buffet



- #HHBFB46 (2-door)
(2 door, 2 drawer)
43 1/2" w x 21 1/2" d x 35" h
- Soft-closing, full extension, undermount drawer slides
- Dovetailed, solid wood drawers
- #HHBFB62 (3-door)
61 1/2" w x 21 1/2" d x 35" h
- Soft-close doors
- Ebony Inlays
- #HHBFB80 (4-door)
(4 door, 3 drawer)
76 1/2" w x 21 1/2" d x 35" h
- Hardware (see Features & Options)
- Optional silverware drawer insert (#SRD)
- 1 shelf in base

Simplicity Server



- #51-1101
56" w x 19" d x 36" h
- Features Walnut base
- Inlays are standard

Simplicity Curio Cabinet



- #51-1001
38" w x 15" d x 60" h
- Features Walnut base
- Inlays are standard

Tuscana Closed Buffet



- #TABFB
60" w x 20" d x 40" h
- Solid wood dovetailed drawers
- Soft-close doors
- Hardware (see Features & Options)
- Optional silverware drawer insert (#SRD)
- 1 shelf per door

Tuscana Open Buffet



- #TAOBF
60"w x 20"d x 40"
– Dovetailed solid wood drawers
– Inset doors & drawers
– 1 shelf per door
– Hardware (see Features & Options)
– Optional silverware drawer insert (#SRD)

Wellington Buffet



- #WNBFB
46"w x 20"d x 44"h
– 1 shelf in base
– Inset doors and drawers
– Raised panel doors
– Hardware (see Features & Options)
– Optional silverware drawer insert (#SRD)
– Soft-closing, full extension, undermount drawer slides
– Dovetailed, solid wood drawers
– 1" thick top



35" BUFFET OPTIONS, #HYBF35

BUFFET FEATURES

- Dovetailed drawer box
- Soft close slides
- Adjustable shelf
- Reversible wine glass holder shelf
- Spice rack in drawer
- Removable Fusion Designs cutting board



Spice Rack



Cutting Board Front



Cutting Board Back

RAISED PANEL

REVERSE PANEL

GLASS PANEL

BLOCK LEGS



#RB



#SB



#GB

TAPERED LEGS



#RT



#ST



#GT

TURNED LEGS



#RS



#SS



#GS

65" BUFFET OPTIONS, #HYBF65



Cutting Board Slot



Spice Rack



BUFFET FEATURES

- Dovetailed drawer box
- Soft close slides
- Adjustable shelf
- Reversible wine glass holder shelf
- Spice rack in drawer
- Removable Fusion Designs cutting board

RAISED PANEL

REVERSE PANEL

GLASS PANEL

BLOCK LEGS



#RB



#SB



#GB

TAPERED LEGS



#RT



#ST



#GT

TURNED LEGS



#RS



#SS



#GS



LIVING ROOM

COLLECTIONS

Imagine the compliments you'll get when your guests' eyes are drawn to your classically modern occasional table from Fusion Designs.

HONORING THE PAST DESIGNED FOR THE FUTURE.

Many furniture makers follow traditional designs primarily in the Mission or Arts and Crafts style. While we adhere to quality craftsmanship and attention to detail, our designs are innovative and imaginative.

ADDISON

collection

COLLECTION FEATURES

- Solid wood featuring plywood veneer tops

COLLECTION OPTIONS

- Distressed finish (#2D)
- Two-tone finish (#2TN)



Addison Sofa Table

#ANST

55" w x 14" d x 32" h

Addison Coffee Table

#ANCT

48" w x 28" d x 18" h



Addison End Table

#ANET

20" w x 20" d x 22" h



BUNGALOW MISSION

collection

COLLECTION FEATURES

- 1" tops
- Dovetailed, maple drawers
- Premium soft-close, undermount drawer glides
- H-8 hardware

COLLECTION OPTIONS

- Distressed finish (#2D)
- Two-tone finish (#2TN)
- Hardware options (see Features & Options)



**Bungalow Mission
1 Drawer End Table**
#13-2501
21" w x 25" d x 24" h



**Bungalow Mission
26" Round End Table**
#13-2504
26" w x 26" d x 26" h

**Bungalow Mission
30" Round End Table**
#13-2505
30" w x 30" d x 26" h



**Bungalow Mission
Phone Stand**
#13-2507
19" w x 17" d x 28 1/2" h



**Bungalow Mission
Magazine Rack**
#13-2506
19 3/4" w x 13" d x 14" h



**Bungalow Mission
3 Drawer Coffee Table**
#13-2502
53" w x 25" d x 18" h

All items shown in
Quartersawn Oak with
#32 Michaels finish

All items shown in
Quartersawn Oak with
#32 Michaels finish

**Bungalow Mission
3 Drawer Sofa Table**
#13-2503
53" w x 19" d x 30" h



**Bungalow Mission
Bookcase 6 Shelves**
#13-2906
38" w x 13" d x 80" h

**Bungalow Bookcase
5 Shelves**
#13-2905
38" w x 13" d x 72" h

**Bungalow Mission
Bookcase 4 Shelves**
#13-2904
38" w x 13" d x 65" h

**Bungalow Bookcase
3 Shelves**
#13-2903
38" w x 13" d x 52" h



**Bungalow Mission
Bookcase 2 Shelves**
#13-2902
38" w x 13" d x 40" h

**Bungalow Mission
Bookcase 1 Shelf**
#13-2901
38" w x 13" d x 30" h



**Bungalow Mission
Single Door Bookcase**
#13-2907
32" w x 13 1/2" d x 60 1/2" h



**Bungalow Mission
Double Door Bookcase**
#13-2908
63" w x 13 1/2" d x 60 1/2" h

BUNGALOW MISSION

collection

CONTINUED...

All items shown in
Quartersawn Oak with
#32 Michaels finish



**Bungalow Mission
Club Chair**
#13-2301L Leather
#13-2301F Fabric
36 1/4" w x 38" d x 39" h
Stationary

**Bungalow Mission
Morris Chair**
#13-2310L Leather
#13-2310F Fabric
35" w x 37 3/4" d x 44" h
Reclines



**Bungalow Mission
Ottoman**
#13-2311L Leather
#13-2311F Fabric
25" w x 15" d x 17" h



**Bungalow Mission
Love Seat**
#13-2303L Leather
#13-2303F Fabric
60 3/4" w x 38" d x 39" h



Bungalow Mission Sofa
#13-2302L Leather
#13-2302F Fabric
84 3/4" w x 38" d x 39" h

CAMPBELL

collection

COLLECTION FEATURES

- Roundover edge on 1" thick tops
- Dovetailed, solid wood drawers
- Soft-closing, full extension, undermount drawer guides
- Soft-close doors
- N-14 knobs

COLLECTION OPTIONS

- Distressed finish (#2D)
- Two-tone finish (#2TN)



All items shown in
Brown Maple with
#49 Onvx finish



Campbell 16" End Table

#4CAET16
16" w x 24" d x 24" h

Campbell 22" End Table

#4CAET22
22" w x 24" d x 24" h

Campbell Sofa Table

#4CAST
54" w x 19" d x 30" h

Campbell Coffee Table

#4CACT
48" w x 28" d x 19" h



CASTLEBROOK

collection

COLLECTION FEATURES

- 1" tops with bread board ends
- Dovetailed, maple drawers
- Premium soft-close, undermount drawer glides
- Yellowheart wood inlays
- W-2 hardware

COLLECTION OPTIONS

- Distressed finish (#2D)
- Two-tone finish (#2TN)
- Hardware options (see Features & Options)

All items shown in
Quartersawn White Oak with
#30 Asbury finish



Castlebrook 42" Coffee Table
#4CKC42
42"w x 24"d x 18"h

Castlebrook 48" Coffee Table
(not shown)
#4CKC48
48"w x 28"d x 18"h

Castlebrook 16" End Table
#4CKE16
16"w x 26"d x 24"h

Castlebrook 23" End Table
(not shown)
#4CKE23
23"w x 26"d x 24"h

Castlebrook Sofa Table
#4CKS
54"w x 16"d x 29 1/2"h



HIGHLAND

collection



Highland Club Chair
#HL-2301L Leather
#HL-2301F Fabric
36 1/4" w x 38" d x 39" h
Stationary



Highland Morris Chair
#HL-2310L Leather
#HL-2310F Fabric
35" w x 37 3/4" d x 44" h
Reclines



Highland Love Seat
#HL-2303L Leather
#HL-2303F Fabric
60 3/4" w x 38" d x 39" h



Highland Sofa
#HL-2302L Leather
#HL-2302F Fabric
84 3/4" w x 38" d x 39" h



Highland Ottoman
#HL-2311L Leather
#HL-2311F Fabric
25" w x 15" d x 17" h

MEMPHIS (CLOSED) *collection*

COLLECTION FEATURES

- 1" thick reverse-bevel tops
- Fully inset drawer & door fronts
- 1-9 knobs
- Soft-close drawers & doors

COLLECTION OPTIONS

- Distressed finish (#2D)
- Two-tone finish (#2TN)

See matching Memphis pieces in the Entertainment section.



All items shown in
Quartersawn White Oak with
#30 Asbury finish

Memphis Closed End Table

#4MYET

22" w x 20" d x 24" h

Memphis Closed Coffee Table

#4MYCT

42" w x 22" d x 17 1/2" h

Memphis Closed Sofa Table

#4MYST

48" w x 16" d x 29 1/2" h



MEMPHIS (OPEN) *collection*

COLLECTION FEATURES

- 1" thick reverse-bevel tops
- Fully inset drawer fronts
- Arched top aprons
- I-9 knob
- Soft-closing, full-extension, undermount drawer guides

COLLECTION OPTIONS

- Distressed finish (#2D)
- Two-tone finish (#2TN)

See matching Memphis pieces in the Entertainment section.

All items shown in Quartersawn White Oak with #30 Asbury finish



Memphis Open Coffee Table

#4MYOCT
48" w x 28" d x 17 1/2" h

Memphis Open Sofa Table

#4MYOST
54" w x 16" d x 29 1/2" h

Memphis Open 23" End Table

#4MYOET23
23" w x 26" d x 24" h

Memphis Open 16" End Table

#4MYOET16
16" w x 26" d x 24" h



PACIFIC *collection*

COLLECTION FEATURES

- Coffee table features 2 hidden drawers
- Nesting tables 2" thick

All items are shown in Brown Maple wood with #113 Oatmeal finish



Pacific Coffee Table
#PCCT
31" w x 31" d x 16" h

Pacific Nesting Table
#PCNT
21 1/8" w x 14 3/4" d x 23 7/8" h

Pacific Small Nesting Table
#PCNTS
16" w x 11 3/4" d x 18 7/8" h



PLATTE RIVER

collection

COLLECTION FEATURES

- 1" tops
- Dovetailed, maple drawers
- Premium Side mount ball bearing glides
- SO-1 hardware

COLLECTION OPTIONS

- Distressed finish (#2D)
- Two-tone finish (#2TN)
- Hardware options (see Features & Options)



**Platte River
Coffee Table**
#PRCT
42" w x 22" d x 17" h



**Platte River Lift
Top Coffee Table**
#PRLCT
42" w x 22" d x 17" h



**Platte River End
Table**
#PRET
20" w x 20" d x 21" h



**Platte River Sofa
Table**
#PRST
54" w x 16" d x 30" h

SIMPLICITY *collection*

COLLECTION FEATURES

- 1" tops
- Dovetailed, maple drawers
- Premium soft-close, undermount drawer glides
- Features a walnut bowtie inlay in tops
- Drawer front cutout as the hardware

All items are shown in Brown Maple wood with #99 Toffee finish

COLLECTION OPTIONS

- Distressed finish (#2D)
- Two-tone finish (#2TN)



**Simplicity
Cocktail Table**
#51-2503
48" w x 26" d x 19" h



**Simplicity
Chairside Table**
#51-2501
18" w x 25" d x 24" h



**Simplicity
End Table**
#51-2502
22" w x 27" d x 23" h



**Simplicity
2 Drawer Desk**
#51-2801
50" w x 18" d x 30" h



**Simplicity
Console Table**
#51-2504
50" w x 18" d x 30" h

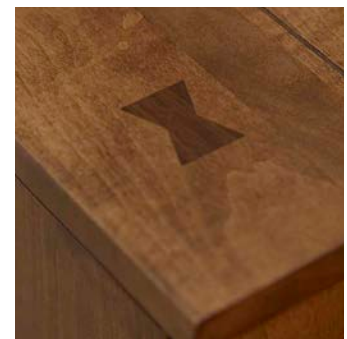

Tops features **Walnut Inlays**

SIMPLICITY

collection

CONTINUED...



Simplicity Morris Chair
35" w x 37 3/4" d x 44" h
#SPMCF- Fabric
#SPMCL- Leather
Reclines



Simplicity Club Chair
42 1/2" w x 38" d x 39" h
#SPCCF- Fabric
#SPCCL- Leather
Stationary

Bottom frames feature
Walnut boards as standard



Simplicity Ottoman
25" w x 15" d x 17" h
#SPONF- Fabric
#SPONL- Leather



Simplicity Loveseat
60" w x 38" d x 39" h
#SPLSF- Fabric
#SPLSL- Leather



Simplicity Sofa
84" w x 38" d x 39" h
#SPSAF- Fabric
#SPSAL- Leather



All arms feature a
Walnut Bowtie Inlay

SOMA

collection

All items are shown in Brown Maple wood with #113 Oatmeal finish.

COLLECTION FEATURES

- 1" tops
- Dovetailed, maple drawers
- Premium soft-close, undermount drawer glides
- SO-1 hardware

COLLECTION OPTIONS

- Distressed finish (#2D)
- Two-tone finish (#2TN)
- Hardware options (see Features & Options)



Soma End Table
#SET
24" w x 28" d x 24" h



Soma Sofa Table
#SST
64" w x 16" d x 29 1/2" h



Soma Console
#SCT
72" w x 14" d x 24" h



Soma Coffee Table
#SCFT
48" w x 18" d x 28" h

ENTERTAINMENT

COLLECTIONS

Whatever your available space, whatever feature you desire, whatever persona you want to add to your room's decor, Fusion Designs offers a media center that's adaptable to your needs.

PERFECT FIT AND FUNCTION.

All of our beautiful cabinets, hutches, and towers are crafted to provide an aesthetically pleasing look and long-lasting use.

Media Consoles

HAYWORTH

COLLECTION FEATURES

- Constructed using solid wood
- Dovetailed, solid wood drawer boxes
- Undermount, soft-closing drawers
- Ebony Wood Inlay
- N-14 Black Hardware

COLLECTION OPTIONS

- Hardware Options
(see Features & Options page)
- No Inlay



Hayworth 64\" Entertainment Console
#HHTV64
64\"w x 19\"d x 32\"h

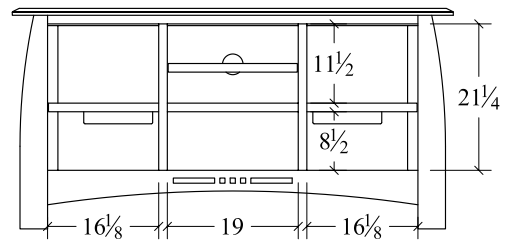

Hayworth 74\" Entertainment Console
#HHTV74
74\"w x 19\"d x 32\"h

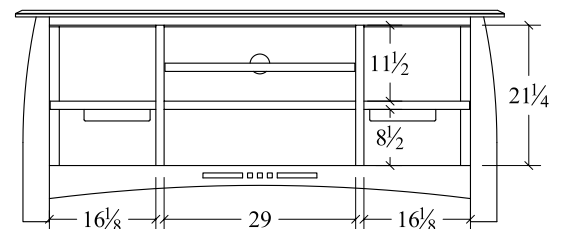

All items shown in
Quartersawn White Oak with
#99 Toffee finish

Media Consoles

MEMPHIS

COLLECTION FEATURES

- Dovetailed solid wood drawers
- Soft-close doors & drawers
- I-9 hardware

Media Unit Features

- 2 CD/DVD accessible drawers
- 1 adjustable shelf behind each door
- KV ball bearing, full-extension slides
- Smoked glass in doors

COLLECTION OPTIONS

- Hardware Options
(see Features & Options page)

See matching Memphis pieces in the Living Room section.

All items shown in
Quartersawn White Oak with
#32 Michaels Cherry finish

15"	18.625"	10.375"	
7.25"	30.25"		
18" Model Interior Depth 15.5"			

15"	18.625"	10"	
7.25"	24.25"		
18" Model Interior Depth 15.5"			

15"	18.625"	
7.25"	38.5"	
18" Model Interior Depth 15.5"		



**Memphis 49"
Media Console**
#4MYTVS49
49" w x 18" d x 29 1/2" h

**Memphis 60"
Media Console**
#4MYTVS60
60" w x 18" d x 29 1/2" h

**Memphis 72"
Media Console**
#4MYTVS72
72" w x 18" d x 29 1/2" h

PLATTE RIVER

COLLECTION FEATURES

- Constructed using solid wood
- Dovetailed, solid wood drawer boxes
- Soft closing doors
- BH-2 Knobs, SO-1 Pulls hardware
- 1 shelf behind each door

COLLECTION OPTIONS

- Hardware options
(see Features & Options)



Platte River 60" Console

#PRTV60

60" w x 21" d x 32" h

Platte River 72" Console

#PRTV72

72" w x 21" d x 32" h

SOMA

COLLECTION FEATURES

- Constructed using solid wood
- Dovetailed, solid wood drawer boxes
- Soft closing doors
- SO-1 Knob hardware
- 1 shelf behind each door

COLLECTION OPTIONS

- Hardware options
(see Features & Options)

All items are shown in Brown Maple wood with #113 Oatmeal finish.



Soma Open 60" Console

#SOET60

60" w x 18" d x 30" h

Soma Open 72" Console

#SOET72

72" w x 18" d x 30" h

Soma Closed 60" Console

#SCET60

60" w x 18" d x 30" h

Soma Closed 72" Console

#SCET72

72" w x 18" d x 30" h



Media Consoles

VILLA

COLLECTION FEATURES

- Constructed using solid wood
- Dovetailed drawers
- Side mounted, full extension drawer guides
- Removable backs
- Vented adjustable shelves & floors
- Soft-close doors

COLLECTION OPTIONS

- Flip down glass door (#OGD)
- Hardware Options (see Features & Options page)
- Drawer in place of sound bar opening (#OD)

See Features & Options page for details

All items shown in Cherry with #68 Hazelnut finish



Villa 47" Media Console
#VATV47
47" w x 21" d x 32" h

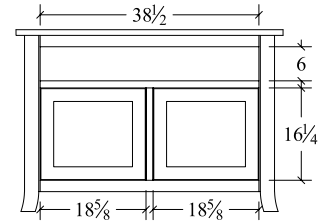

Villa 57" Media Console
#VATV57
57" w x 21" d x 32" h

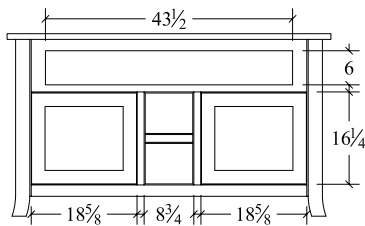

Villa 67" Media Console
#VATV67
67" w x 21" d x 32" h

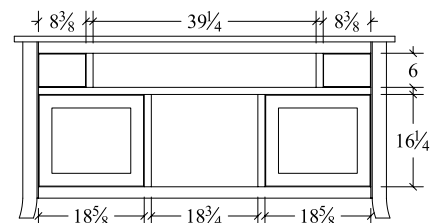





OFFICE

COLLECTIONS

Our office furniture reflects the growing enthusiasm in a crafted furniture experience for the home. With talented artisans using time-honored techniques passed down through generations, these are timeless pieces that will never pass out of style.

**FURNITURE
MEANT TO BE ENJOYED
FOR GENERATIONS.**

OFFICE COLLECTIONS

Livonia Channel Back

**Livonia Channel Back
Upholstered Chair**

#LVACCF

25" w x 20" d x 37" h

- Fabric #LVACCF

- Leather #LVACCL

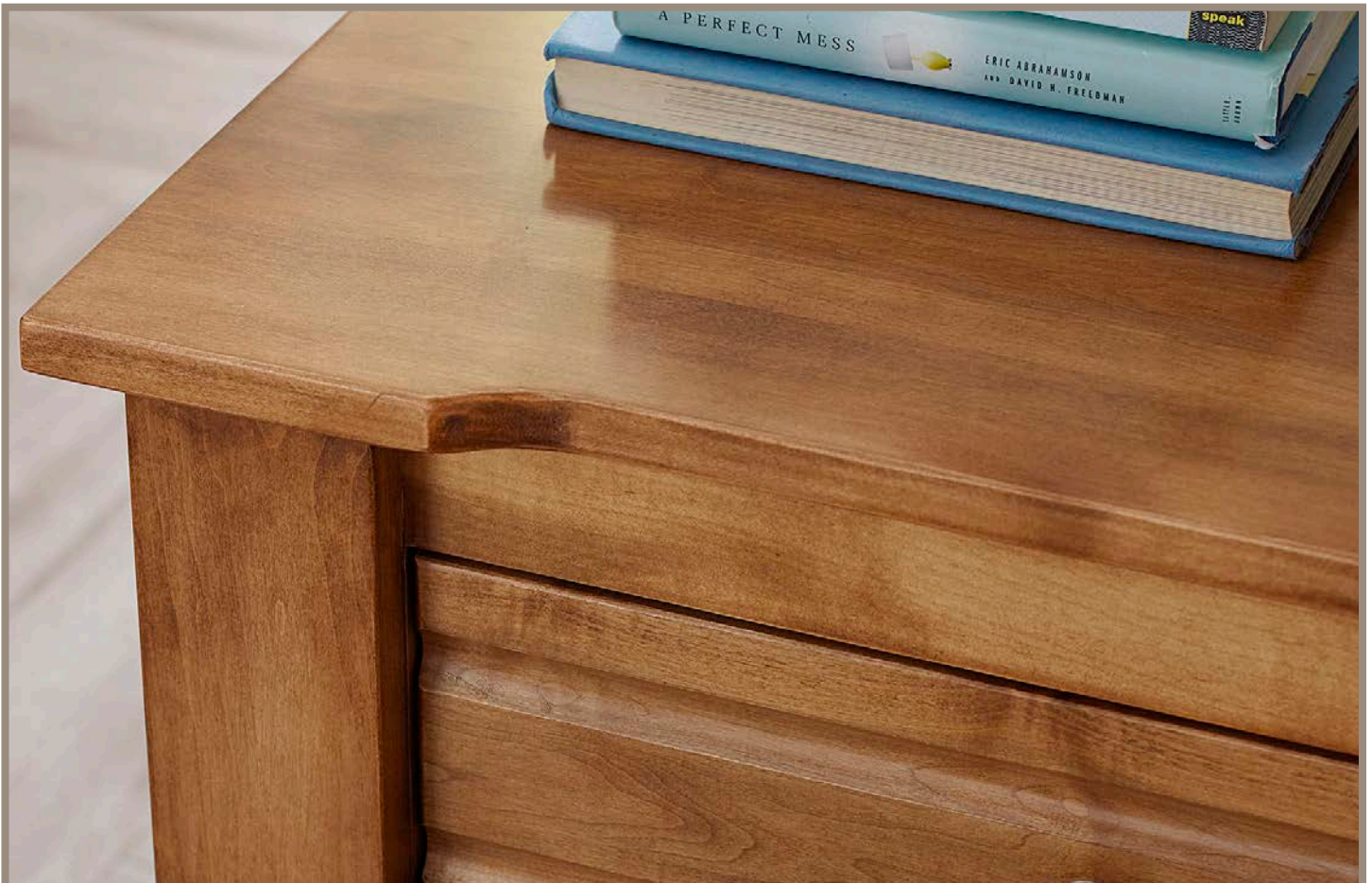

Platte River

COLLECTION FEATURES

- Constructed using solid wood
- Dovetailed, solid wood drawer boxes
- Sidemounted slides

Executive Desk Features

- Electrical/USB port
- SO-1 hardware

Bookshelf Features

- Adjustable shelves

COLLECTION OPTIONS

- Hardware Options
(see Features & Options page)

*Not available as custom

All items are shown in Brown Maple wood with #113 Oatmeal finish.

Power Port/USB



Platte River Executive Desk
#PRDK66
66"W x 24"D x 30"H



Platte River Writing Desk
#PRDK48
48"W x 24"D x 30"H



Platte River File Cabinet
#PRFC2D
19.5"W x 24"D x 30"H

Platte River 72" Bookshelf
#PRBK72, 4 shelves
36"W x 14"D x 72"H



OFFICE COLLECTIONS



Platte River



Platte River 30" Bookshelf
#PRBK30, 1 shelf
36"W x 14"D x 30"H



Platte River 36" Bookshelf
#PRBK36, 2 shelves
36"W x 14"D x 36"H



Platte River 48" Bookshelf
#PRBK48, 3 shelves
36"W x 14"D x 48"H



Platte River 60" Bookshelf
#PRBK60, 3 shelves
36"W x 14"D x 60"H

Platte River

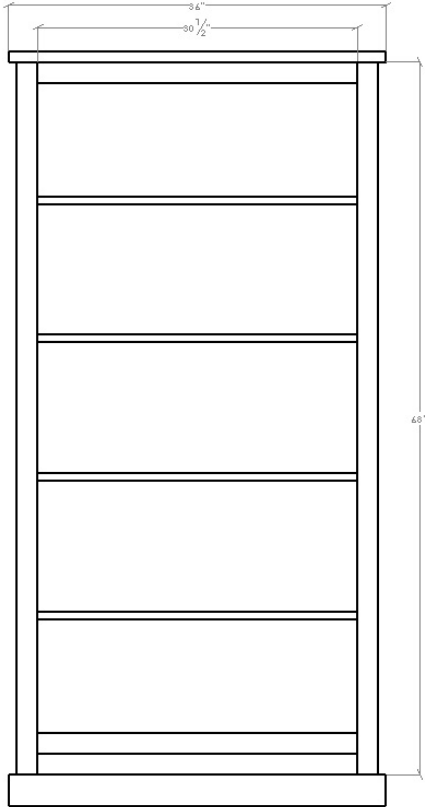

Platte River 72" Bookshelf
#PRBK72, 4 shelves
36"W x 14"D x 72"H

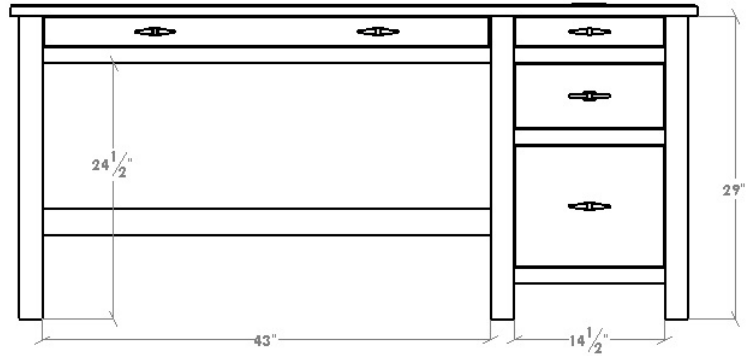

Platte River Executive Desk
#PRDK66
66"W x 24"D x 30"H

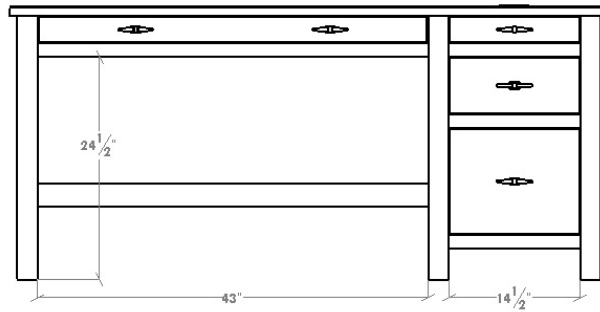

Platte River Writing Desk
#PRDK48
48"W x 24"D x 30"H

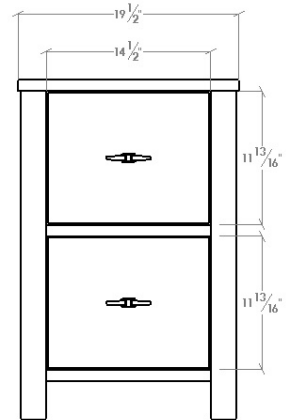

Platte River File Cabinet
#PRFC2D
19.5"W x 24"D x 30"H

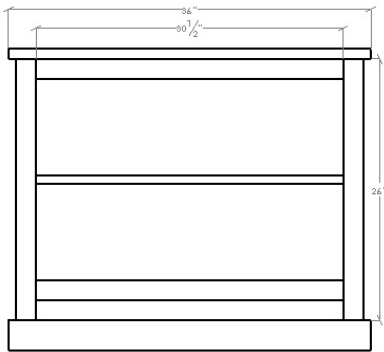

Platte River 30" Bookshelf
#PRBK30, 1 shelf
36"W x 14"D x 30"H

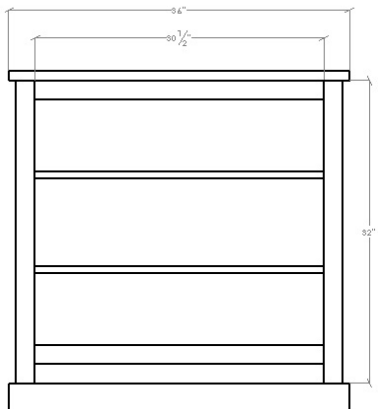

Platte River 36" Bookshelf
#PRBK36, 2 shelves
36"W x 14"D x 36"H

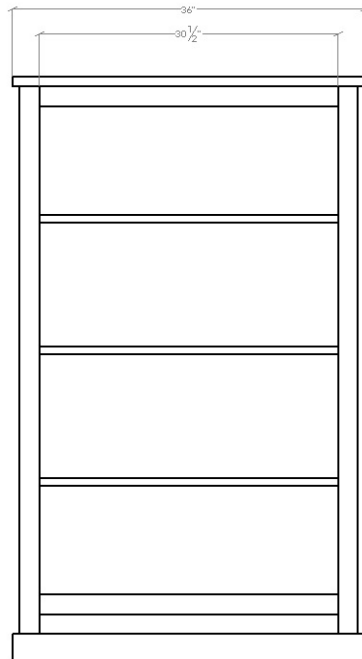

Platte River 60" Bookshelf
#PRBK60, 3 shelves
36"W x 14"D x 60"H

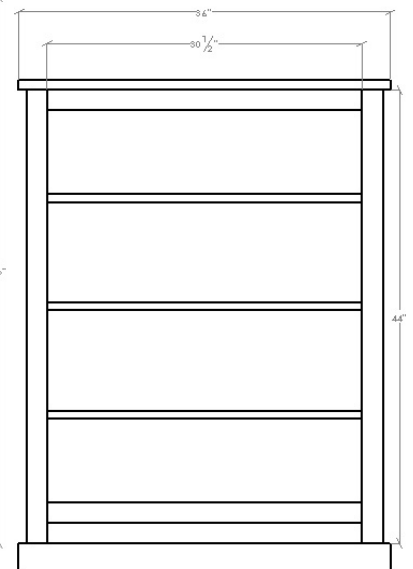

Platte River 48" Bookshelf
#PRBK48, 3 shelves
36"W x 14"D x 48"H

OFFICE COLLECTIONS

Simplicity

COLLECTION FEATURES

- Constructed using solid wood
- Dovetailed, solid wood drawer boxes
- Walnut bowtie inlays
- Side mount slides are used for superior strength
- Locks on file drawers
- USB features
- Electrical port on desk
- Flip down keyboard drawers
- Docking power stations
- Finished back panels
- Adjustable shelves in bookshelves
- Select pieces feature walnut bases as a standard

*Not available as custom



**Simplicity Desk
w/ 2 Drawers**

#51-2801

50" w x 18" d x 30" h

Shown in Brown Maple wood
with #99 Toffee finish.

Simplicity 72" Bookshelf

#SPBK72, 5 Shelves

40" w x 14 1/2" d x 72" h



Walnut base is standard



Simplicity 66" Drawer Desk

#SPDK66DT

66" w x 30" d x 30" h

Shown in Brown Maple wood
with #103 Dew finish



Flip Down Keyboard Drawers



**Simplicity Adjustable
60" Desk**
#SPDK60A
60"w x 24"d x 24 1/2 – 50"h
Features an electronic control module
with 4 preset height adjustments and
a plug in power strip



Features **Bowtie Inlays**
as standard



Walnut base
is standard



Simplicity File Cabinet

- #SPFCL2, 2-Drawer
38" w x 21" d x 30" h
- #SPFC2D, 2-Drawer
17" w x 25" d x 30" h
- # SPFC3D, 3-Drawer
17" w x 25" d x 41 1/4" h
- # SPFC3D, 3-Drawer
17" w x 25" d x 52 1/2" h

Shown in Brown Maple wood
with #103 Dew finish

Simplicity Desk Hutch

- #SPTP60
60" w x 16" d x 42" h
- #SPTP66
66" w x 16" d x 42" h
- #SPTP72
72" w x 16" d x 42" h

Shown in Brown Maple wood
with #103 Dew finish

OFFICE COLLECTIONS

Simplicity

- Simplicity Bookshelf**
- #SPBK30, 1 Shelf
40" w x 14 1/2" d x 30" h
 - #SPBK36, 2 Shelves
40" w x 14 1/2" d x 36" h
 - #SPBK48, 3 Shelves
40" w x 14 1/2" d x 48" h
 - #SPBK60, 4 Shelves
40" w x 14 1/2" d x 60" d
 - #SPBK72, 5 Shelves
40" w x 14 1/2" d x 72" h
 - #SPBK78, 5 Shelves
40" w x 14 1/2" d x 78" h
 - #SPBK84, 6 Shelves
40" w x 14 1/2" d x 84" h

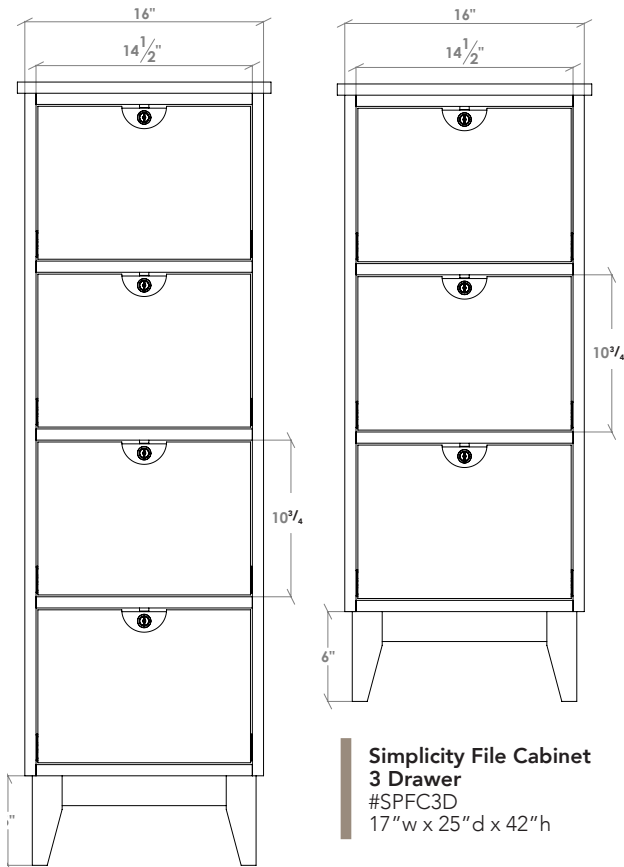

**Simplicity File Cabinet
3 Drawer**
#SPFC3D
17" w x 25" d x 42" h

**Simplicity File Cabinet
4 Drawer**
#SPFC4D
17" w x 25" d x 53" h

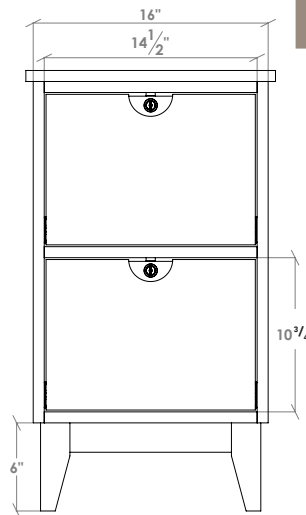

**Simplicity File Cabinet
2 Drawer**
#SPFC2D
17" w x 25" d x 30 1/2" h

**Simplicity File Cabinet
2 Drawer**
#SPFCL2
38" w x 21" d x 30 1/2" h

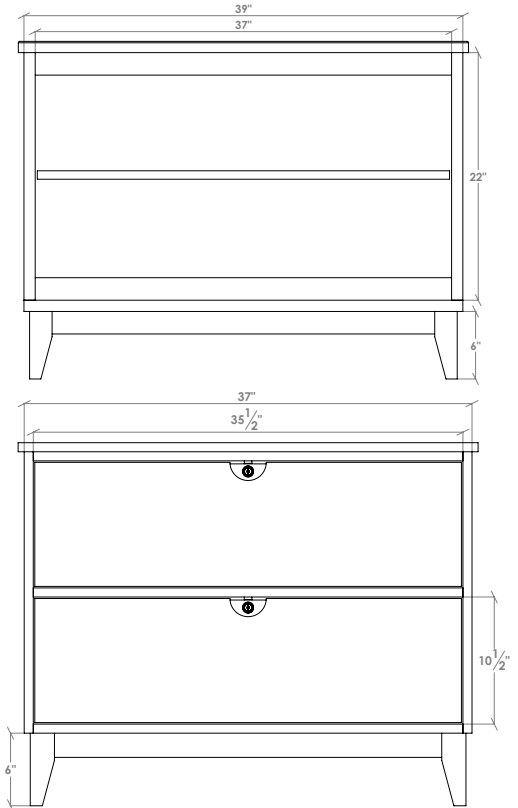

Simplicity 60" Desk Organizer
#SPDT60
60" w x 12 1/2" d x 8" h

Simplicity 66" Desk Organizer
#SPDT66
66" w x 12 1/2" d x 8" h

Simplicity 72" Desk Organizer
#SPDT72
72" w x 12 1/2" d x 8" h

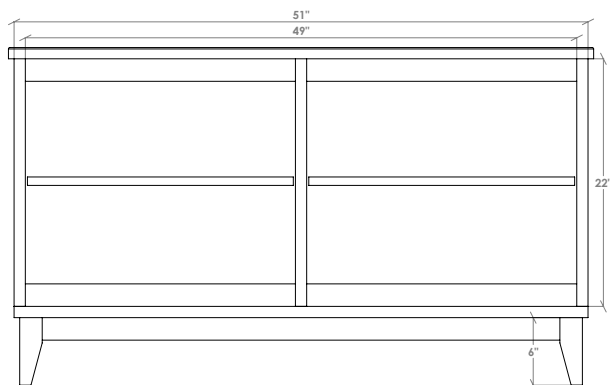

Simplicity Double Bookshelf

- #SPDBK30, 1 Shelf
52" w x 14 1/2" d x 30" h
- #SPDBK36, 2 Shelves
52" w x 14 1/2" d x 36" h
- #SPDBK48, 3 Shelves
52" w x 14 1/2" d x 48" h
- #SPDBK60, 4 Shelves
52" w x 14 1/2" d x 60" d
- #SPDBK72, 5 Shelves
52" w x 14 1/2" d x 72" h
- #SPDBK78, 5 Shelves
52" w x 14 1/2" d x 78" h
- #SPDBK84, 6 Shelves
52" w x 14 1/2" d x 84" h

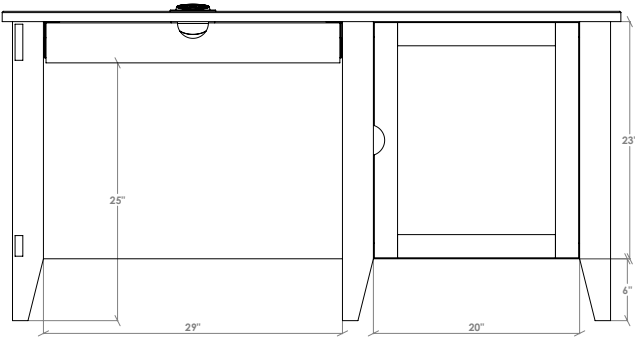

Simplicity 60" Door Desk
 #SPDK60DR
 60" w x 30" d x 30" h

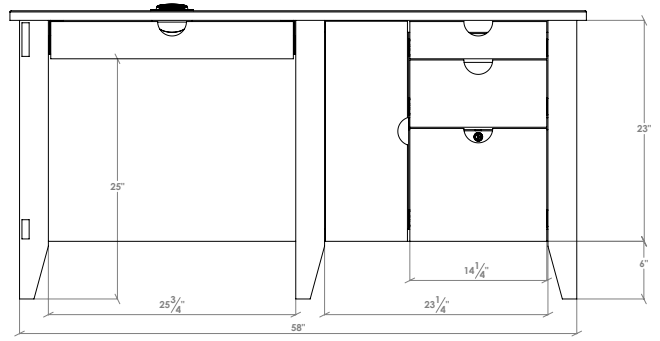

Simplicity 60" Drawer Desk
 #SPDK60DT
 60" w x 30" d x 30" h

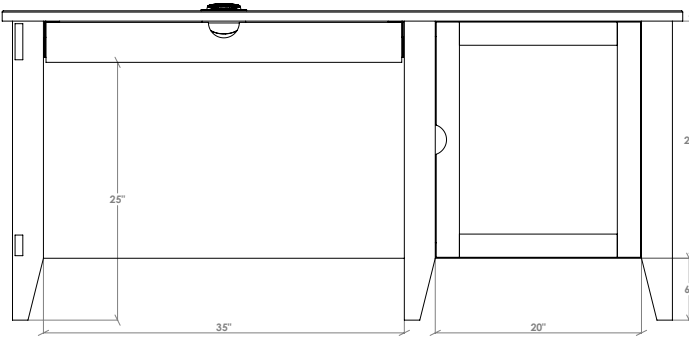

Simplicity 66" Media Door Desk
 #SPDK66DR
 66" w x 30" d x 30" h

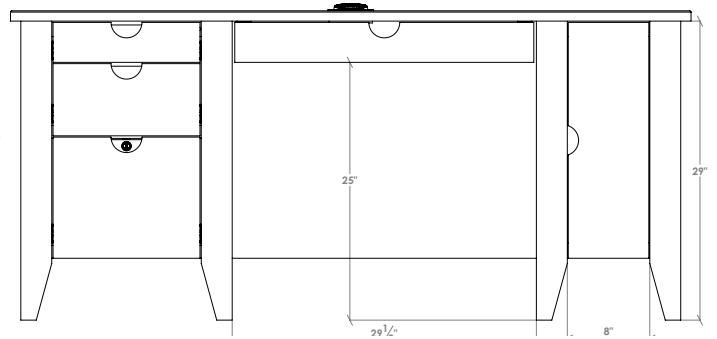

Simplicity 66" Media Drawer Desk
 #SPDK66MD
 66" w x 30" d x 30" h

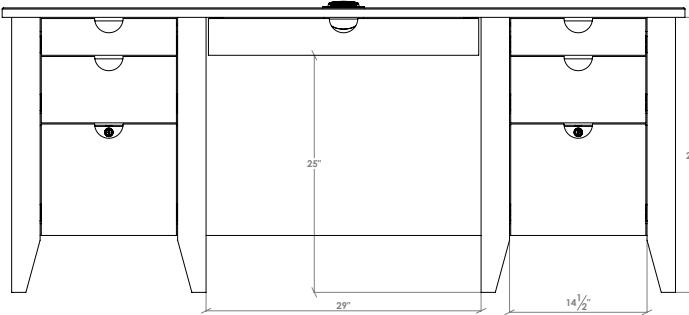

Simplicity 72" Drawer Desk
 #SPDK72DT
 72" w x 30" d x 30" h

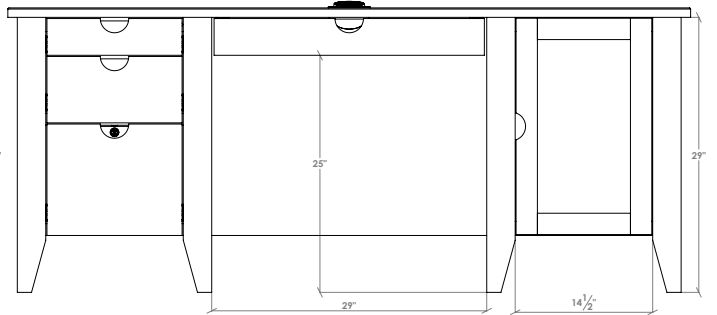

Simplicity 72" Door Desk
 #SPDK72DR
 72" w x 30" d x 30" h

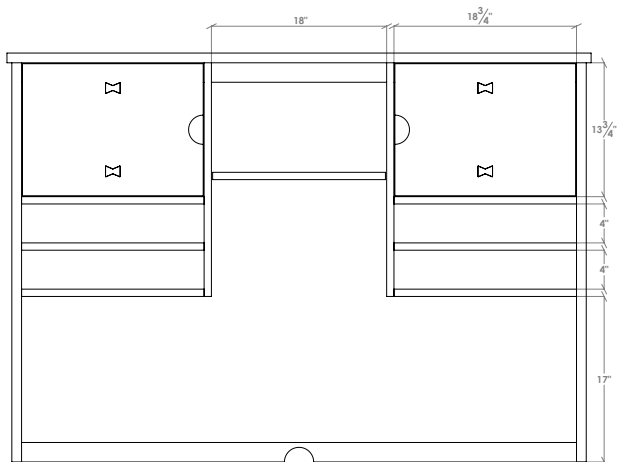

Simplicity Desk Hutch
 #SPTP60
 60" w x 16" d x 42" h
 #SPTP66
 66" w x 16" d x 42" h
 #SPTP72
 72" w x 16" d x 42" h

OFFICE COLLECTIONS

Traditional

Traditional Bookcase

#NC-2906

36" w x 14" d x 72" h

#NC-2905

36" w x 14" d x 48" h

#NC-2904

36" w x 14" d x 36" h

Shown in Oak wood with #33 Medium finish
– Adjustable shelves

*Not available as custom







BEDROOM

OPTIONS

Romp in bed with the kids. Sleep in on Sunday morning. Beds made by Fusion Designs are rugged and solid, yet cradle you in restful comfort. While other companies say they still make their furnishings mostly by hand...

**WE ALWAYS WILL.
THAT'S OUR
PLEDGE TO YOU.**

High-grade hardwoods and proven finishes mean that you can trust your bedroom furniture will last for many years. In fact, we guarantee it!

ADDISON *Bedroom Collection*

COLLECTION FEATURES

- Constructed with mortise and tenon joints
- Cast dovetailed brackets support mattress
- Hardware not available on other collections
- Dovetailed drawers
- Soft-close full extension drawers

COLLECTION OPTIONS

- Distressed finish (#2D)
- Hardware Options - see hardware page in Features & Options section
- Underbed Storage Options
- Dresser drawer available with felt lined jewelry tray (#SJT)
- See upholstery book for fabric and leather choices



**Hardware not available on other collections*



**Addison 3-Drawer
Nightstand**
#ADNS
26" w x 18 3/4" d x 30" h



**Addison 1-Drawer
Nightstand**
#ADNS1
26" w x 18 3/4" d x 30" h



Shown in Brown Maple with #115 Harbor Gray Finish



**Addison
5-Drawer Chest**
#ADCD
41" w x 22" d x 53 1/4" h



Addison Mirror
#ADMR
45 3/4" w x 38 1/4" h

**Addison
6-Drawer Dresser**
#ADDR
65" w x 22" d x 33 1/2" h

Addison Bed
Headboard 55" h
Footboard 24" h
#CADKB Cal King 75 7/8" w
#ADKB King 78 7/8" w
#ADQB Queen 62 7/8" w
#ADFB Full 56 7/8" w



Addison Panel Bed
Headboard 55" h
Footboard 24" h
#CADPKB Cal King 75 7/8" w
#ADPKB King 78 7/8" w
#ADPQB Queen 62 7/8" w
#ADPFB Full 56 7/8" w

* see underbed storage options
on line drawings page.

ADDISON

BEDROOM COLLECTION SPECIFICATIONS

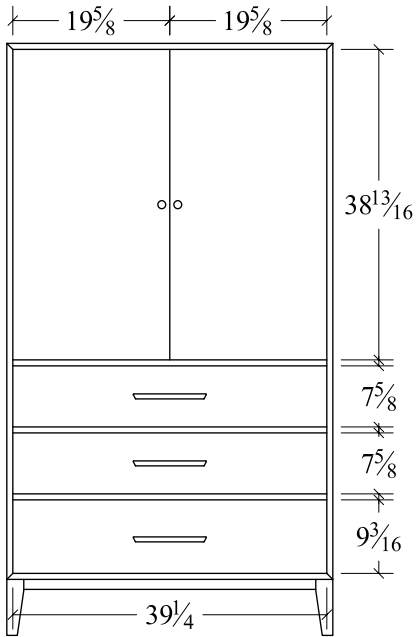

Armoire (ADAR)
3 drawer, 2 door
41w x 22d x 74 1/4h

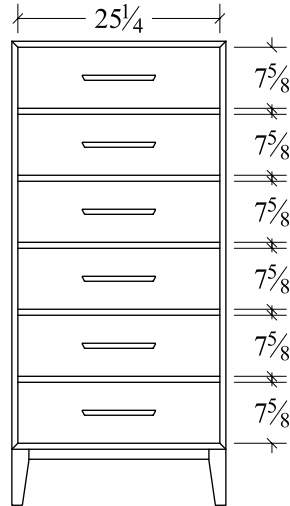

Lingerie (ADLC)
6 drawer
27w x 22d x 58 1/4h

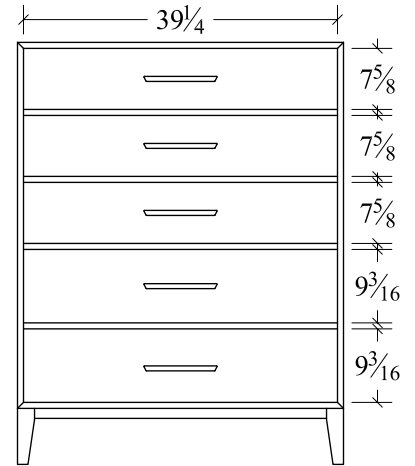

Chest (ADCD)
5 drawer
41w x 22d x 53 1/4h

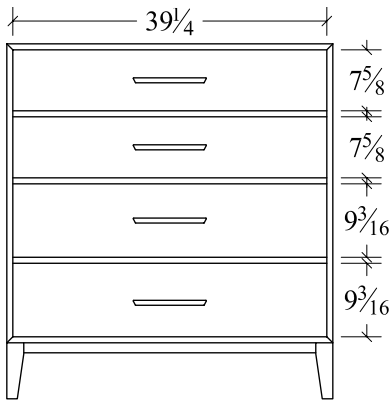

Chest (AD4CD)
4 drawer
41w x 22d x 44 5/8h

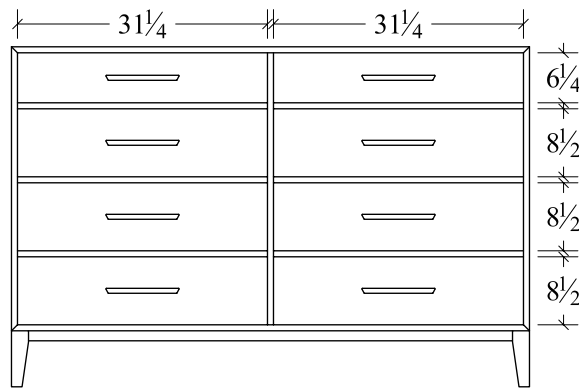

Dresser (AD8DR65)
8 drawer
65w x 22d x 43h

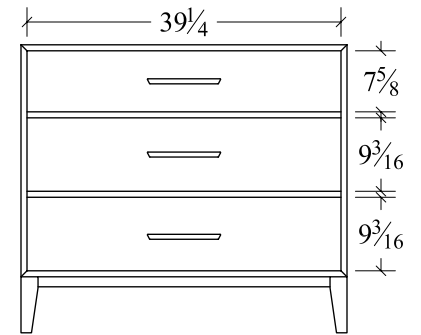

Chest (AD3CD)
3 drawer
41w x 22d x 36 1/4h

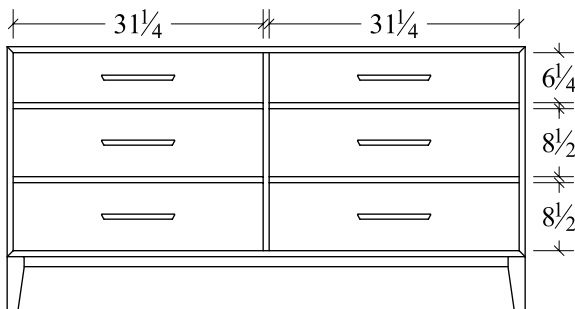

Dresser (ADDR)
6 drawer
65w x 22d x 33 1/2h

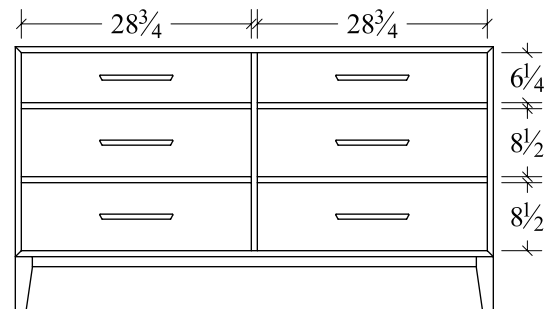

Dresser (AD6DR60)
6 drawer
60w x 22d x 33 1/2h

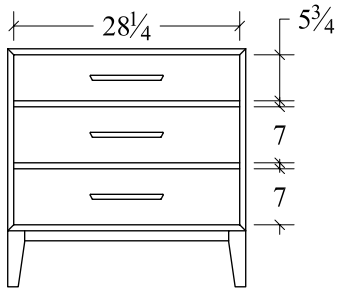

Night Stand (ADNS30)
3 drawer
30w x 18 3/4d x 30h

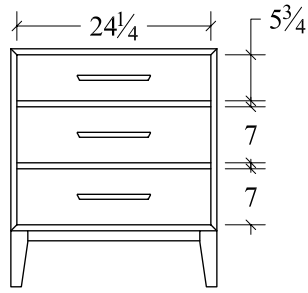

Night Stand (ADNS)
3 drawer
26w x 18 3/4d x 30h

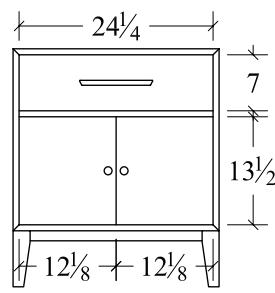

Night Stand (ADNS11)
1 drawer, 2 door
26w x 18 3/4d x 30h

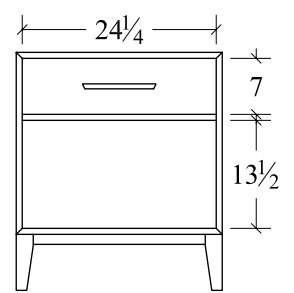

Night Stand (ADNS1)
1 drawer
26w x 18 3/4d x 30h

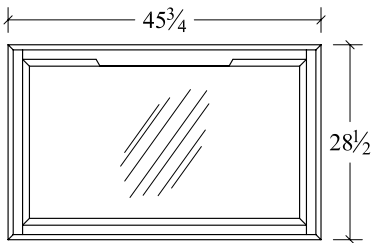

Mirror (ADMR8)
45 3/4w x 28 1/2h

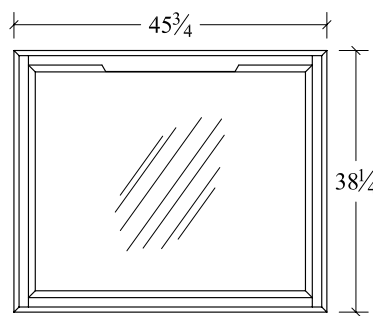

Mirror (ADMR)
45 3/4w x 38 1/4h

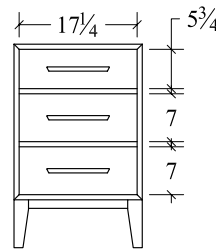

Night Stand (ADNS19)
3 drawer
16w x 18 3/4d x 30h

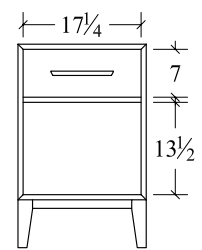

Night Stand (ADNS191)
1 drawer
19w x 18 3/4d x 30h

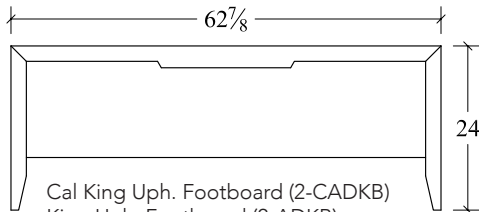

Cal King Uph. Footboard (2-CADKB)
King Uph. Footboard (2-ADKB)
Queen Uph. Footboard (2-ADQB)
Full Uph. Footboard (2-ADFB)
Twin Uph. Footboard (2-ADTB)

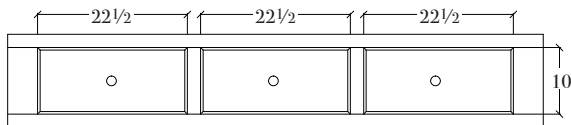

Storage Rail
3 drawer
14h
Cal King (3-2CADKBRS)
King (3-2ADKBRS)
Queen (3-2ADQBRS)
Full (3-2ADFBRS)
Twin (3-2ADTBRS)

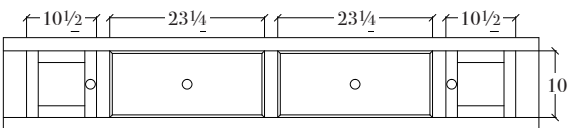

Storage Rail
2 door, 2 drawer
14h
See pricelist for underbed
storage order info

Cal King (3-CADKBRS)
King (3-ADKBRS)
Queen (3-ADQBRS)
Full (3-ADFBRS)
Twin (3-ADTBRS)

*Upholstered and Panel Bed are the same dimensions

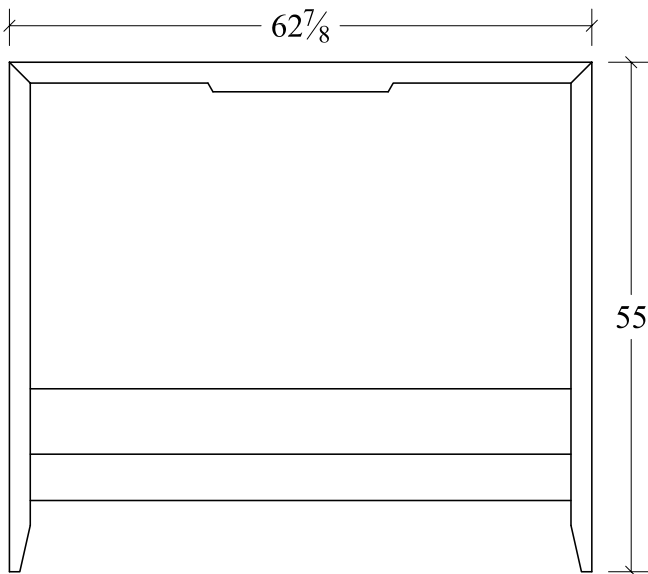

Cal King Uph. Headboard (1-CADKB)
King Uph. Headboard (1-ADKB)
Queen Uph. Headboard (1-ADQB)
Full Uph. Headboard (1-ADFB)
Twin Uph. Headboard (1-ADTB)

ADRIAN *Bedroom Collection*

COLLECTION FEATURES

- Bevel-cut mirror
- Mortise & tenon joints
- Dovetailed solid wood drawers
- Soft-close full extension drawers
- Solid wood fully framed case goods
- 1" thick solid tops
- Cast dovetail bracket mattress support
- Two solid hardwood adjustable shelves on armoire
- Cedar-lined bottom drawer on chest
- Dividers in second row drawers on dressers
- N-14 Black hardware
- Mission edge is standard

COLLECTION OPTIONS

- Hardware Options (see Features & Options page)
- Additional adjustable shelf for armoire (#AJS)
- Under bed storage unit
- Touch-switch LED night light (#LEDN)
- Night Stand available with sliding top, hidden compartment, lock & three-plug power strip (#STP)
- Armoire available with 1 hanger rod in place of 2 adjustable shelves
- Additional drawer dividers (#DD)
- Dresser drawer available with felt-lined jewelry tray (#SJT)
- Additional cedar-lined drawers (#CB)
- Docking drawer (#DKD)



Adrian 3-Drawer Nightstand
#ANNS
27" w x 17" d x 30 1/2" h



Shown in Brown Maple with #51 Autumn Finish



Adrian 6-Drawer Chest
#ANCD
40"w x 22"d x 53"h



Adrian Mirror
#ANMR
42"w x 2"d x 41"h

Adrian 7-Drawer Dresser
#AN7DR
66"w x 22"d x 36 1/2"h



Adrian Bed
Headboard 57"h
Footboard 30"h
#CANKB Cal King 79"w x 92"d,
#ANKB King 83"w x 88"d
#ANQB Queen 67"w x 88"d
#ANFB Full 61"w x 82"d

ALTERNATIVE BED SUGGESTION:
Fulton Bed
Headboard: 55"h
Footboard: 30"h
#CFLKB Cal. King: 81"w x 92 1/4"d
#FLKB King: 85"w x 88 1/4"d
#FLQB Queen: 69"w x 88 1/4"d
#FLFB Full: 63"w x 82 1/4"d



* see underbed storage options
on line drawings page.

ADRIAN

BEDROOM COLLECTION SPECIFICATIONS

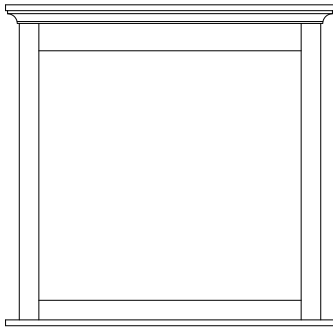

Mirror (ANM42)
42w x 41h

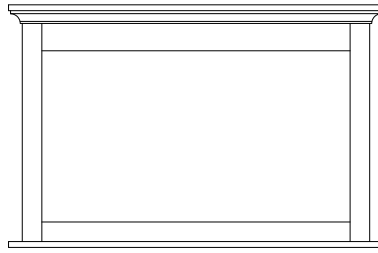

Mirror (ANM48)
48w x 31h

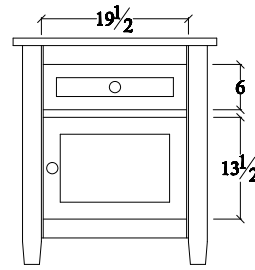

Nightstand (ANNS11R)
1 door, 1 drawer
27w x 17d x 30 1/2h

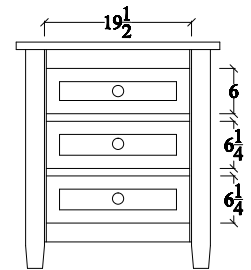

Nightstand (ANNS3)
3 drawer
27w x 17d x 30h

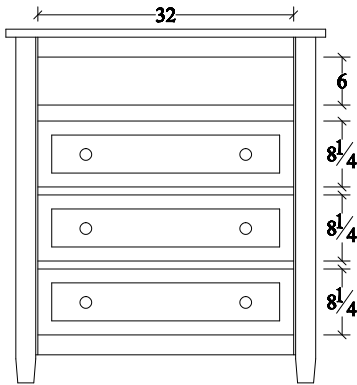

Media Chest (ANMC)
3 drawer, 1 opening
40w x 22d x 44 1/4h

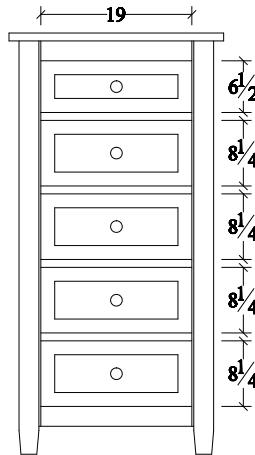

Lingerie Chest (ANLC)
5 drawer
27w x 17d x 53h

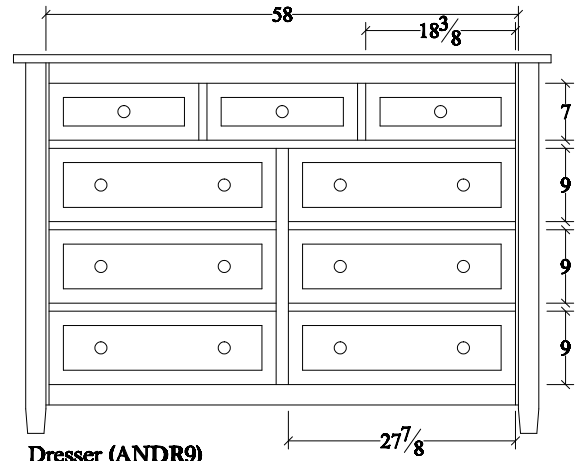

Dresser (ANDR9)
9 drawer
66w x 22d x 46 1/2 h

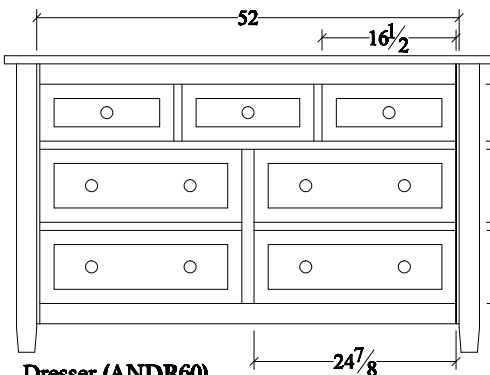

Dresser (ANDR60)
7 drawer
60w x 22d x 36 1/2 h

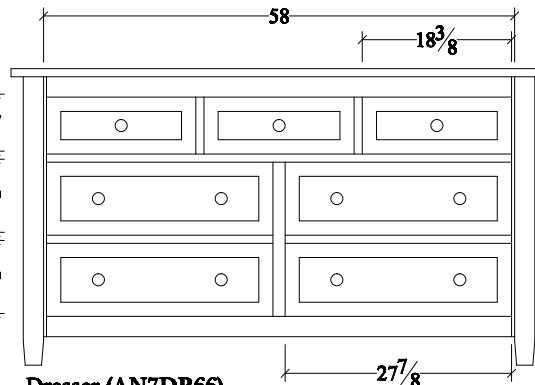

Dresser (AN7DR66)
7 drawer
66w x 22d x 36 1/2 h

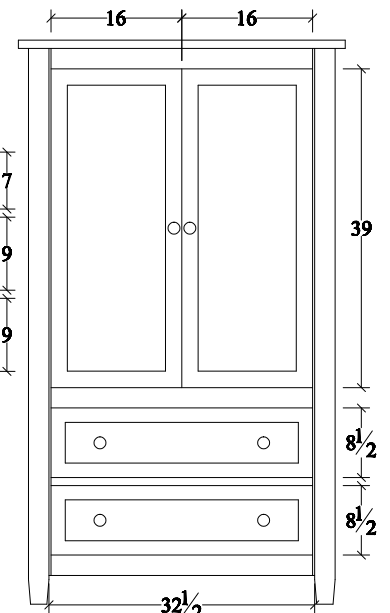

Armoire (ANAR)
2 door, 2 drawer
39w x 22d x 70h

*2 shelves

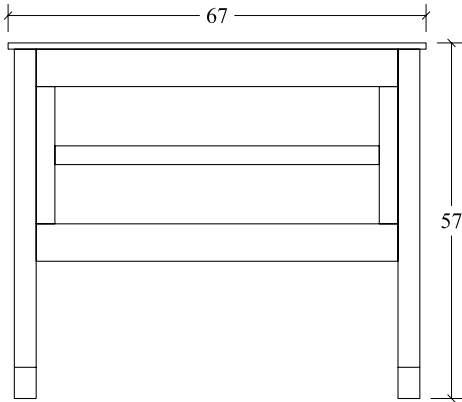

Queen Headboard (ANQB)
67w x 57h

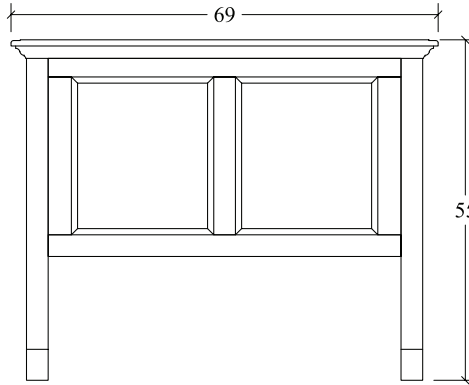

Queen Headboard (FLQB)
69w x 55h

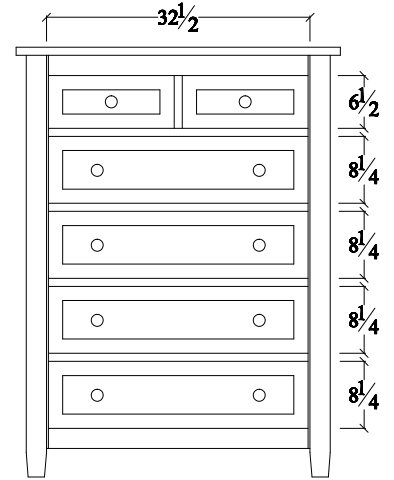

Chest (ANCD)
6 drawer
40w x 22d x 53h

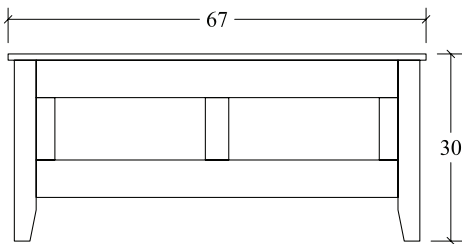

Queen Footboard (ANQB)
67w x 30h

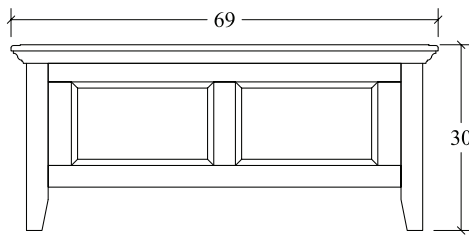

Queen Footboard (FLQB)
69w x 30h

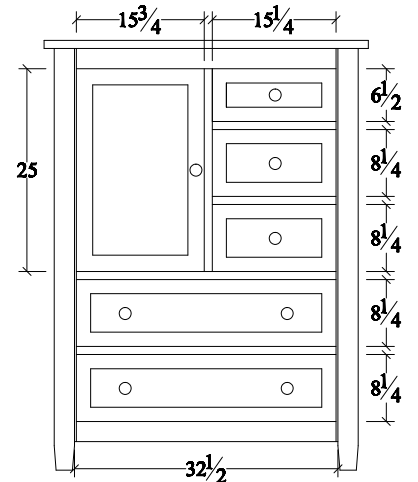

Door Chest (ANDRC)
1 door, 5 drawer
40w x 22d x 53h
*1 shelf

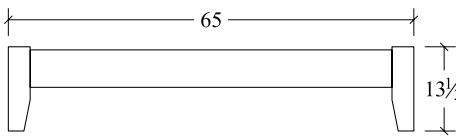

Queen Low Footboard (ANQB)
65w x 13 1/2h

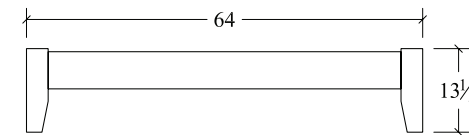

Queen Low Footboard (FLQB)
64w x 13 1/2h

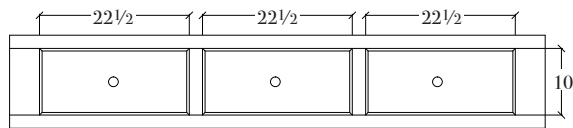

Storage Rail
3 drawer
14h
See pricelist for underbed
storage order info

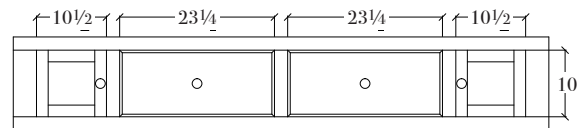

Storage Rail
2 door, 2 drawer
14h
See pricelist for underbed
storage order info

BUNGALOW *Bedroom Collection*

COLLECTION FEATURES

- Mirrors have bevel cut edges
- Constructed with mortise and tenon joints
- Dovetailed, solid Cedar wood drawers
- Soft-closing, full extension, undermount drawer guides
- Measurements are to the tops of the backsplash on the case goods

COLLECTION OPTIONS

- Low footboard option
- Distressed finish (#2D)
- Hardware options (see Features & Options page)
- Underbed storage options

NOTE: This collection not available with nightlight or docking station options

**Bungalow cannot have sliding top option*

Inspired by the traditions of Mission style, the clean, vertical lines and flat planes of the timeless Bungalow Collection are crafted from red, quarter-sawn oak, with a finish that uses the natural grain of the wood as a decorative element. Highlights include cedar drawer boxes with English dovetail construction, handsome hardware in a rustic finish, and a spindle bed and nightstand that impart a light and airy look crafted to last for generations. Coordinating upholstered furniture is also available.



Bungalow 1-Drawer Nightstand
#13-1601
21" w x 20" d x 31" h



Shown in Quartersawn Oak with #32 Michaels finish

Bungalow Panel Bed

Popular Sizes:

- Twin Panel Bed
#13-1502T 46" x 48"
- Full Panel Bed
#13-1502F 64" x 48"
- Queen Panel Bed
#13-1502Q 72" x 48"
- King Panel Bed
#13-1502K 92" x 48"
- Cal King Panel Bed
#13-1502C 84" x 48"



Bungalow Panel Bed w/ Low Footboard

Popular Sizes:

- Twin Panel Bed
#13-1502TLF 46" x 48"
- Full Panel Bed
#13-1502FLF 64" x 48"
- Queen Panel Bed
#13-1502QLF 72" x 48"
- King Panel Bed
#13-1502KLF 92" x 48"
- Cal King Panel Bed
#13-1502CLF 84" x 48"

Bungalow Spindle Bed

Popular Sizes:

- Twin Spindle Bed
#13-1501T 46" x 48"
- Full Spindle Bed
#13-1501F 64" x 48"
- Queen Spindle Bed
#13-1501Q 70" x 48"
- King Spindle Bed
#13-1501K 86" x 48"
- Cal King Spindle Bed
#13-1501C 82" x 48"



Bungalow Spindle Bed w/ Low Footboard

Popular Sizes:

- Twin Spindle Bed
#13-1501TLF 46" x 48"
- Full Spindle Bed
#13-1501FLF 64" x 48"
- Queen Spindle Bed
#13-1501QLF 70" x 48"
- King Spindle Bed
#13-1501KLF 86" x 48"
- Cal King Spindle Bed
#13-1501CLF 82" x 48"

* see underbed storage options on line drawings page.

BUNGALOW *Bedroom Collection*

CONTINUED...



Pull-Out Tray

Bungalow 3 Drawer Nightstand
#13-1602
24"w x 20 1/2"d x 31"h

Pull-Out Tray



Bungalow 3 Drawer Chest
#13-1801
34"w x 20 1/2"d x 33"h



Bungalow 9 Drawer Mule Chest
#13-1804
67"w x 20 1/2"d x 38"h



Solid Cedar Drawer Boxes

Bungalow 7 Drawer Dresser
#13-1701
65"w x 20 1/2"d x 35 1/2"h





Bungalow Gentleman's Chest
 #13-1805
 41" w x 20 1/2" d x 54" h

*1 adjustable shelf behind door



Bungalow 8 Drawer Chest
 #13-1802
 41" w x 20 1/2" d x 54" h



Bungalow Mule Mirror
 #13-2002
 61" w x 29" h

Bungalow Mule Chest
 #13-1803
 67" w x 20 1/2" d x 46 1/2" h

BUNGALOW

BEDROOM COLLECTION SPECIFICATIONS

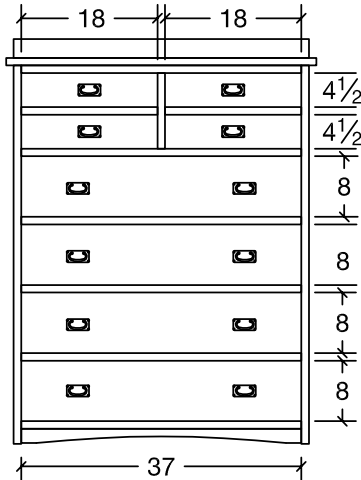

13-1802
8 Drawer Chest
8 Drawers
41w x 20 1/2d x 54h

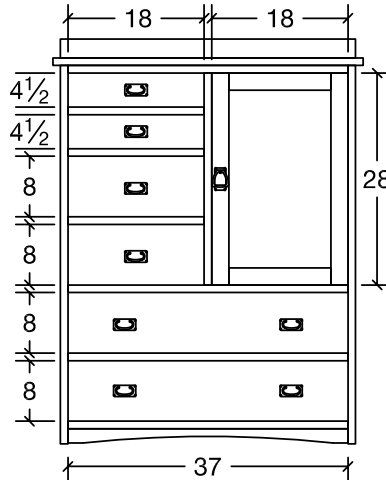

13-1805
Gentlemans Chest
6 Drawers, 1 Door
41w x 20 1/2d x 54h

*1 adjustable shelf behind door

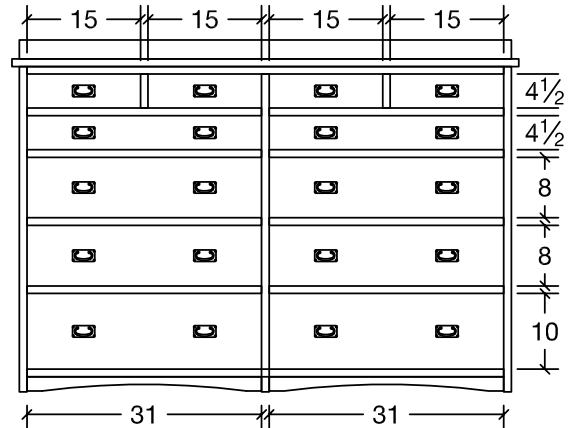

13-1803
Mule Chest
12 Drawers
67w x 20 1/2d x 46 1/2h

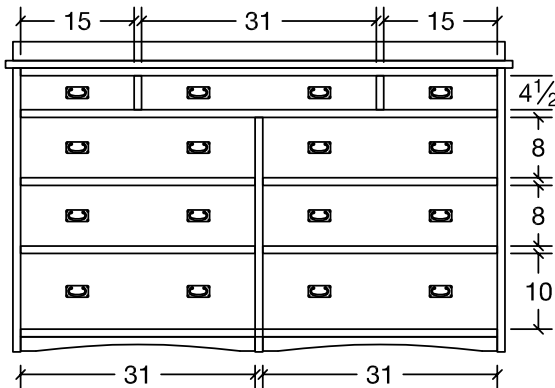

13-1804
9 Drawer Mule Chest
9 Drawers
67w x 20 1/2d x 38h

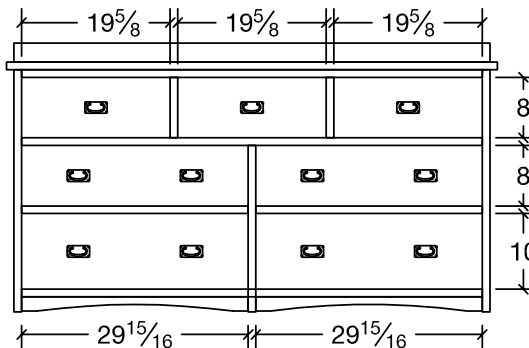

13-1701
7 Drawer Dresser
7 Drawers
65w x 20 1/2d x 35 1/2h

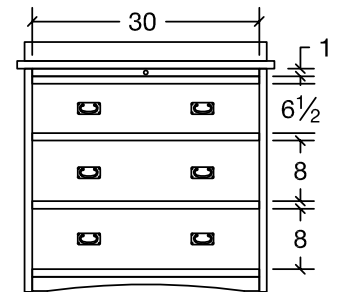

13-1801
3 Drawer Chest
3 Drawers
34w x 20 1/2d x 33h

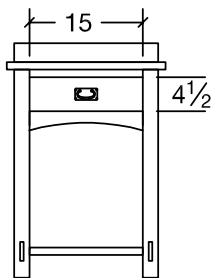

13-1601
1 Drawer Nightstand
1 Drawer
21w x 20d x 31h

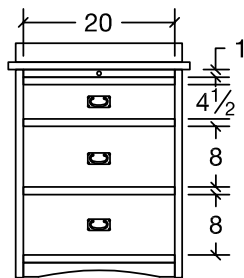

13-1602
3 Drawer Nightstand
3 Drawers
24w x 20 1/2d x 31h

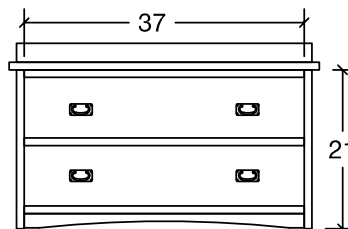

13-2101
Lift Top Blanket Chest
No Drawers
41w x 20 1/2d x 24 1/2h

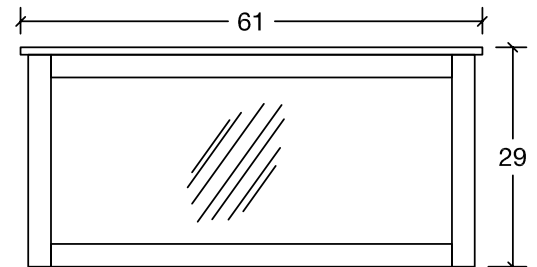

13-2002
Mule Mirror
61w x 29h

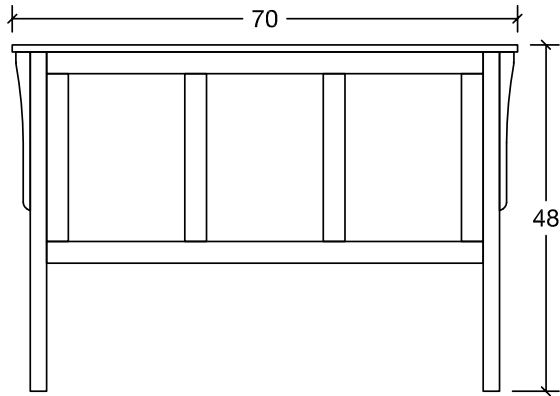

1-13-1502F
Queen Panel Headboard
70w x 48h

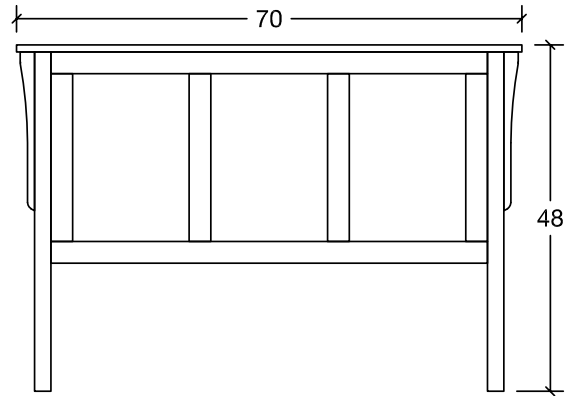

1-13-1502F
Queen Panel Headboard
70w x 48h

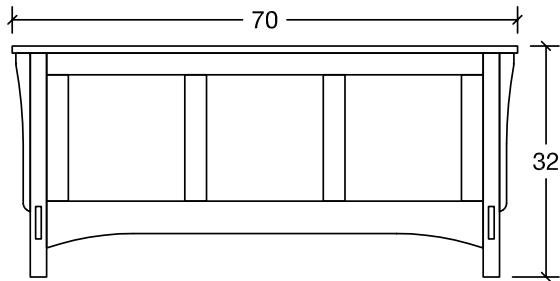

2-13-1502Q
Queen Panel Footboard
70w x 32h

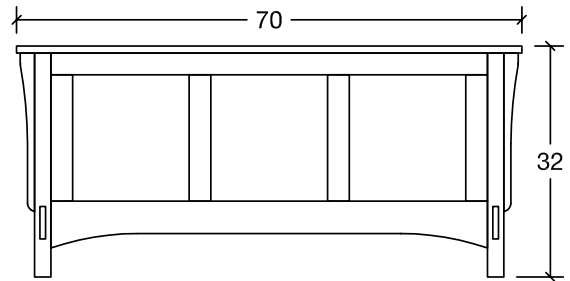

2-13-1502Q
Queen Panel Footboard
70w x 32h

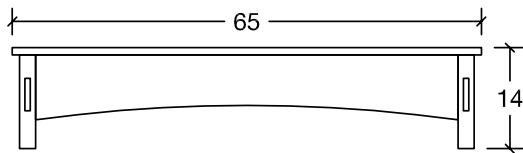

2-13-1502QLFB
Queen Panel
Low Footboard
65w x 14h

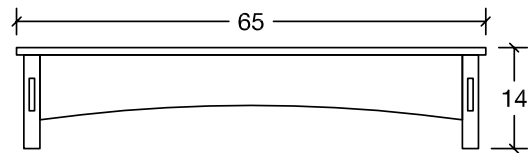

2-13-1502QLFB
Queen Panel
Low Footboard
65w x 14h

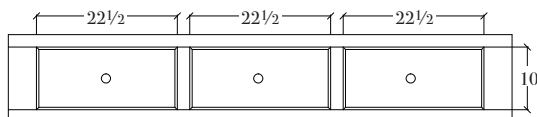

Storage Rail
3 drawer
14h
See pricelist for underbed
storage order info

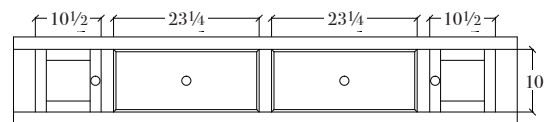

Storage Rail
2 door, 2 drawer
14h
See pricelist for underbed
storage order info

CASTLEBROOK *Bedroom Collection*

COLLECTION FEATURES

- Bevel-cut mirror
- Mortise & tenon joints
- Dovetailed solid wood drawers
- Soft-close full extension drawers
- Solid wood fully framed case goods
- 1 1/4" thick solid tops
- Decorative through tenons
- Yellowheart wood inlays
- W-1 & W-2 hardware is standard
- Mission edge is standard

COLLECTION OPTIONS

- Hardware Options
(see Features & Options page)
- Docking drawer (#DKD)

Castlebrook 1-Drawer Night Stand #CANS1

25"w x 18 1/2"d x 30 1/4"h



Castlebrook 3-Drawer Night Stand #CANS3

25"w x 18 1/2"d x 30 1/4"h



Inlays are standard

Castlebrook Panel Bed

- Headboard 56 1/4"h
- Footboard 31 1/4"h
- #CCAKB Cal King 81 1/4"w x 91 1/2"d
- #CAKB King 85 1/4"w x 87 1/2"d
- #CAQB Queen 69 1/4"w x 87 1/2"d
- #CAFB Full 63 1/4"w x 82"d
- #CATB Twin 50 1/4"w x 82"d



* see underbed storage options
on line drawings page.



**Castlebrook
6 Drawer Chest**
#CACD
41" w x 22" d x 53 1/4" h

**Castlebrook
32" Mirror**
#CAMR32
51" w x 2 1/2" d x 32" h



**Castlebrook
9-Drawer Dresser**
#CA9DR
65" w x 22" d x 43" h



Castlebrook His & Hers Chest
7 Drawer, 2 Door
#CAHHC
53" w x 22" d x 50 1/2" h

*1 shelf behind each door

Castlebrook 40" Mirror
#CAMR40
51" w x 2 1/2" d x 40 1/2" h

Castlebrook 7-Drawer Dresser
#CA7DR
65" w x 22" d x 33 1/4" h



CASTLEBROOK

BEDROOM COLLECTION SPECIFICATIONS

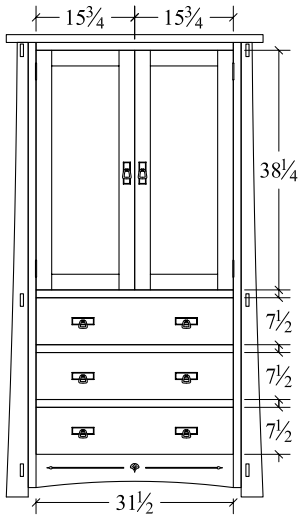

Armoire (CAAR)
3 drawer, 2 door
41w x 22d x 74h
*2 shelves

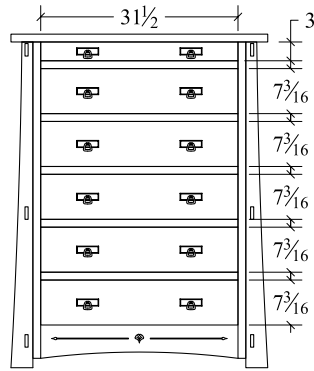

Chest (CACD)
6 drawer
41w x 22d x 53 1/4h

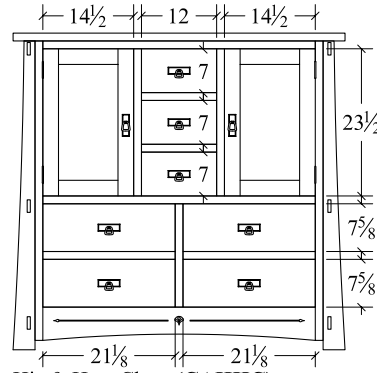

His & Hers Chest (CAHHC)
7 drawer, 2 door
53w x 22d x 50 1/2h
*1 shelf behind each door

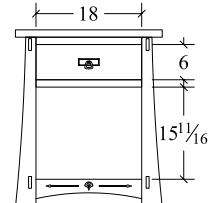

Night Stand (CANS1)
1 drawer, 1 opening
25w x 18 1/2d x 30 1/4h

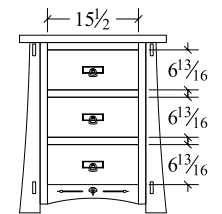

Night Stand (CANS3)
3 drawer
25w x 18 1/2d x 30 1/4h

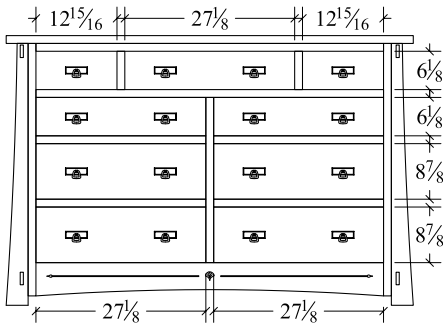

Dresser (CA9DR)
9 drawer
65w x 22d x 43h

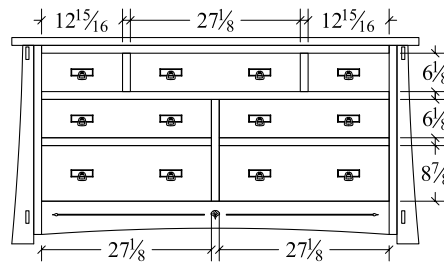

Dresser (CA7DR)
7 drawer
65w x 22d x 33 1/4h

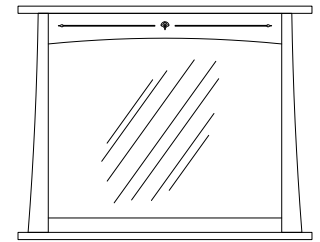

Mirror (CAMR40)
51w x 40 1/2h

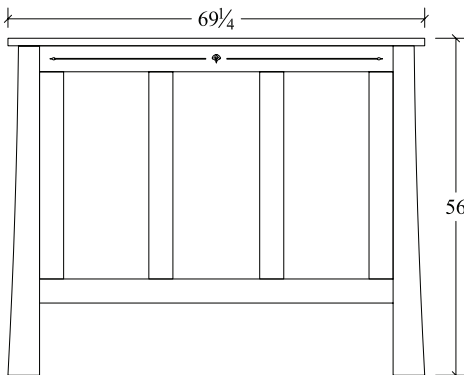

Queen Headboard (MS-PB-Q)
69 1/4w x 56h

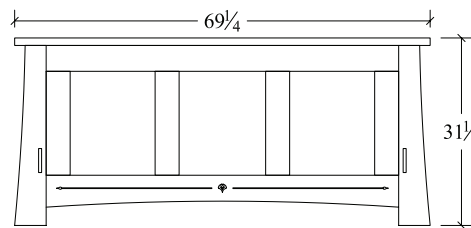

Queen Footboard (MS-PB-Q)
69 1/4w x 31 1/4h

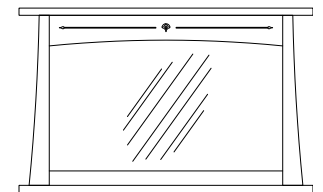

Mirror (CAMR32)
51w x 32h

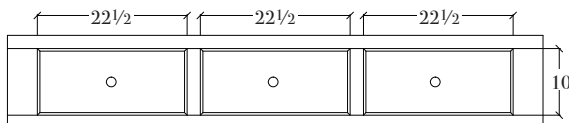

Storage Rail
3 drawer
14h

See pricelist for underbed storage order info

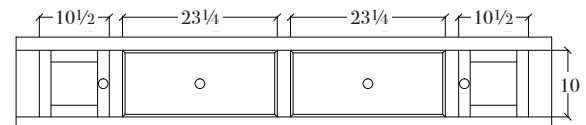

Storage Rail
2 door, 2 drawer
14h

See pricelist for underbed storage order info

CEDAR LAKES *Bedroom Collection*

COLLECTION FEATURES

- Iron Bolt Detail
- Mirrors have bevel cut edges
- Constructed with mortise and tenon joints
- Cast dovetailed brackets support mattress
- Dovetailed solid wood drawers
- Soft-closing full extension undermount drawer guides
- Chest features a cedar lined drawer bottom
- Dresser features dividers in second row drawers
- A-5 pulls and A-6 Knobs
- Bolts in corners will always be black, no other color options

COLLECTION OPTIONS

- Distressed Finish (#2D)
- Hardware Options
(see Features & Options page)
- Underbed Storage Options
- LED nightlight (#LEDN)
- Docking drawer with power (#DKD)
- Additional drawer dividers for dressers (#DD)
- Dresser drawer available with felt lined jewelry tray (#SJT)
- Additional cedar lined drawers available (#CB)



**Cedar Lakes
1-Drawer Night Stand**
#CLNS1
26" w x 16 1/2" d x 30" h



Shown in Oak with #100 Pebble Finish



**Cedar Lakes
60" Dresser Mirror**
#CLMR
42"w x 38 1/2"h

**Cedar Lakes
6 Drawer Chest**
#CLCD
38"w x 19"d x 53"h



**Cedar Lakes
60" Dresser**
#CLDR60
60"w x 19"d x 38"h



Cedar Lakes Bed
Headboard 60"h
Footboard 18"h
#CCLCKB Cal. King Bed 77 1/2"w x 90"d
#CLKB King Bed 81 1/2"w x 86"d
#CLQB Queen Bed 65 1/2"w x 86"d
#CLFB Full Bed 59 1/2"w x 80"d
#CLTB Twin Bed 44 1/2"w x 80"d

* see underbed storage options
on line drawings page.

CEDAR LAKES

BEDROOM COLLECTION SPECIFICATIONS

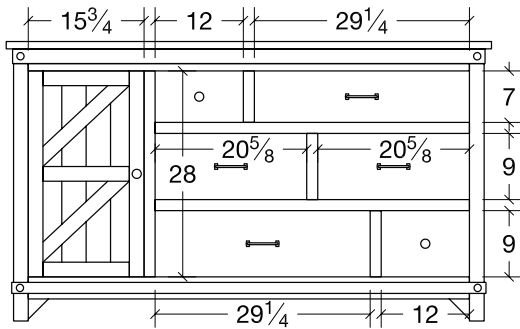

Door Dresser (CLDDR)

6 drawer, 1 door
66w x 19d x 38h

*1 shelf behind door

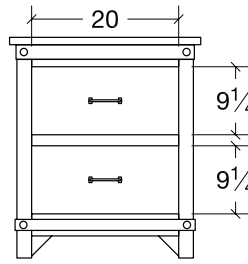

Night Chest (CLNS2)

2 drawer
26w x 16 1/2d x 30h

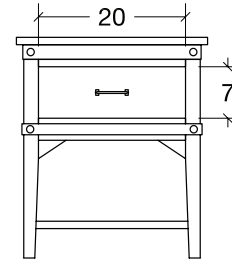

Night Table (CLNS1)

1 drawer, 1 Shelf
26w x 16 1/2d x 30h

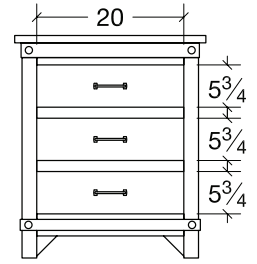

Night Stand (CLNS3)

3 drawer
26w x 16 1/2d x 30h

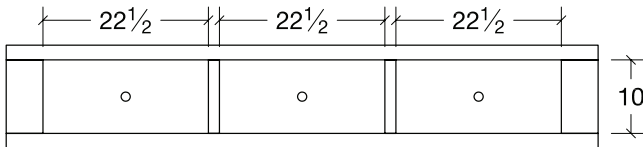

Storage Rail, King and Queen

3 drawer
80 1/2w x 14h

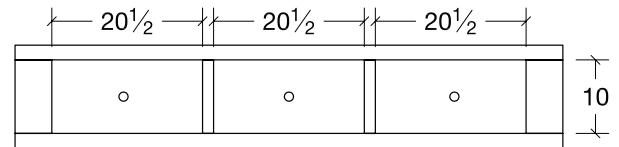

Storage Rail, Full

3 drawer
74 1/2w x 14h

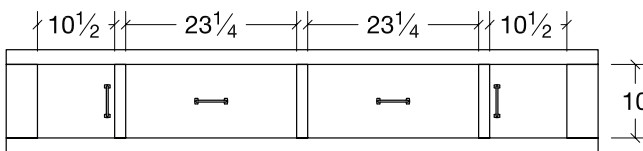

Storage Rail, King and Queen

2 drawer, 2 door
80 1/2w x 14h

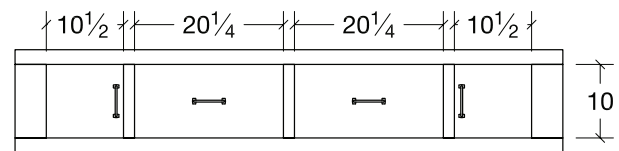

Storage Rail, Full

2 drawer, 2 door
74 1/2w x 14h

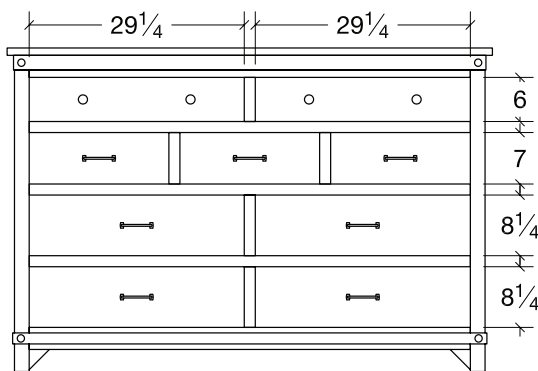

Tall Dresser (CL9DR)

9 drawer
66w x 19d x 44h

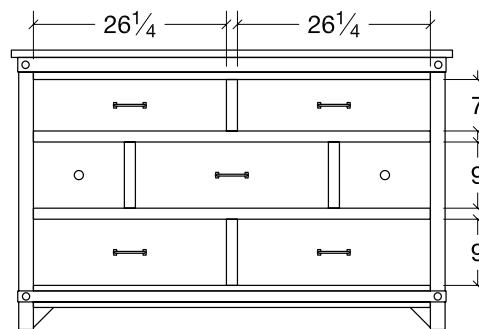

Dresser (CLDR60)

7 drawer
60w x 19d x 38h

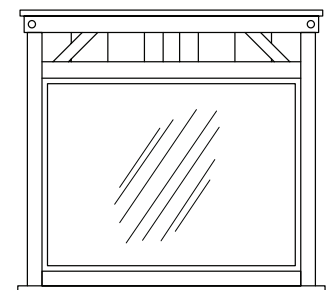

Dresser Mirror (CLMR)

42w x 38 1/2h

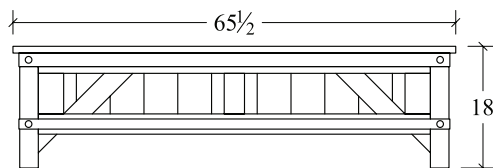

Queen Footboard (CLQB)

65 1/2w x 30h

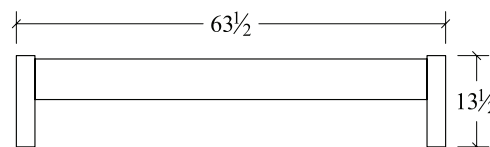

Queen Low Footboard (CLQB)

63 1/2w x 13 1/2h

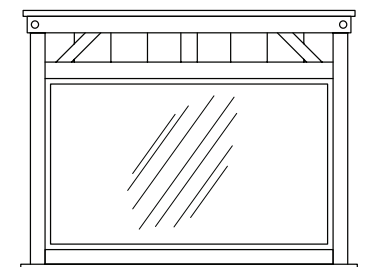

Dresser Mirror (CLMR 46)

46w x 35 1/2h

CEDAR LAKES

BEDROOM COLLECTION SPECIFICATIONS

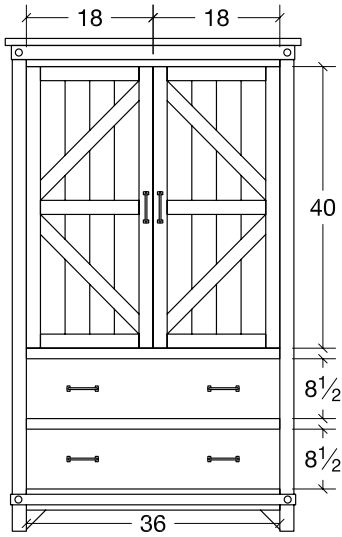

Armoire (CLAR)
2 drawer, 2 door
42w x 22d x 70h
*2 shelves

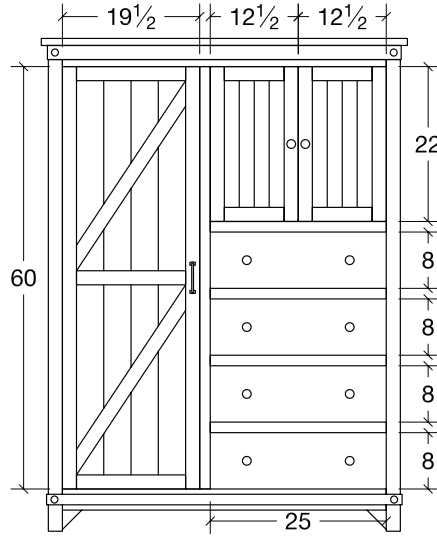

Chifferobe (CLCB)
4 drawer, 3 door
52w x 22d x 70h
*3 shelves and 1 rod behind long door
*1 shelf behind small doors

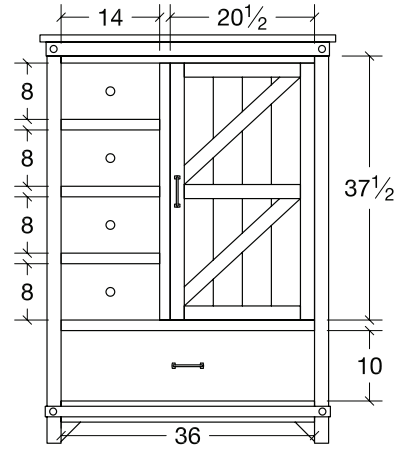

Door Chest (CLDRC)
5 drawer, 1 door
42w x 19d x 58h
*2 shelves

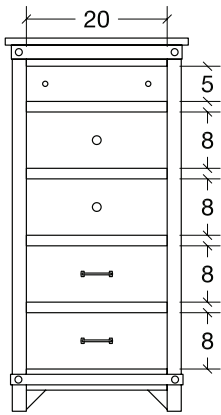

Lingerie Chest (CLLC)
5 drawer
26w x 16 1/2d x 53h

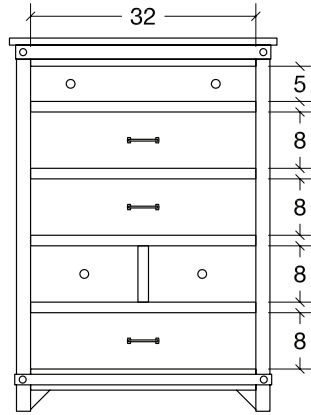

Drawer Chest (CLCD)
6 drawer
38w x 19d x 53h

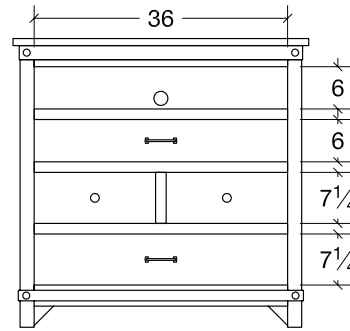

Media Chest (CLMC)
4 drawer
42w x 19d x 41h

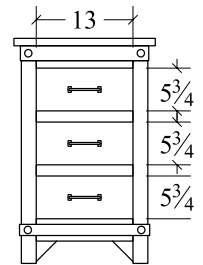

Night Stand (CLNS319)
3 drawer
19w x 16 1/2d x 30h

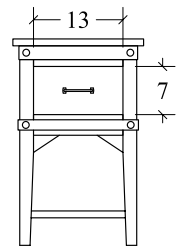

Night Table (CLNS119)
1 drawer, 1 Shelf
19w x 16 1/2d x 30h

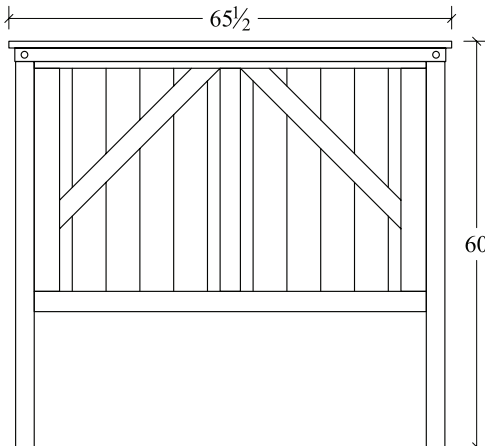

Queen Headboard (CLQB)
65 1/2w x 60h

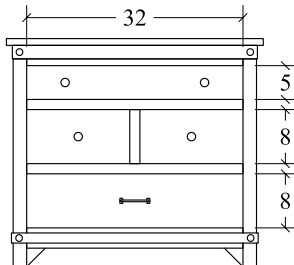

Drawer Chest (CLCD4)
4 drawer
38w x 19d x 34h

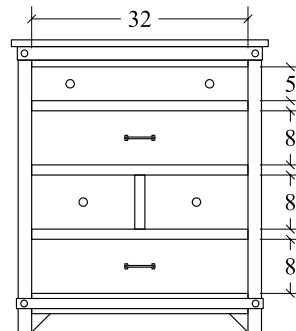

Drawer Chest (CLCD5)
5 drawer
38w x 19d x 43 1/2h

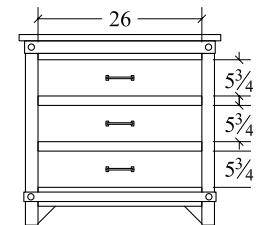

Night Stand (CLNS332)
3 drawer
32w x 16 1/2d x 30h



DELRIDGE *Bedroom Collection*

COLLECTION FEATURES

- Saw Marks & Grooved Panels
- Mirrors have bevel cut edges
- Constructed with mortise and tenon joints
- Cast dovetailed brackets support mattress
- Dovetailed solid wood drawers
- Soft-closing full extension undermount drawer guides
- Chest features a cedar lined drawer bottom
- Dresser features dividers in second row drawers
- Pewter Hardware, not available on other collections

COLLECTION OPTIONS

- Distressed Finish (#2D)
- Hardware Options (see Features & Options page)
- Underbed Storage Options
- LED nightlight (#LEDN)
- Docking drawer with power (#DKD)
- Additional drawer dividers for dressers (#DD)
- Dresser drawer available with felt lined jewelry tray (#SJT)
- Additional cedar lined drawers available (#CB)

**Delridge cannot have sliding top option*

- Collection is available in all finishes however it is recommended in either New Century or Rustic Bourbon finish due to rustic detail.

**Hardware not available on other collections*

Delridge 3 Drawer Nightstand
#DENS3
26" w x 16 1/2" d x 29" h



Brown Maple with #103 Dew distressed finish



**Delridge
His & Hers Chest**
#DEHHC
48"w x 19"d x 64 1/4"h
*2 shelves behind doors



**Delridge
60\"/>A wooden dresser with six drawers arranged in two rows of three. The top row has two smaller drawers and one larger one. The bottom row has two larger drawers and one smaller one. The wood has a dark stain and a prominent grain. It stands on four short, dark legs.**

Delridge 60\"/>A wooden bed frame with a headboard and footboard. The headboard is tall and features a large, rectangular panel with a wood grain pattern. The footboard is shorter and also features a wood grain panel. The bed is shown with a white sheet and two white pillows. It stands on four short, dark legs.

Delridge Bed
Headboard 58"h
Footboard 20"h
#DECKB Cal. King Bed 76"w x 89 1/2"d
#DEKB King Bed 80"w x 85 1/2"d
#DEQB Queen Bed 64"w x 85 1/2"d
#DEFB Full Bed 58"w x 79 1/2"d
#DETB Twin Bed 43"w x 79 1/2"d

* see underbed storage options
on line drawings page.

DELRIDGE

BEDROOM COLLECTION SPECIFICATIONS

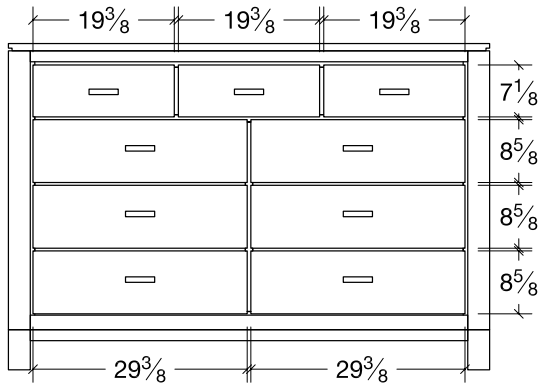

Dresser (DEDR9)
9 drawer
66w x 19d x 45h

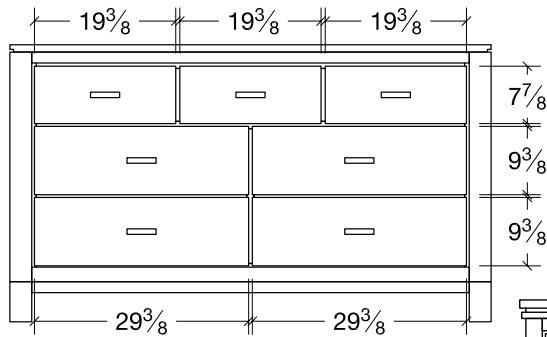

Dresser (DE7DR66)
7 drawer
66w x 19d x 38h

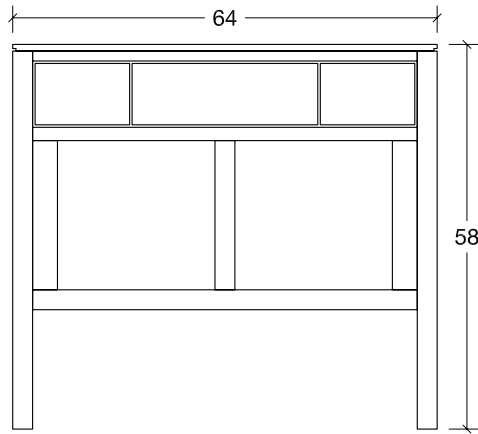

Queen Headboard (DEQB)
64w x 58h

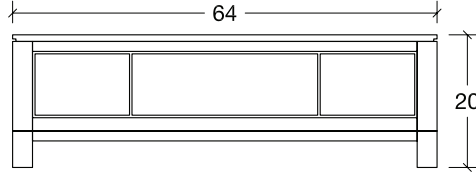

Queen Footboard (DEQB)
64w x 20h

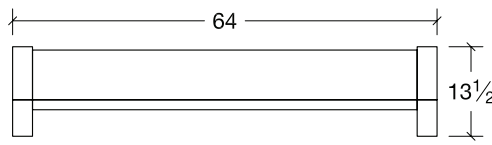

Queen Low Footboard (DEQB)
64w x 13 1/2h

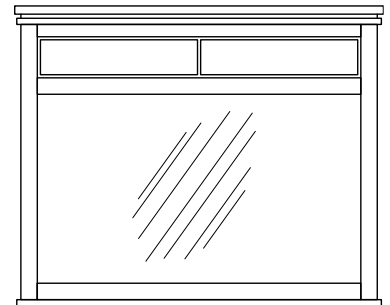

Mirror (DEMR 45)
45w x 36 1/2h

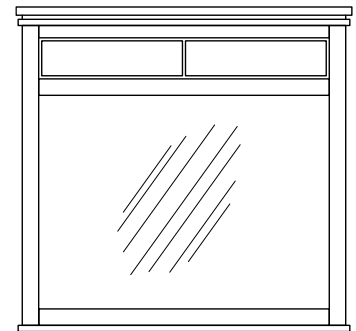

Mirror (DEMR)
41w x 39 1/2h

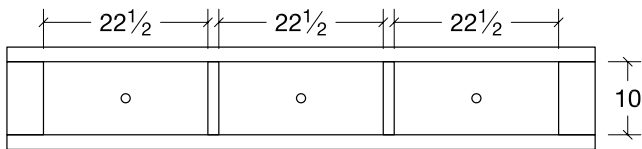

Storage Rail, King and Queen
3 drawer
80 1/2w x 14h

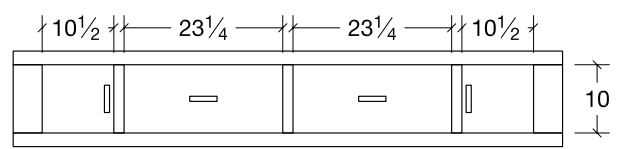

Storage Rail, King and Queen
2 drawer, 2 door
80 1/2w x 14h

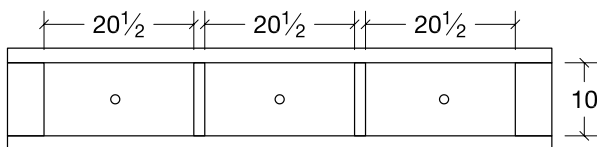

Storage Rail, Full
3 drawer
74 1/2w x 14h

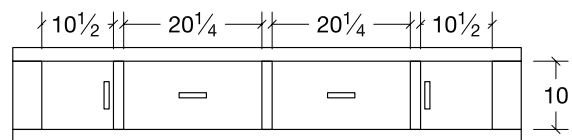

Storage Rail, Full
2 drawer, 2 door
74 1/2w x 14h

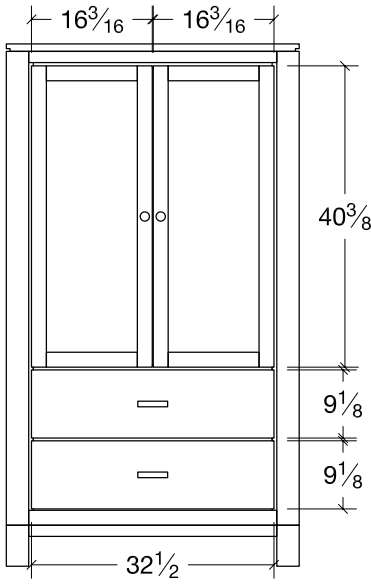

Armoire (DEAR) *2 shelves
2 drawer, 2 door
39 1/4w x 21 1/2d x 70h

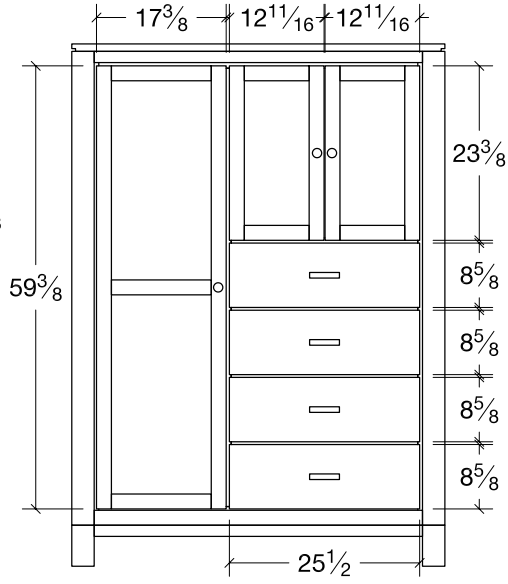

Chifferobe (DEBC) *1 shelf behind small doors
*3 shelves and 1 rod behind long door
4 drawer, 3 door
50w x 21 1/2d x 70h

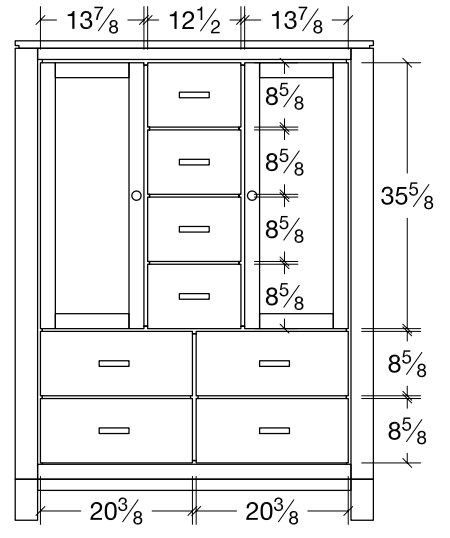

His - Hers Chest (DEHHC) *2 shelves behind doors
8 drawer, 2 door
48w x 19d x 64 1/4h

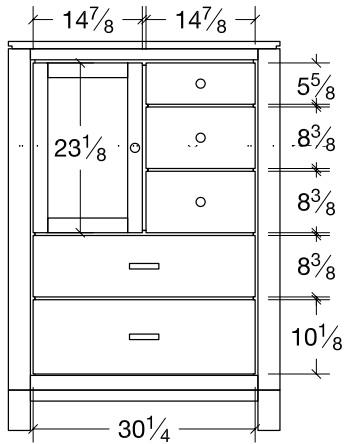

Door Chest (DEDRC) *1 shelf
5 drawer, 1 door
37w x 19d x 53h

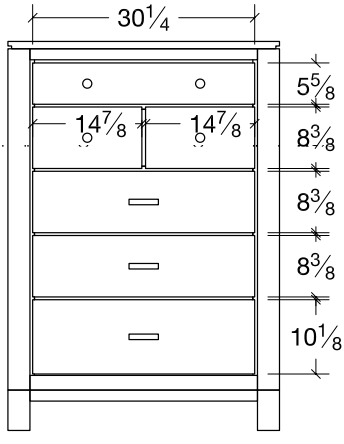

Chest (DECD)
6 drawer
37w x 19d x 53h

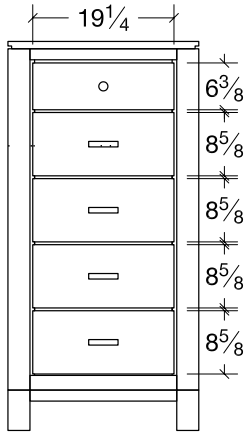

Lingerie Chest (DEL)
5 drawer
26w x 16 1/2d x 53h

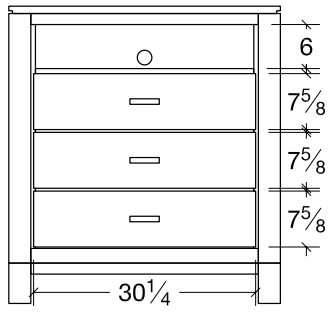

Media Chest (DEMC)
3 drawer
37w x 19d x 40 1/2h

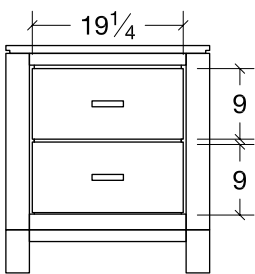

Night Stand (DENS2)
2 drawer
26w x 16 1/2d x 29h

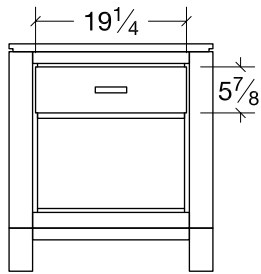

Night Stand (DENS1)
1 drawer
26w x 16 1/2d x 29h

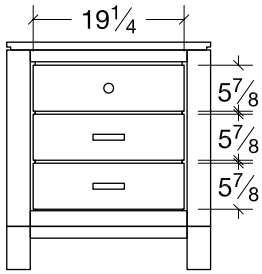

Night Stand (DENS3)
3 drawer
26w x 16 1/2d x 29h

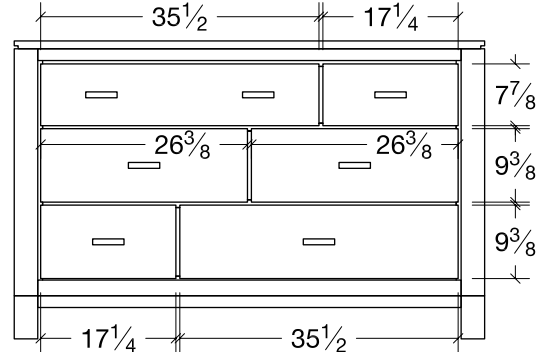

Dresser (DEDR)
6 drawer
60w x 19d x 38h

EMMA *Bedroom Collection*

COLLECTION FEATURES

- Constructed with mortise and tenon joints
- Cast dovetailed brackets support mattress
- Dovetailed, solid wood drawers
- Full extension, side mounted, ball-bearing guides
- Hardware not available on other collections

COLLECTION OPTIONS

- Hardware options (see Features & Options page)
- Underbed storage available



- knob : 1586 FB
- pull : 53019 FB



Emma
3-Drawer Nightstand
#EANS3
23" w x 17" d x 28 1/2" h



Shown in Oak with #116 Cider finish

Emma 6 Drawer Chest
#EACD
37" w x 21 1/2" d x 51 1/2" h



Emma Mirror
#EAMR
37 5/8" w x 33 5/8" h

**Emma
7-Drawer Dresser**
#EADR
60" w x 21 1/2" d x 36 1/2" h

Emma Bed
Headboard 54" h
Footboard 19" h
#CEAKB Cal. King Bed 78" w
#EAKB King Bed 82" w
#EAQB Queen Bed 66" w
#EAFB Full Bed 60" w
#EATB Twin Bed 45" w



* see underbed storage options
on line drawings page.

EMMA

BEDROOM COLLECTION SPECIFICATIONS

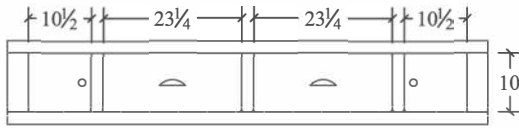

Storage Rail (EARS)
2 drawer, 2 door
80 1/2w x 14h

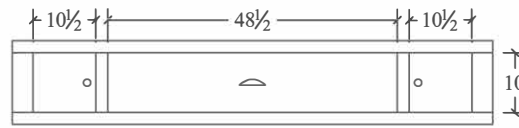

Storage Rail (EARS1)
1 drawer, 2 door
80 1/2w x 14h

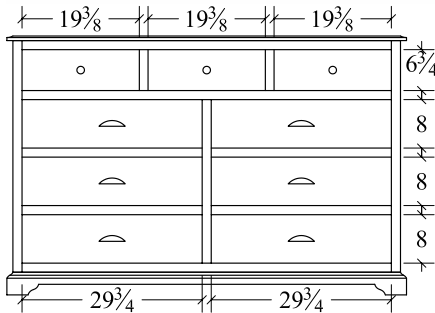

Dresser (EADR9)
9 drawer
66w x 21 1/2d x 42 3/4h

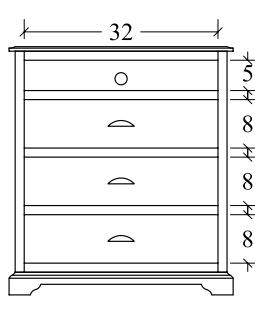

Media Chest (EAMC)
3 drawer, 1 opening
37w x 21 1/2d x 41h

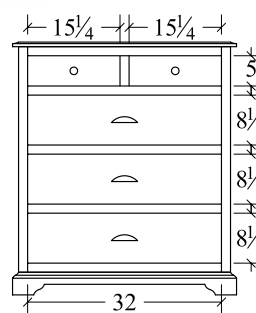

Chest (EACD5)
5 drawer
37w x 21 1/2d x 41 3/4h

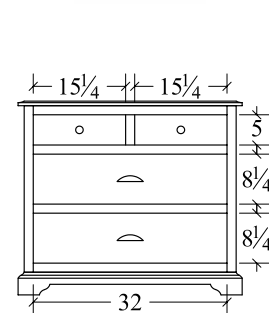

Chest (EACD4)
4 drawer
37w x 21 1/2d x 32h

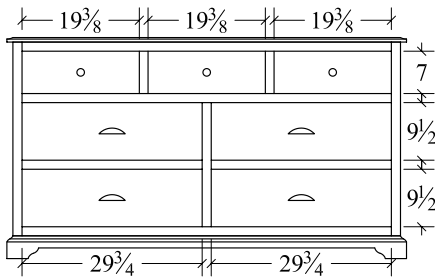

Dresser (EADR66)
7 drawer
66w x 21 1/2d x 36 1/2h

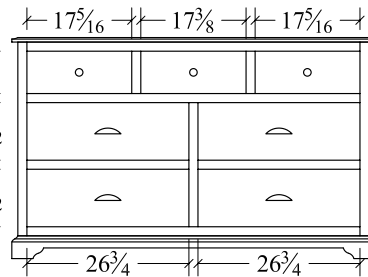

Dresser (EADR)
7 drawer
60w x 21 1/2d x 36 1/2h

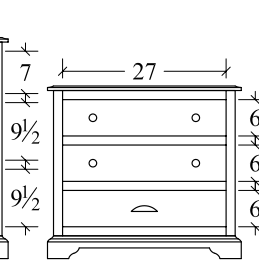

Night Stand (EANS332)
3 drawer
32w x 17d x 28 1/2h

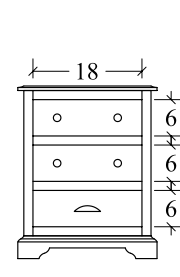

Night Stand (EANS3)
3 drawer
23w x 17d x 28 1/2h

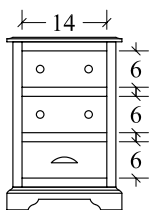

Night Stand (EANS319)
3 drawer
19w x 17d x 28 1/2h

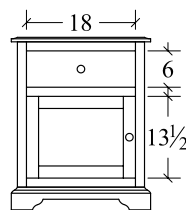

Night Stand (EANS11L)
1 drawer, 1 door
23w x 17d x 28 1/2h

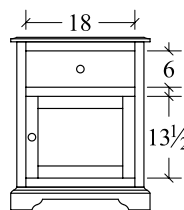

Night Stand (EANS11R)
1 drawer, 1 door
23w x 17d x 28 1/2h

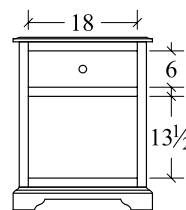

Night Stand (EANS1)
1 drawer
23w x 17d x 28 1/2h

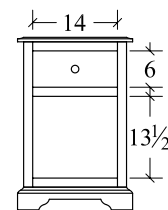

Night Stand (EANS119)
1 drawer
19w x 17d x 28 1/2h

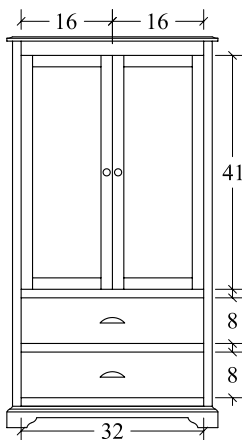

Armoire (EAAR)
2 drawer, 2 door
37w x 21 1/2d x 68 1/2h

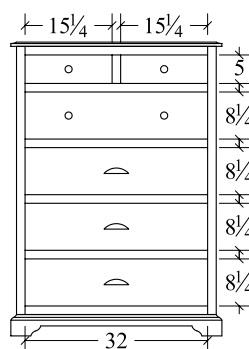

Chest (EACD)
6 drawer
37w x 21 1/2d x 51 1/2h

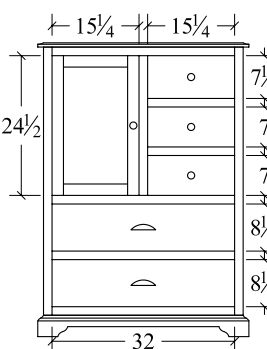

Door Chest (EADRC)
5 drawer, 1 door
37w x 21 1/2d x 51 1/2h

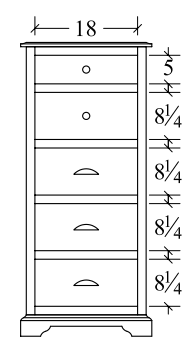

Lingerie Chest (EALC)
5 drawer
23w x 17d x 51 1/2h

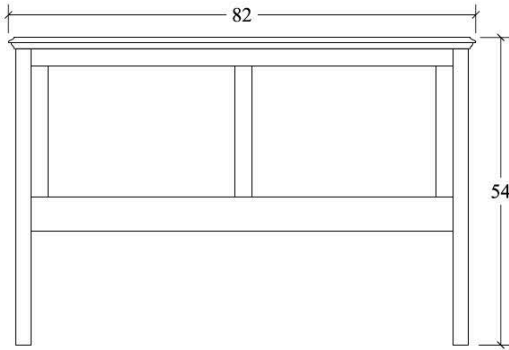

King Headboard (EAKB)
82w x 54h

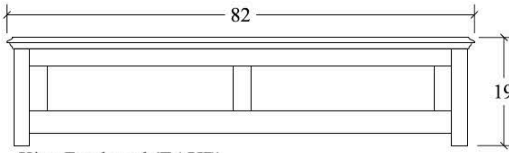

King Footboard (EAKB)
82w x 19h

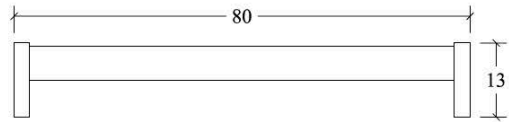

King Low Footboard (EAKB)
76w x 13h

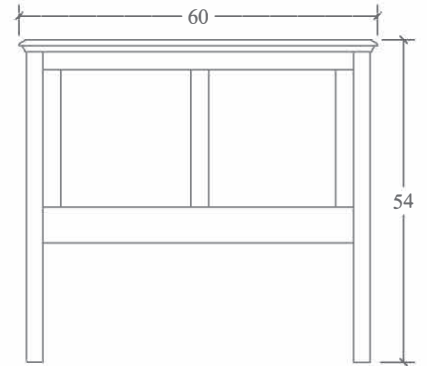

Full Headboard (EAFB)
60w x 54h

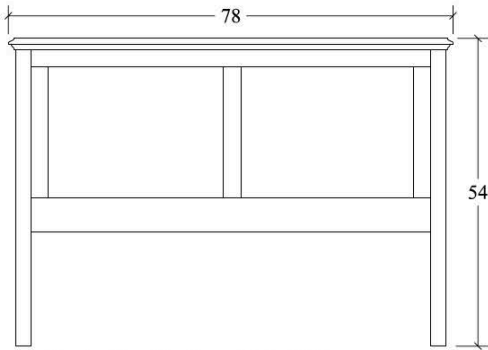

California King Headboard (CEAKB)
78w x 54h

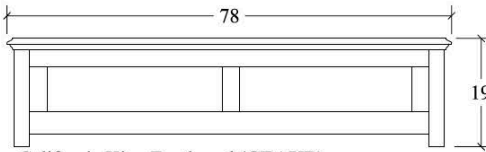

California King Footboard (CEAKB)
78w x 19h

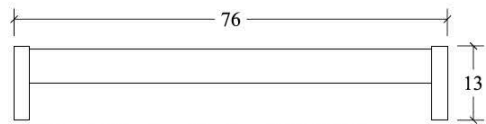

California King Low Footboard (CEAKB)
76w x 13h

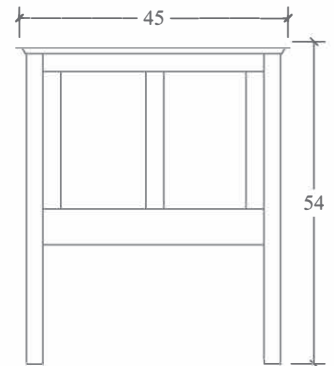

Twin Headboard (EATB)
45w x 54h

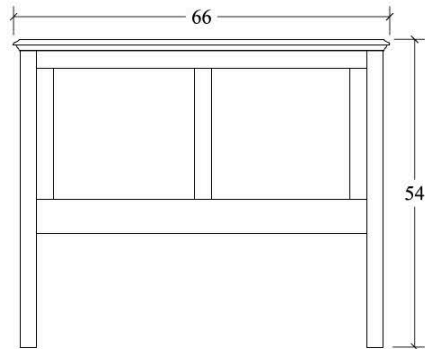

Queen Headboard (EAQB)
66w x 54h

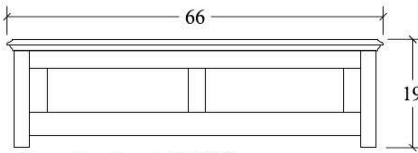

Queen Footboard (EAQB)
66w x 19h

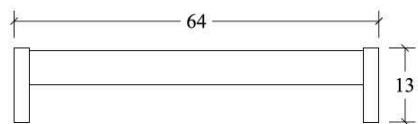

Queen Low Footboard (EAQB)
64w x 13h

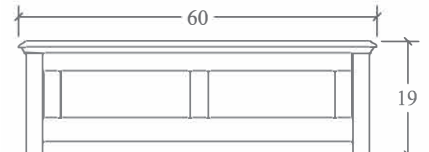

Full Footboard (EAFB)
60w x 19h

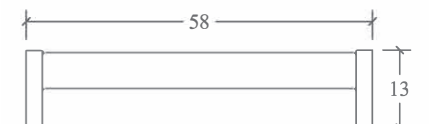

Full Footboard (EAFB)
58w x 13h

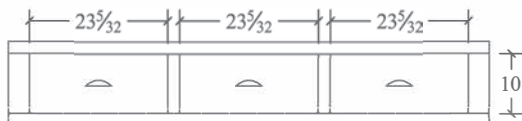

Storage Rail (EARS3)
3 drawer
80 1/2w x 14h



Twin Footboard (EATB)
45w x 19h

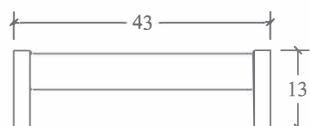

Twin Low Footboard (EATB)
43w x 13h



Mirror (EAMR)
37 3/8w x 33 3/8h

GRANDVIEW *Bedroom Collection*

COLLECTION FEATURES

- Mirrors have bevel cut edges
- Constructed with mortise and tenon joints
- Dovetailed, solid wood drawers
- Soft-closing, full extension, undermount drawer guides
- Hardware not available on other collections

COLLECTION OPTIONS

- Low footboard option
- Distressed finish (#2D)
- Underbed storage options
- Hardware options



**Grandview 3-Drawer
Nightstand**
#GVNS3
30" w x 17" d x 32 1/4" h



Oak with #51 Autumn finish

Grandview Mirror
#GVMR
42" w x 29 1/4" h

**Grandview
9-Drawer Dresser**
#GV9DR
66" w x 20" d x 42" h



**Grandview
6-Drawer Chest**
#GVCD
42" w x 20" d x 52 1/4" h



Grandview Bed
Headboard: 68 1/2" h
Footboard: 22 5/8" h
#GVKB- 84 3/4" w
#GVQB- 67 1/2" w

* see underbed storage options
on line drawings page.

GRANDVIEW

BEDROOM COLLECTION SPECIFICATIONS

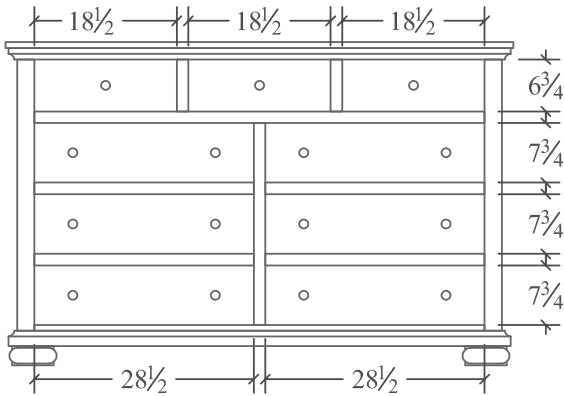

Dresser (GV9DR)
9 drawer
66w x 20d x 42h

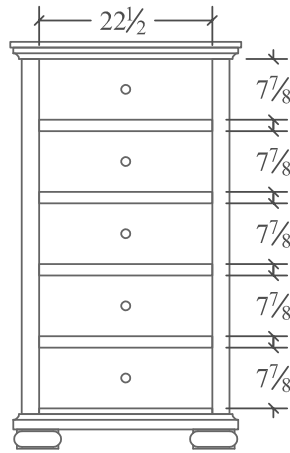

Lingerie Chest (GVLC)
5 drawer
26w x 17d x 53h

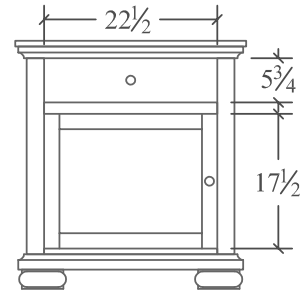

Night Stand (GVNS11L)
1 drawer, 1 door
30w x 17d x 32 1/4h

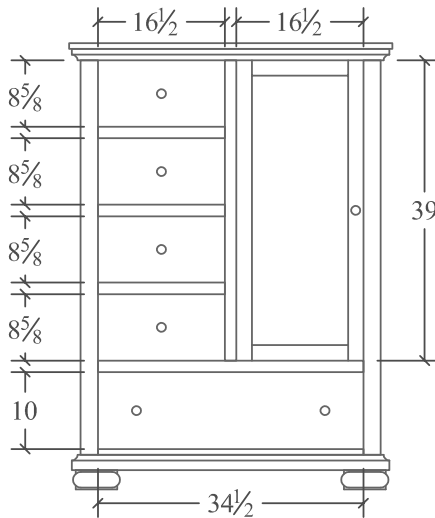

Door Chest (GVDR)
5 drawer, 1 door
42w x 20d x 58h

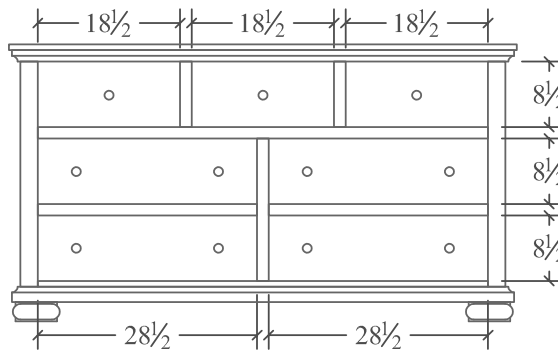

Dresser (GVDR)
7 drawer
66w x 20d x 36h

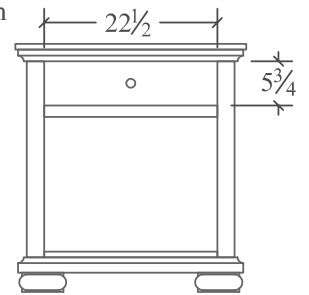

Night Stand (GVNS3)
1 drawer
30w x 17d x 32 1/4h

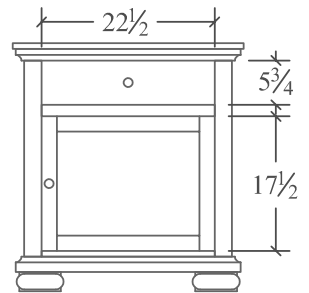

Night Stand (GVNS11R)
1 drawer, 1 door
30w x 17d x 32 1/4h

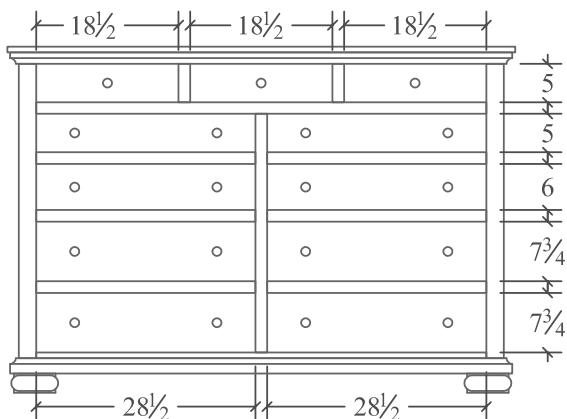

Mule Dresser (GVMDR)
11 drawer
66w x 20d x 45h



Chest (GVCD)
6 drawer
42w x 20d x 52 1/4h

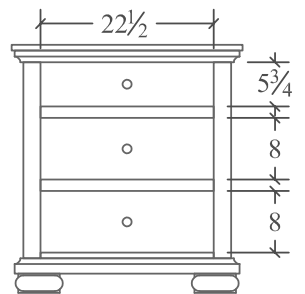

Night Stand (GVNS3)
3 drawer
30w x 17d x 32 1/4h

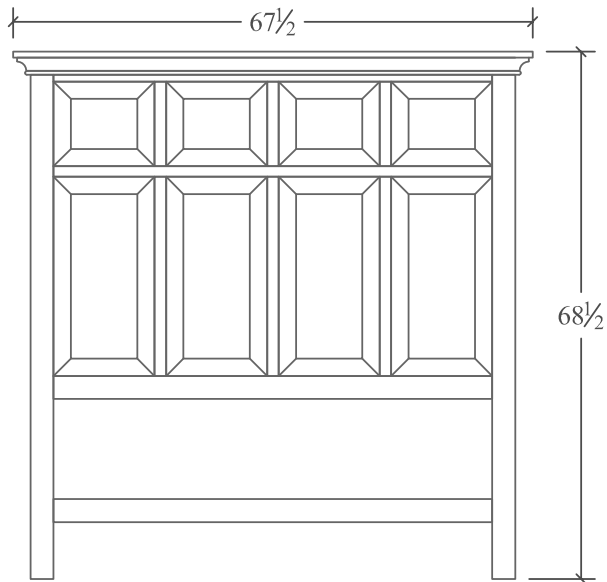

Queen Headboard (GVQB)
67 1/2w x 68 1/2h

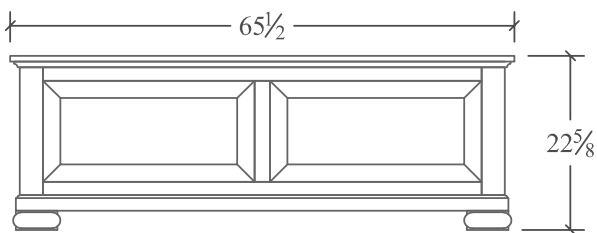

Queen Footboard (GVQB)
65 1/2w x 22 5/8h

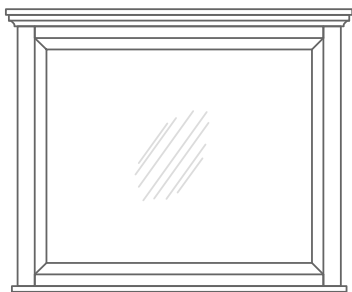

Tall Mirror (GVTMR)
42w x 35 1/4h

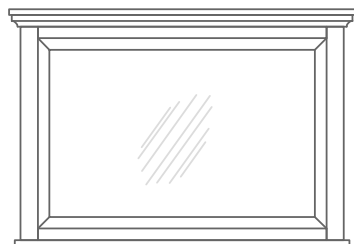

Mirror (GVMR)
42w x 29 1/4h

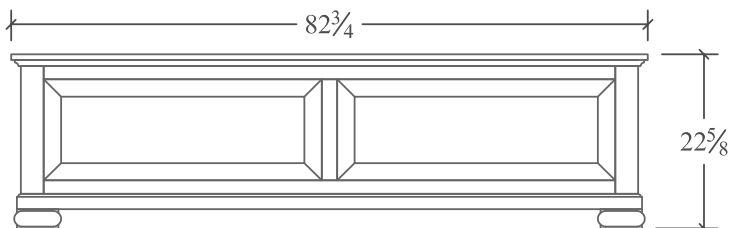

King Footboard (GVKB)
82 3/4w x 22 5/8h

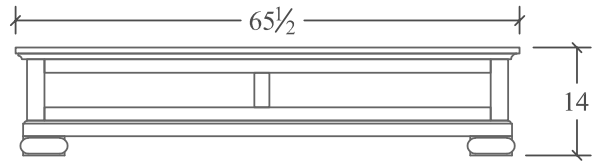

Queen Low Footboard (GVQB)
65 1/2w x 14h

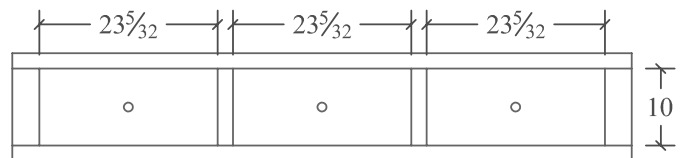

Storage Rail (GVR3)
3 drawer
80 1/2w x 14h

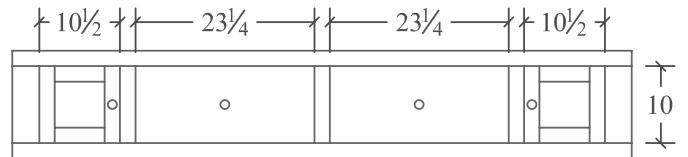

Storage Rail (GVR)
2 drawer, 2 door
80 1/2w x 14h

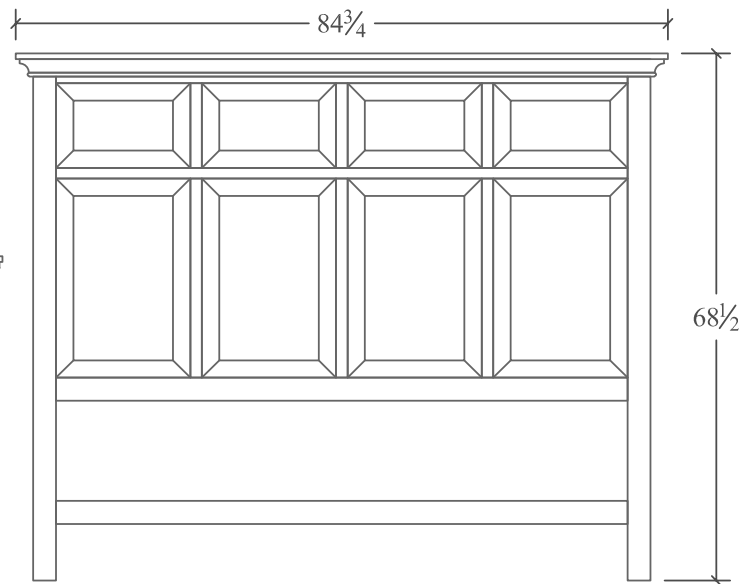

King Headboard (GVKB)
84 3/4w x 68 1/2h

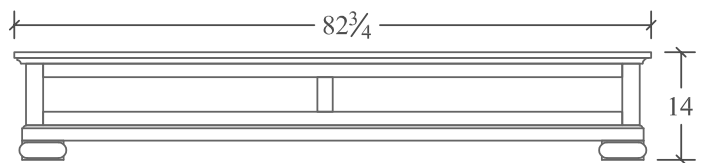

King Low Footboard (GVKB)
82 3/4w x 14h

HAYWORTH *Bedroom Collection*

COLLECTION FEATURES

- Mirror has a bevel-cut edge
- Constructed with mortise and tenon joints
- Cast dovetailed brackets support mattress
- Dovetailed, solid wood drawers
- Soft-closing, full extension, undermount drawer guides
- Case goods are fully framed, solid wood
- Bevel edge is standard

- Case goods are built with floating panel construction
- Case goods feature 1" solid top
- Armoire features 2 solid hardwood, adjustable shelves
- Chest features a cedar-lined bottom drawer
- Dresser features dividers in second row drawers
- N-14 Black Hardware

COLLECTION OPTIONS

- Distressed finish (#2D)
- Hardware options - See hardware page in Features & Options section
- Foot rail instead of footboard (#1FD)
- 6 Drawer under bed storage unit (#2RS)
- Armoire available with 1 hanger rod instead of 2 adjustable shelves

- Additional drawer dividers available in Chest or Dresser (#DD)
- Additional cedar-lined drawers available (#CB)
- Docking drawer (#DKD)



Hayworth Night Stand
#HYNS
27" w x 18" d x 30" h



Shown in Cherry with #68 Hazelnut & N-14 Black Hardware

Hayworth 6 Drawer Chest on Chest
 #HYCDC
 40" w x 22" d x 61" h



Hayworth Mirror
 #HYMR
 50" w x 32" h



Hayworth 10 Drawer Dresser
 #HYDR
 66" w x 22" d x 45" h



Hayworth Armoire
 #HYAR
 41" w x 22" d x 75" h
 *2 shelves

Hayworth Bed
 Headboard: 56" h
 Footboard: 31" h
 #CHYKB Cal. King: 78" w x 91" d
 #HYKB King: 83" w x 87" d
 #HYQB Queen: 67" w x 87" d
 #HYFB Full: 61" w x 81" d



* see underbed storage options on line drawings page.

HAYWORTH

BEDROOM COLLECTION SPECIFICATIONS

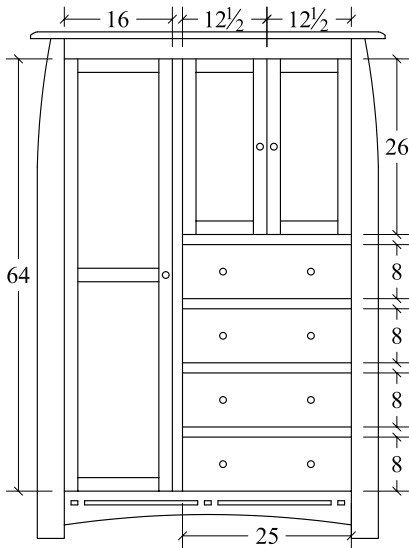

Chifferobe (HYCB)
4 drawer, 3 door
52½w x 22d x 75h
*1 shelf behind small doors
*3 shelves and 1 rod behind long door

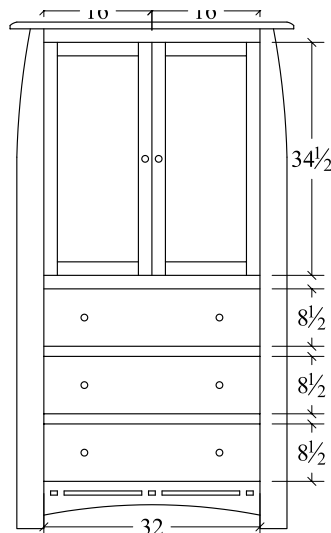

Armoire (HYAR)
3 drawer, 2 door
42w x 22d x 75h
*2 shelves

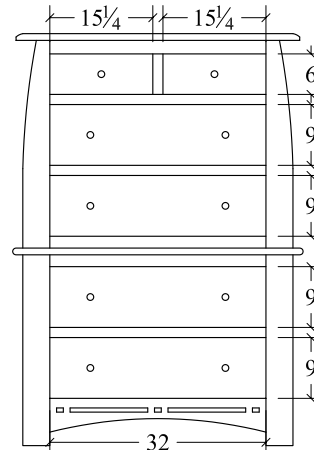

Chest on Chest (HYCDC)
6 drawer
42w x 22d x 61h

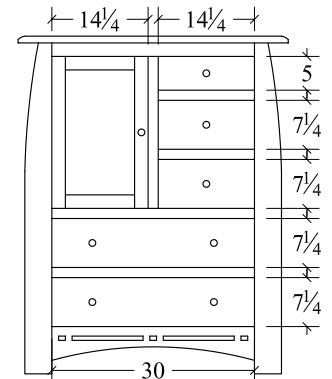

Door Chest (HYDRC)
5 drawer, 1 door
40w x 22d x 50h
*1 shelf

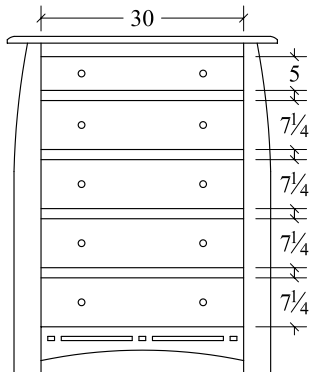

Chest (HYCD)
5 drawer
40w x 22d x 50h

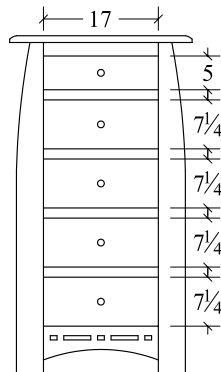

Lingerie Chest (HYLC)
5 drawer
27w x 18d x 50h

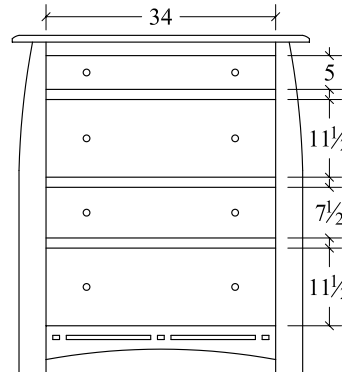

Desk Chest (HYDC)
4 drawer
44w x 22d x 50h

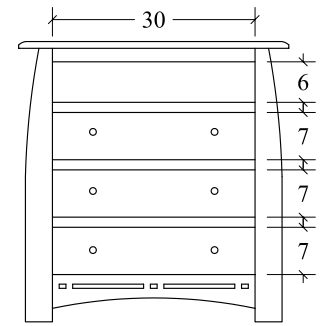

Media Chest (HYMC)
3 drawer, 1 opening
40w x 22d x 41½h

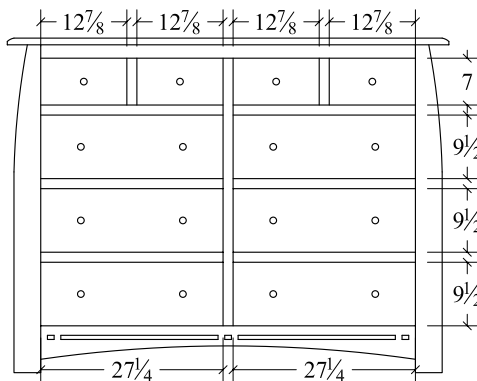

Dresser (HYDR)
10 drawer
66w x 22d x 50h

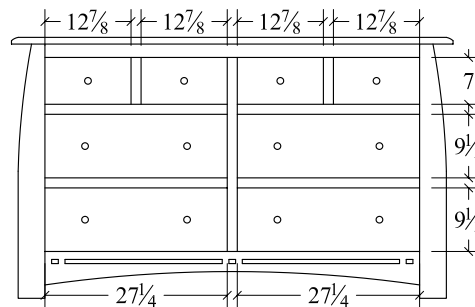

Dresser (HY8DR66)
8 drawer
66w x 22d x 39h

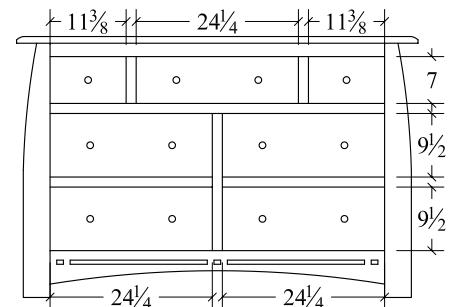

Dresser (HY7DR60)
7 drawer
60w x 22d x 39h

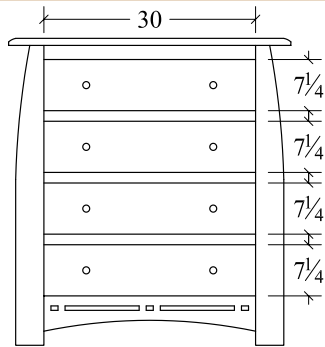

Chest (HYCD4)
4 drawer
40w x 22d x 44h

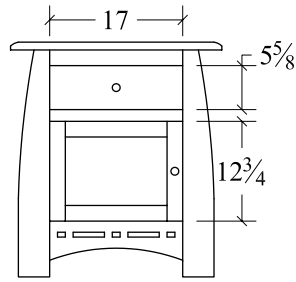

Nightstand (HYNSII)
1 drawer, 1 door
27w x 18d x 30h

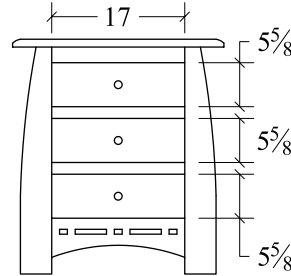

Nightstand (HYNS)
3 drawer
27w x 18d x 30h

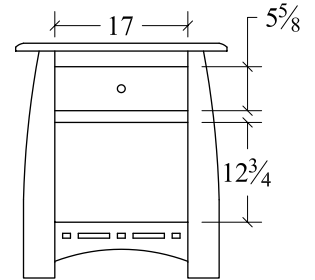

Nightstand (HYNSI)
1 drawer, 1 opening
27w x 18d x 30h

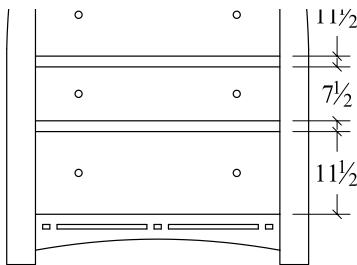

Desk Chest (HYDC)
4 drawer
44w x 22d x 50h

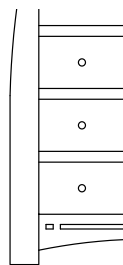

Chest (HYC)
4 drawer
40w x 22d

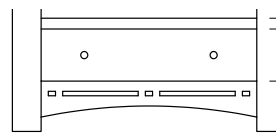

Chest (HYCD)
5 drawer
40w x 22d x 50h

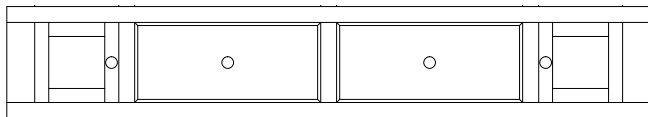
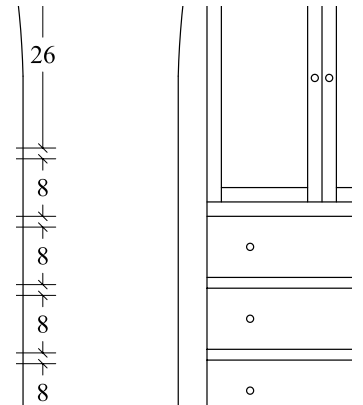
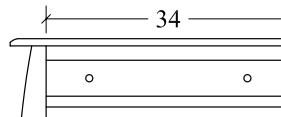

Bed Storage Rail
2 door, 2 drawer

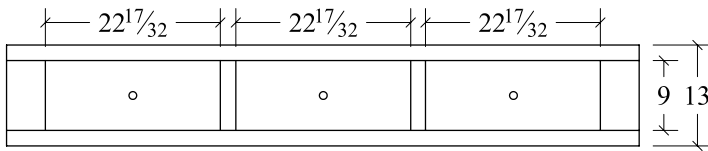

Bed Storage Rail
3 drawer
See pricelist for underbed storage order info

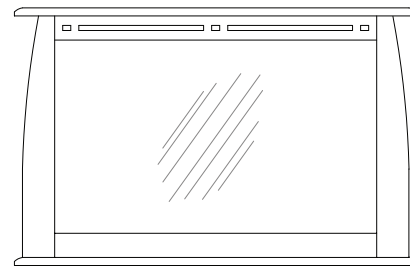

Mirror (HYMR)
50w x 32h

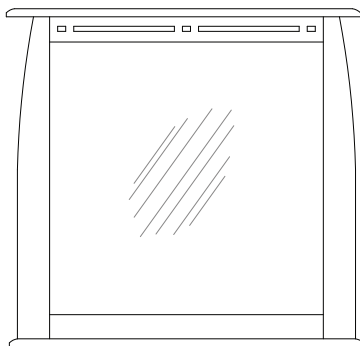

Mirror (HYMR44)
44w x 42h

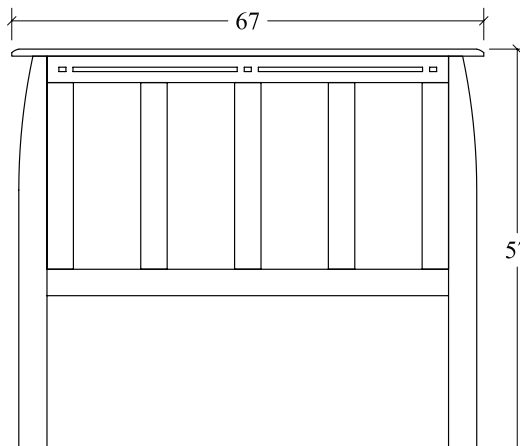

Queen Headboard (HYQB)
67w x 57h

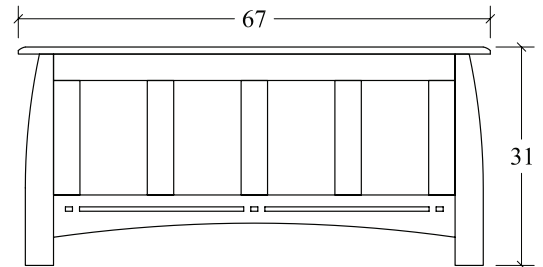

Queen Footboard (HYQB)
67w x 31h

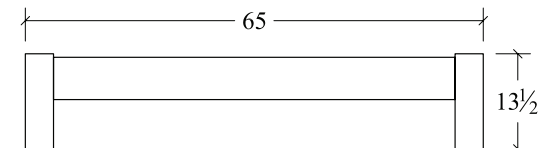

Queen Low Footboard (HYQB)
65w x 13 1/2h

OLD MISSION *Bedroom Collection*

COLLECTION FEATURES

- Dovetailed, solid wood drawers
- Full extension, side mounted, ball bearing guides
- Fully framed, solid hardwood case goods
- W-2 Hardware
- Mission edge is standard

COLLECTION OPTIONS

- Hardware Options (see Features & Options page)
- Foot rail is available instead of footboard
- Underbed storage available



Old Mission
3 Drawer Night Stand
#OMNS3
23" w x 17" d x 29 1/2" h



Featuring **full extension side mounted slides**



Shown in Oak with #32 Michaels Finish & W-2 Hardware

**Old Mission
6 Drawer Chest**
#OMCD

37" w x 21 1/2" d x 52 1/2" h

Old Mission Mirror

#OMMR
52" w x 42" h



Old Mission 7 Drawer Dresser

#OMDR
60" w x 21 1/2" d x 38" h



Old Mission Underbed Storage Option

#OMRS

Old Mission Slat Bed
Headboard posts: 56" h
Footboard posts: 28" h
#COMKB Cal. King: 85" w x 92" d
#OMKB King: 89" w x 88" d
#OMQB Queen: 73" w x 88" d
#OMFB Full: 67" w x 84" d
#OMTB Twin: 54" w x 84" d

Shown with
Storage Rail option



* see underbed storage options
on line drawings page.

OLD MISSION

BEDROOM COLLECTION SPECIFICATIONS

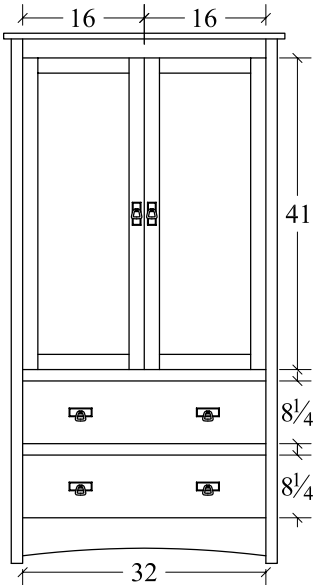

Armoire (OMAR)
2 drawer, 2 door
37w x 21 1/2d x 70h
*2 shelves

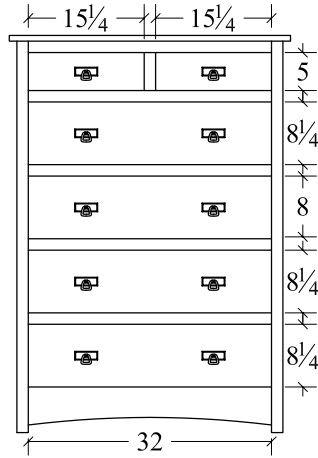

Chest (OMCD)
6 drawer
37w x 21 1/2d x 52 1/2h

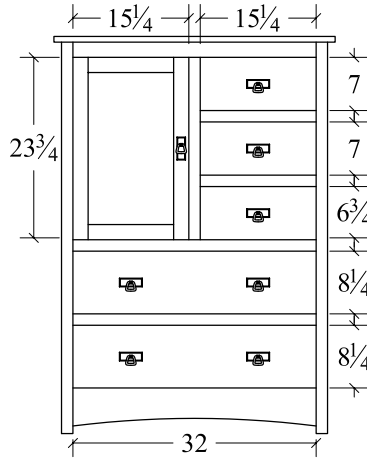

Door Chest (OMDRC)
5 drawer, 1 door
37w x 21 1/2d x 52 1/2h
*1 shelf behind door

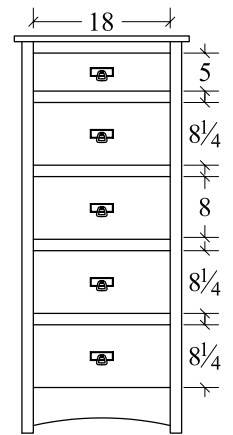

Lingerie Chest (OMLC)
5 drawer
23w x 17d x 52 1/2h

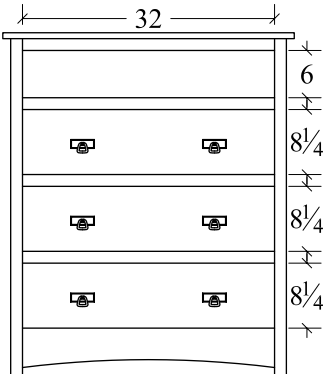

Media Chest (OMMC)
3 drawer, 1 opening
37w x 21 1/2d x 43 1/2h

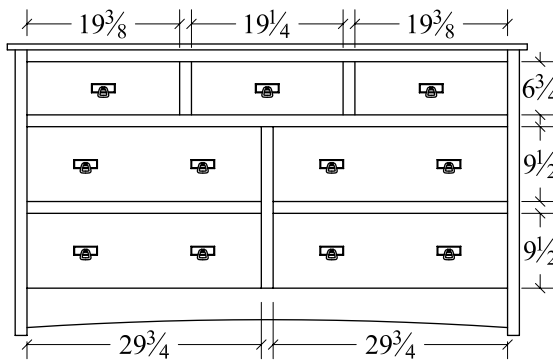

Dresser (OMDR66)
7 drawer
66w x 21 1/2d x 38h

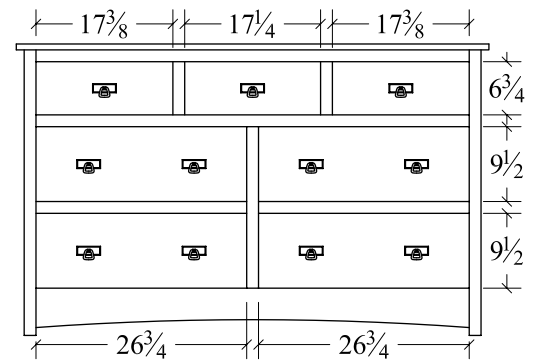

Dresser (OMDR)
7 drawer
60w x 21 1/2d x 38h

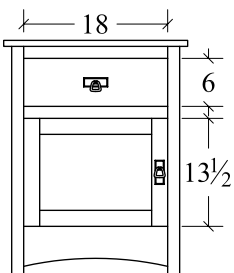

Night Stand (OMNS11L)
1 drawer, 1 door
23w x 17d x 29 1/2h

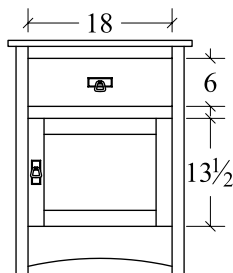

Night Stand (OMNS11R)
1 drawer, 1 door
23w x 17d x 29 1/2h

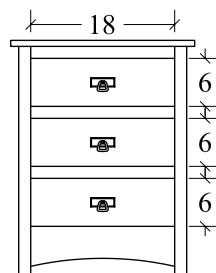

Night Stand (OMNS3)
3 drawer
23w x 17d x 29 1/2h

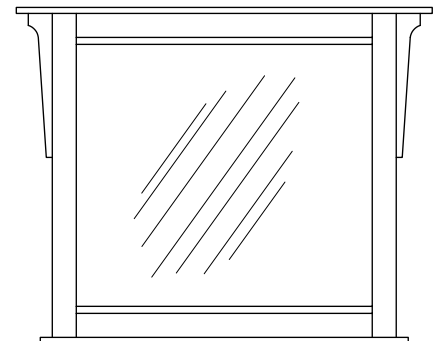

Mirror (OMMR)
52w x 42h

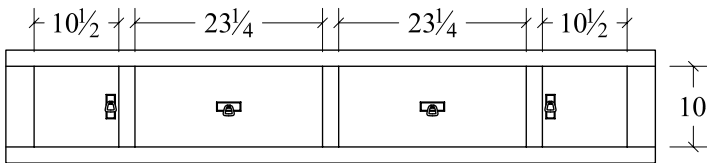

Storage Rail
2 drawer, 2 door
14h

See pricelist for underbed
storage order info

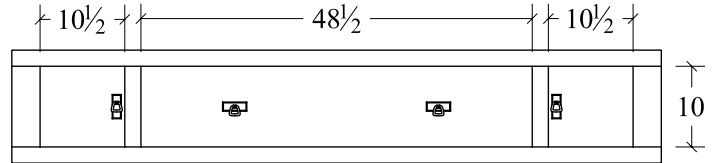

Storage Rail
1 drawer, 2 door
14h

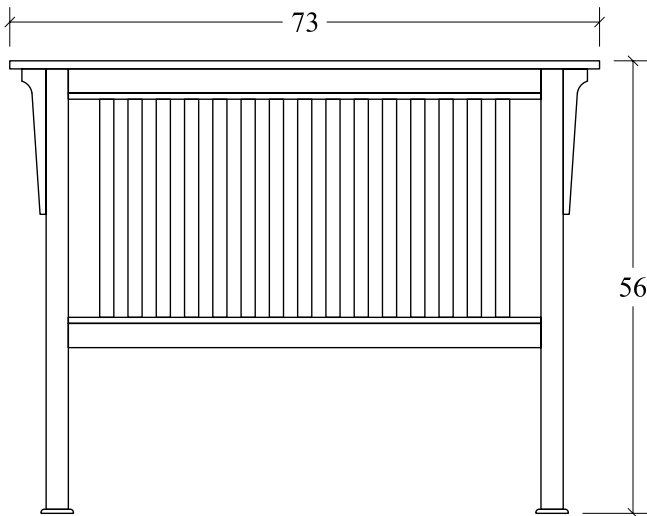

Queen Headboard (OMQB)
73w x 56h

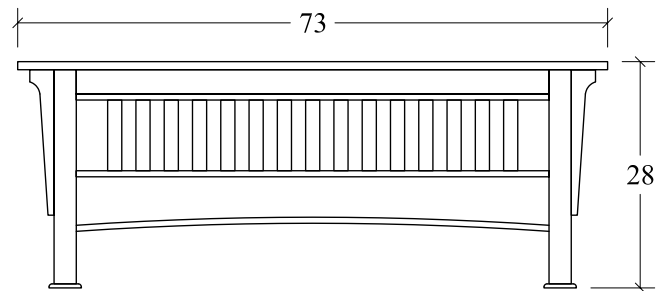

Queen Footboard (OMQB)
73w x 28h

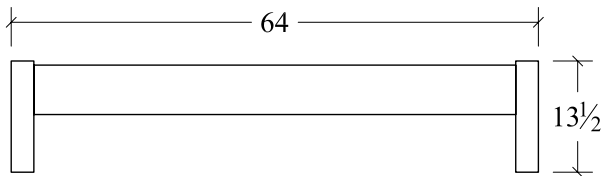

Queen Low Footboard (OMQB)
64w x 13 1/2h

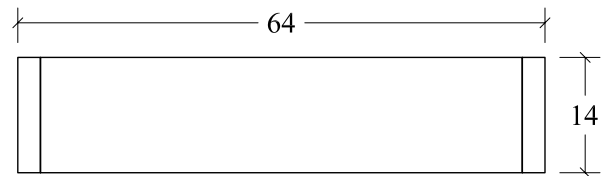

Queen Low Footboard
For Storage Rails (OMBQB)
64w x 14h

OLD MISSION BOOKCASE

Bedroom Collection

COLLECTION FEATURES

- Dovetailed, solid wood drawers
- Full extension, side mounted, ball bearing guides
- Fully framed, solid hardwood case goods
- W-2 Hardware
- Mission edge is standard

COLLECTION OPTIONS

- Hardware Options (see Features & Options page)
- Underbed storage available



Featuring **full extension side mounted slides**



Old Mission
3 Drawer Night Stand
#OMNS3
23" w x 17" d x 29 1/2" h



Shown in Oak with #32 Michaels Finish & W-2 Hardware



**Old Mission
6 Drawer Chest**
#OMCD
37"w x 21 1/2"d x 52 1/2"h



Old Mission Mirror
#OMMR
52"w x 42"h

Old Mission 7 Drawer Dresser
#OMDR
60"w x 21 1/2"d x 38"h



**Old Mission Underbed
Storage Option**
#OMRS



Mission Hall Tree
#M100131
2" x 2" Post, 70" Tall
Oak

Old Mission Bookcase Bed
Headboard posts: 48"h
Footboard posts: 14"h
#COMBKB Cal. King: 78"w x 97 3/4"d
#OMBKB King: 82"w x 93 3/4"d
#OMBQB Queen: 66"w x 93 3/4"d
#OMBFB Full: 60"w x 89 3/4"d
#OMBTB Twin: 45"w x 89 3/4"d



* see underbed storage options
on line drawings page.

Shown with
Storage Rail option

OLD MISSION BOOKCASE

BEDROOM COLLECTION SPECIFICATIONS

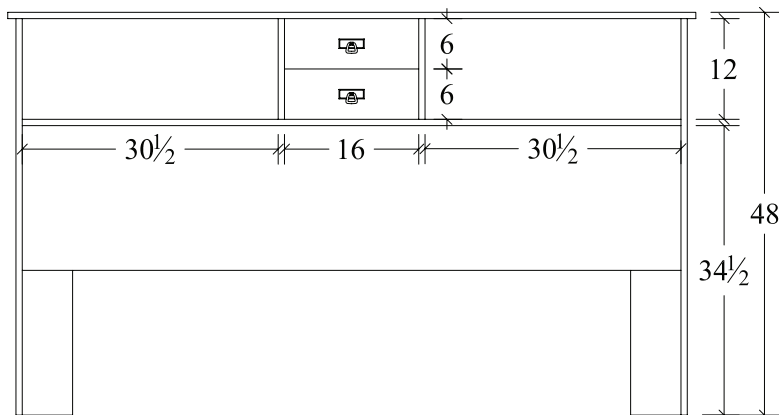

King Head Board (OMBKB)
2 drawer, 2 openings
82w x 12d x 48h

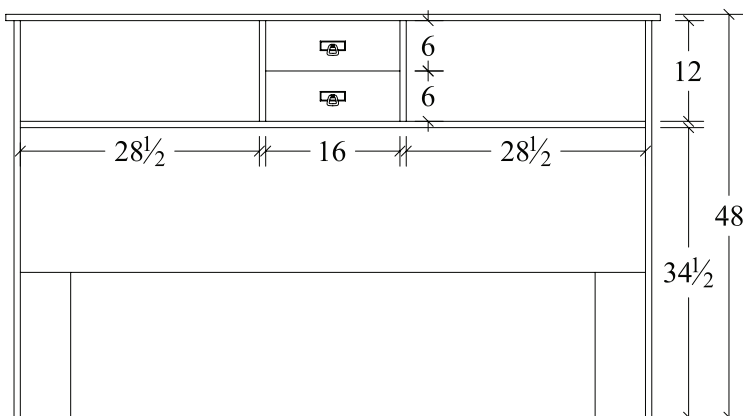

Cal. King Head Board (COMBKB)
2 drawer, 2 openings
78w x 12d x 48h

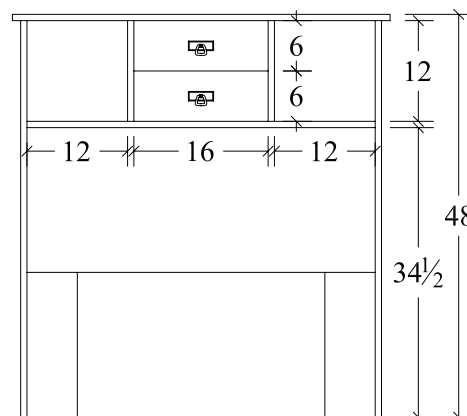

Twin Head Board (OMBTB)
2 drawer, 2 openings
45w x 12d x 48h

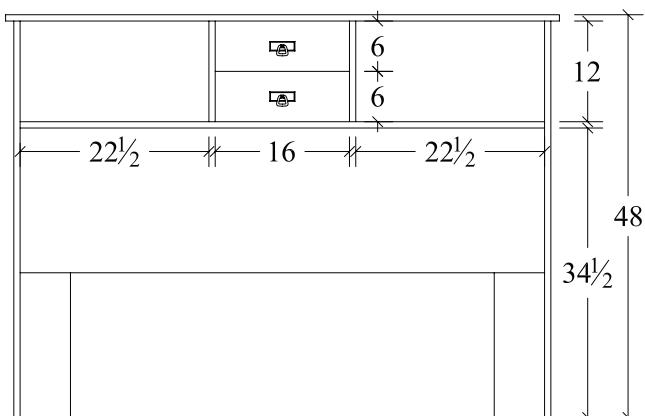

Queen Head Board (OMBQB)
2 drawer, 2 openings
66w x 12d x 48h

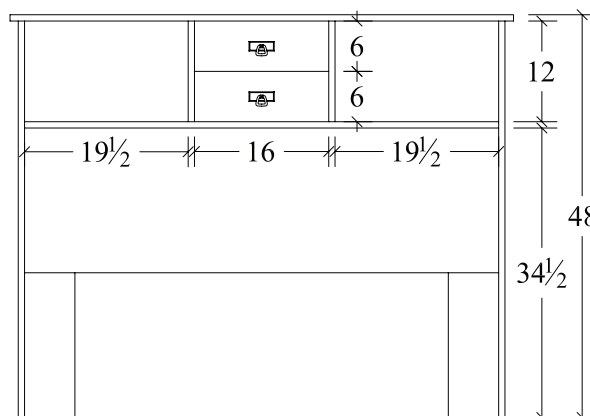

Full Head Board (OMBFB)
2 drawer, 2 openings
60w x 12d x 48h



PLATTE RIVER *Bedroom Collection*

COLLECTION FEATURES

- Constructed with mortise and tenon joints
- Cast dovetailed brackets support mattress
- Dovetailed, solid wood drawers
- Full extension, side mounted, ball-bearing guides
- SO-1 knobs for hardware

COLLECTION OPTIONS

- Hardware options (see Features & Options page)
- Underbed storage available



Platte River
3 Drawer Nightstand
#PLRNS3
23" w x 17" d x 29 1/2" h



Shown in Brown Maple with #113 Oatmeal



**Platte River
52\"/>**



**Platte River
6 Drawer Chest**
#PLRCD
37\"/>

**Platte River 7 Drawer
60\"/>**



Platte River Bed
Headboard posts: 51" h
Footboard posts: 19" h
#CPLRKB Cal. King: 79" w x 92" d
#PLRKB King: 83" w x 88" d
#PLRQB Queen: 67" w x 88" d
#PLRFB Full: 61" w x 84" d
#PLRTB Twin: 48" w x 84" d

* see underbed storage options
on line drawings page.

PLATTE RIVER

BEDROOM COLLECTION SPECIFICATIONS

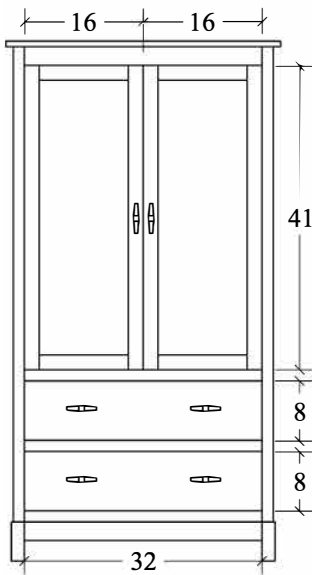

Armoire (PLRAR)
2 drawer, 2 door
37w x 21 1/2d x 70h
*2 shelves

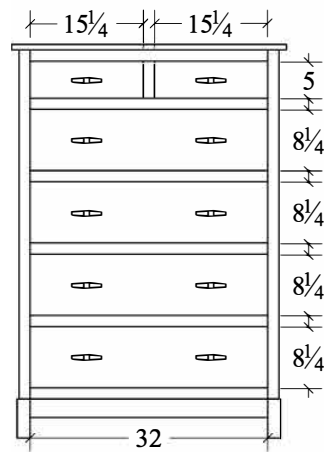

Chest (PLRCD)
6 drawer
37w x 21 1/2d x 53h

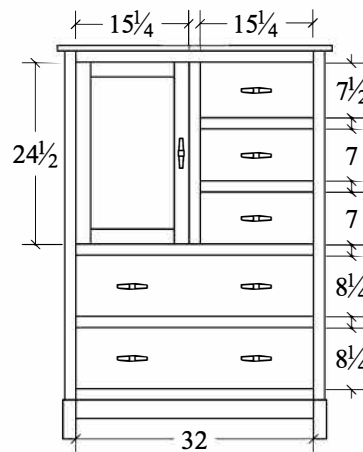

Door Chest (PLRDRC)
5 drawer, 1 door 37w x
21 1/2d x 53h

*1 shelf behind door

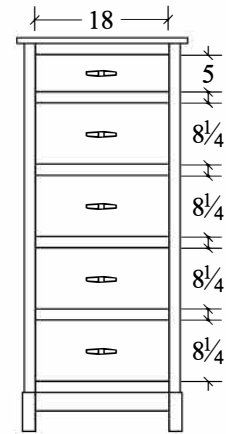

Lingerie Chest (PLRLC)
5 drawer
23w x 17d x 53h

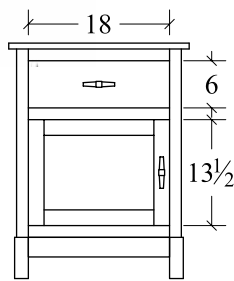

Night Stand (PLRNS11L)
1 drawer, 1 door
23w x 17d x 29 1/2h

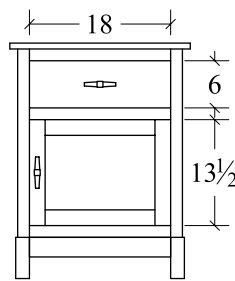

Night Stand (PLRNS11R)
1 drawer, 1 door
23w x 17d x 29 1/2h

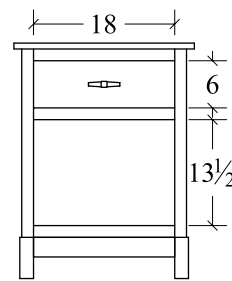

Night Stand (PLRNS1)
1 drawer
23w x 17d x 29 1/2h

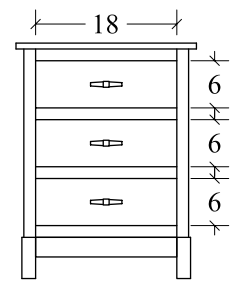

Night Stand (PLRNS3)
3 drawer
23w x 17d x 29 1/2h

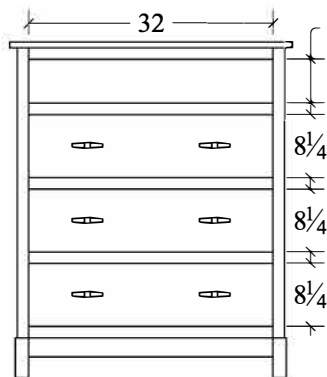

Media Chest (PLRMC)
3 drawer, 1 opening
37w x 21 1/2d x 44h

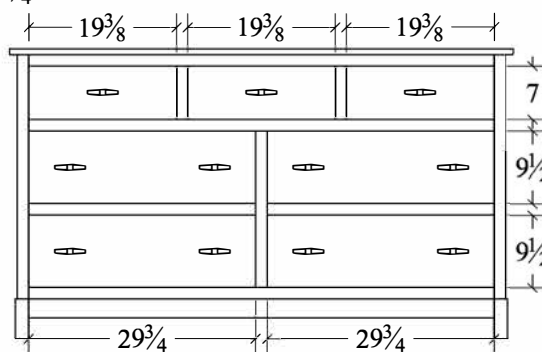

Dresser (PLRDR66)
7 drawer
66w x 21 1/2d x 38h

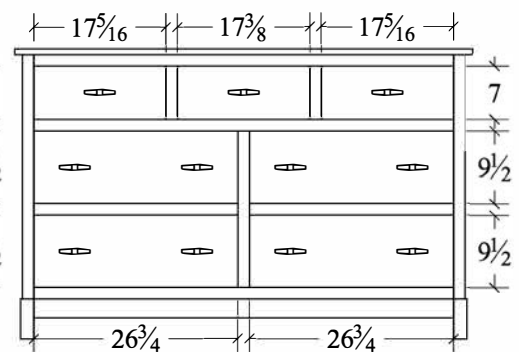

Dresser (PLRDR)
7 drawer
60w x 21 1/2d x 38h

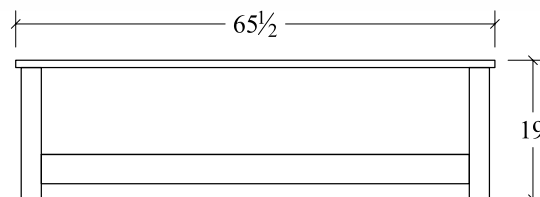

Queen Footboard (2-PLRQB)
65 1/2w x 19h

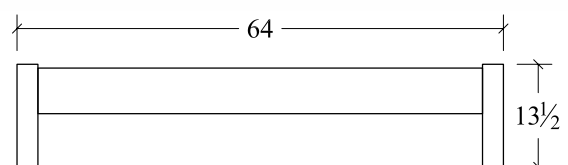

Queen Low Footboard (3-PLRQBLFB)
64w x 13 1/2h

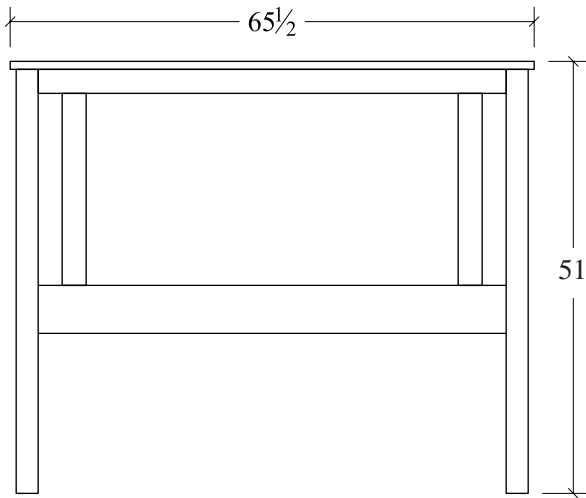

Queen Headboard (1-PLRQB)

65 1/2w x 54h

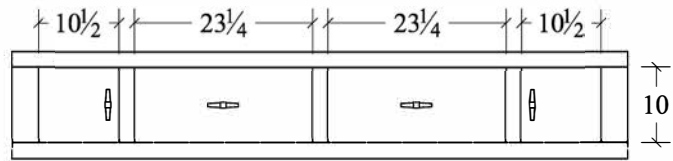

Storage Rail (3-PLRQBRs)

2 drawer, 2 door

80 1/2w x 14h

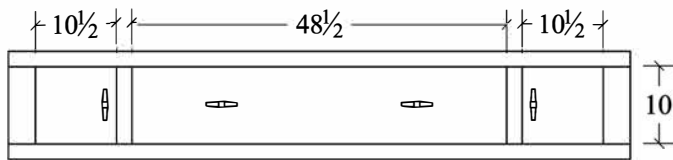

Storage Rail (3-2PLRQBRS)

1 drawer, 2 door

80 1/2w x 14h

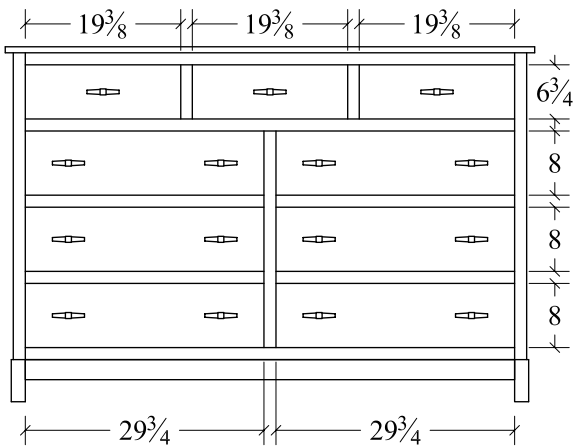

Dresser (PLRDR9)

9 drawer

66w x 21 1/2d x 44 1/4h

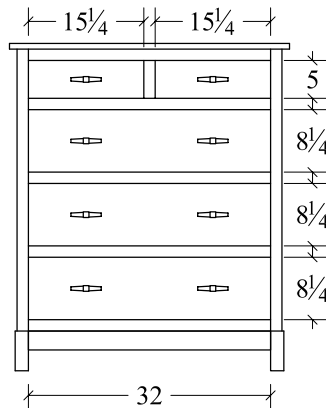

Chest (PLRC05)

5 drawer

37w x 21 1/2d x 43 1/4h

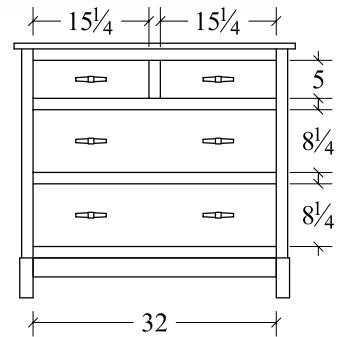

Chest (PLRC04)

4 drawer

37w x 21 1/2d x 33 1/2h

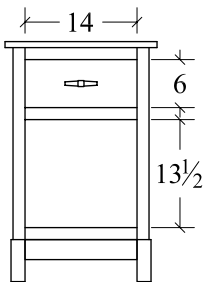

Night Stand (PLRNS119)

1 drawer

19w x 17d x 29 1/2h

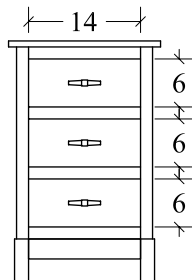

Night Stand (PLRNS319)

3 drawer

19w x 17d x 29 1/2h

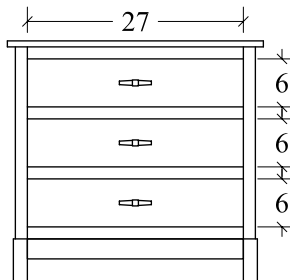

Night Stand (PLRNS332)

3 drawer

32w x 17d x 29 1/2h

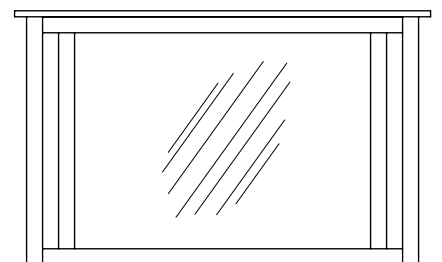

Mirror (PLRMR32)

52w x 32h

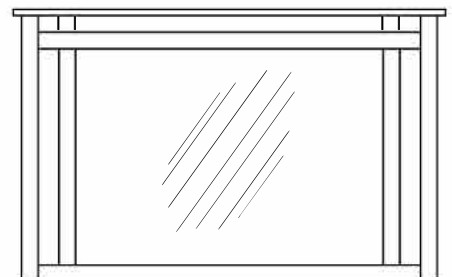

Mirror (PLRMR)

52w x 40h

SAVANNAH *Bedroom Collection*

COLLECTION FEATURES

- Mirror has a bevel-cut edge
- Constructed with mortise and tenon joints
- Cast dovetailed brackets support mattress
- Dovetailed, solid wood drawers
- Soft-closing, full extension, undermount drawer guides
- Case goods are fully framed, solid wood
- Case goods are built with floating panel construction
- Case goods feature 1" solid top

- Armoire features 2 solid hardwood adjustable shelves
- Chest features a cedar-lined bottom drawer
- Dresser features dividers in second row drawers
- Desk chest features pullout tray with drawers and bottom drawer file cabinet
- H-8 Hardware
- Mission edge is standard

COLLECTION OPTIONS

- Distressed finish (#2D)
- Hardware Options (see Features & Options page)
- Foot rail instead of footboard (#1FD)
- Under bed storage unit (#2RS)
- Three plug power strip. Case goods available with touch switch LED night light (#LEDN)
- Night Stand available with sliding top, hidden compartment, lock and three plug power strip (#STP)
- Armoire available with 1 hanger rod instead of 2 adjustable shelves
- Additional adjustable armoire shelves available (#AJS)
- Additional drawer dividers available (#DD)
- Dresser drawer available with felt-lined jewelry tray (#SJT)
- Additional cedar-lined drawers available (#CB)
- Docking drawer (#DKD)



Savannah 2 Drawer Nightstand
#SHNS
24" w x 16 1/2" d x 30" h



Shown in Quartersawn Oak with #30 Asbury Stain & H-8 Hardware



Savannah Armoire
#SHAR
42"w x 23"d x 71"h
*2 shelves behind doors



Savannah Mirror
#SHMR
52"w x 31"h

**Savannah
9 Drawer Dresser**
#SHDR
66"w x 22"d x 45"h

Savannah Lingerie Chest
#SHLC
24"w x 16 1/2"d x 53"h



Savannah Bed
Headboard: 58"h
Footboard: 24"h
#CSHKB Cal. King: 81"w x 92"d
#SHKB King: 85"w x 88"d
#SHQB Queen: 69"w x 88"d
#SHFB Full: 63"w x 82"d



* see underbed storage options
on line drawings page.

SAVANNAH *Bedroom Collection*

CONTINUED...



Savannah Blanket Chest
#SHBC
48"w x 20"d x 24"h



Savannah 6 Drawer Chest
#SHCD
40"w x 22"d x 53"h



ALTERNATIVE BED OPTIONS:

Beckley Bed

Headboard: 58"h

Footboard: 36"h

#CBYKB Cal. King: 77 1/2"w x 90"d

#BYKB King: 81 1/2"w x 86"d

#BYQB Queen: 65 1/2"w x 86"d

#BYFB Full: 59 1/2"w x 80"d

* see underbed storage options
on line drawings page.

SAVANNAH

BEDROOM COLLECTION SPECIFICATIONS

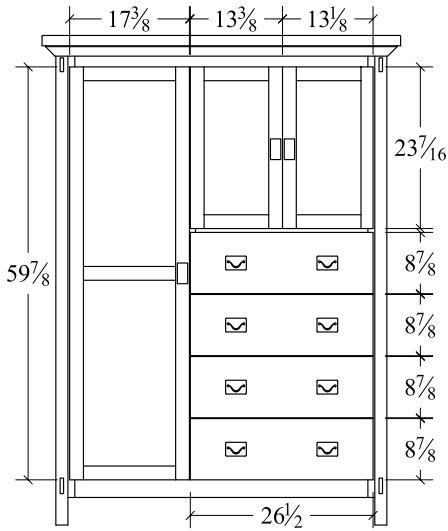

Chifferobe (SHCB)
4 drawer, 3 door
52w x 23d x 71h
*1 shelf behind small doors
*3 shelves and 1 rod behind long door

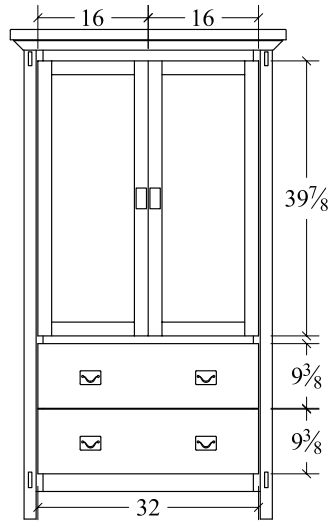

Armoire (SHAR)
2 drawer, 2 door
42w x 23d x 71h
*2 shelves

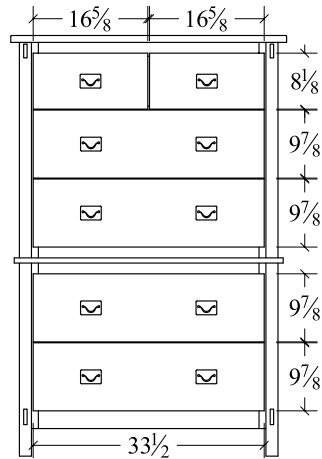

Chest on Chest (SHCDC)
6 drawer
40w x 22d x 61h

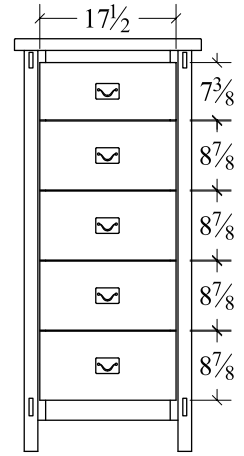

Lingerie Chest (SHLC)
5 drawer
24w x 16 1/2d x 53h

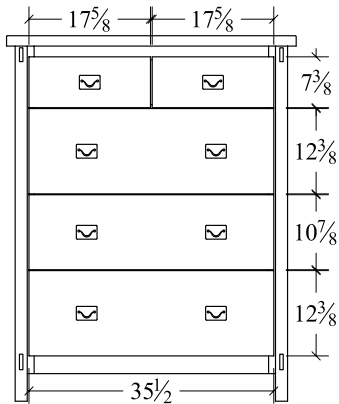

Desk Chest (SHDC)
5 drawer
42w x 22d x 53h

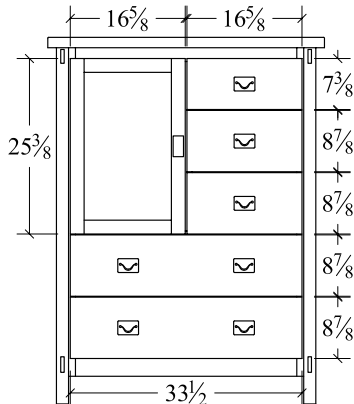

Door Chest (SHDRC)
5 drawer, 1 door
42w x 22d x 53h
*1 shelf behind door

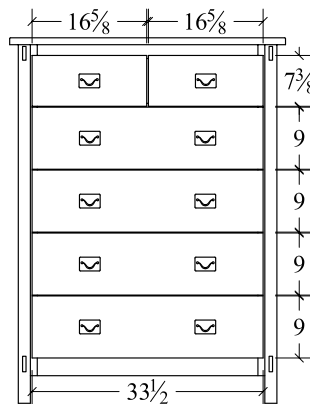

Chest (SHCD)
6 drawer
40w x 22d x 53h

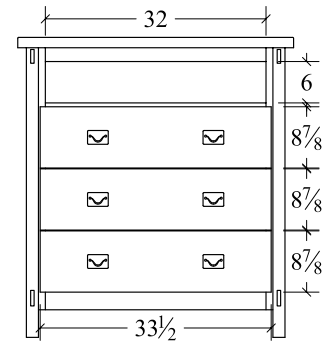

Media Chest (SHMC)
3 drawer, 1 opening
40w x 22d x 43h

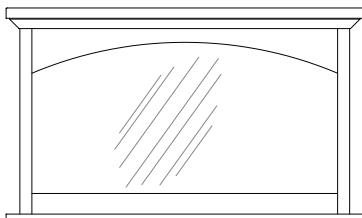

Mirror (SHMR)
52w x 31h

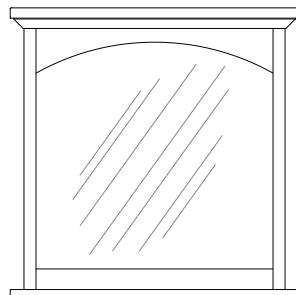

Mirror (SHMR40)
42w x 42h

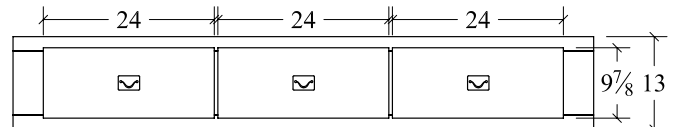

Bed Storage Rail
3 drawer

See pricelist for underbed storage order info.

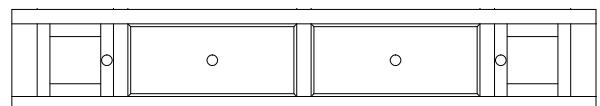

Bed Storage Rail
2 door, 2 drawer

SAVANNAH

BEDROOM COLLECTION SPECIFICATIONS

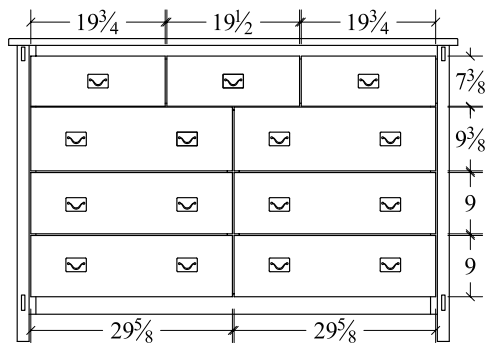

Dresser (SHDR)
9 drawer
66w x 22d x 45h

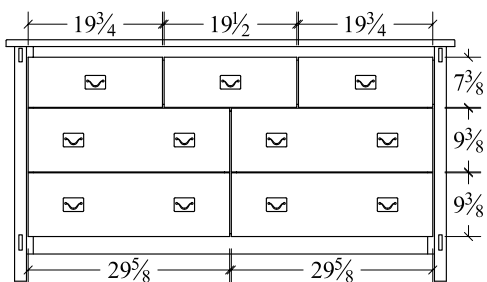

Dresser (SH7DR66)
7 drawer
66w x 22d x 36h



Dresser (SH7DR60)
7 drawer
60w x 22d x 36h

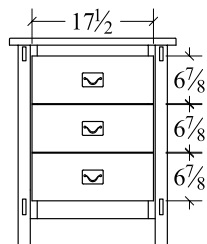

Nightstand (SHNS3)
3 drawer
24w x 16 1/2d x 30h

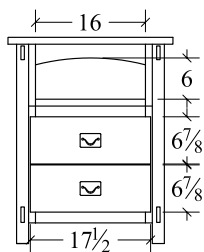

Nightstand (SHNS)
2 drawer, 1 opening
24w x 16 1/2d x 30h

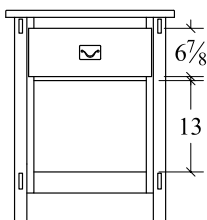

Nightstand (SHNS1)
1 drawer, 1 opening
24w x 16 1/2d x 30h

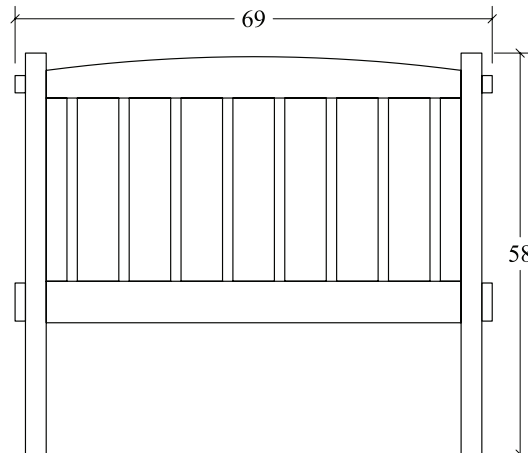

Queen Headboard (BYQB)
69w x 58h

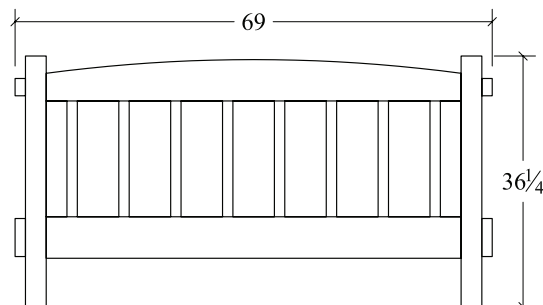

Queen Footboard (BYQB)
69w x 36 1/4h

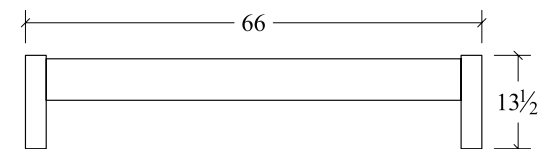

Queen Low Footboard (BYQB)
66w x 13 1/2h

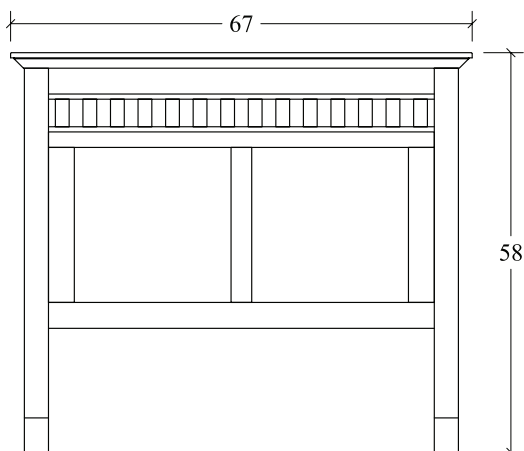

Queen Headboard (SHQB)
67w x 58h

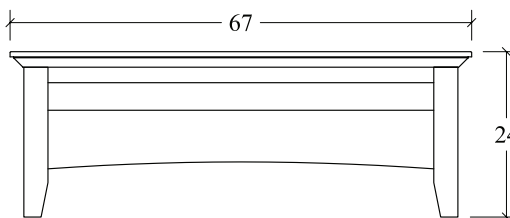

Queen Footboard (SHQB)
67w x 24h

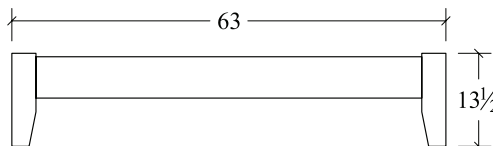

Queen Low Footboard (SHQB)
63w x 13 1/2h



SIMPLICITY *Bedroom Collection*

COLLECTION FEATURES

- Mirrors have bevel cut edges
- Constructed with mortise and tenon joints
- Dovetailed, solid wood drawers
- Soft-closing, full extension, undermount drawer guides
- Cutout in drawer fronts for handles
- Top has grooves

**Simplicity cannot have sliding top option, nightlights, or docking stations*

COLLECTION OPTIONS

- Low footboard option
- Distressed finish (#2D)
- Underbed storage options
- Choose any fabric or leather from the Fusion options



Walnut Inlays and bases on select case goods are standard

Drawing from the streamlined looks and clean lines of mid-century modern design and pared-down aesthetic of Scandinavian spaces, the Simplicity collection is a contemporary interpretation of Shaker style re-imagined for today's more modern tastes. Smaller-scaled with an emphasis on flexibility, the collection is marked by angular posts and pilasters and functional open shelving that offers the fresh and airy feeling indicative of these serene, light-filled styles. Finished in a mellow brown maple stain coupled with tapered walnut bases, legs, and contrasting walnut bow tie accents, these multi-functional bedroom pieces easily move from one room to another depending on decorating needs.



Shown in Brown Maple with walnut accents and #99 Toffee finish.

Simplicity Panel Bed

Footboard: 18" h

#51-1501T Twin: 41 1/2" x 60"

#51-1501F Full: 57 1/2" x 60"

#51-1501Q Queen: 63 1/2" x 60"

#51-1501K King: 79 1/2" x 60"

#51-1501C Cal King: 75 1/2" x 60"



Simplicity Upholstered Bed

Footboard: 18" h

#51-1502T Twin: 42 1/2" x 58"

#51-1502F Full: 57 1/2" x 58"

#51-1502Q Queen: 63 1/2" x 58"

#51-1502K King: 79 1/2" x 58"

#51-1502C Cal King: 75 1/2" x 58"

* see underbed storage options
on line drawings page.

SIMPLICITY *Bedroom Collection*

CONTINUED...



Simplicity 3 Drawer Nightstand
#51-1603
28" w x 18" d x 29" h



Simplicity Open Nightstand
#51-1602
28" w x 18" d x 28" h

Simplicity 6 Drawer Chest
#51-1801
40" w x 19" d x 54" h

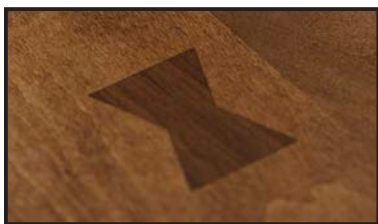

Walnut Inlays and bases on select case goods are standard



Middle drawer of
Media Dresser folds down



**Simplicity
Media Dresser**
#51-1701
56" w x 19" d x 44" h

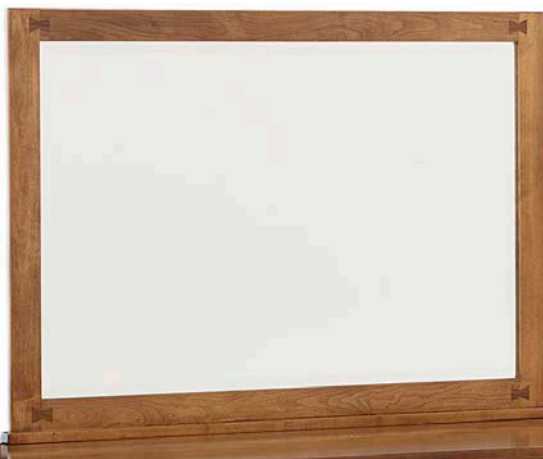

**Simplicity
Landscape Mirror**
#51-2001
43" w x 30" h

**Simplicity Tall
Landscape Mirror
(not shown)**
#51-2002
43" w x 36" h



**Simplicity 8 Drawer
Dresser**
#51-1702
64" w x 19" d x 36" h



SIMPLICITY

BEDROOM COLLECTION SPECIFICATIONS

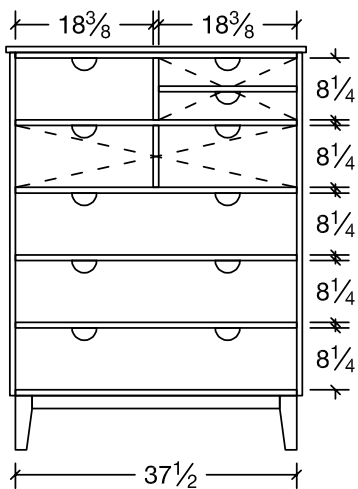

51-1801
6 Drawer Chest
6 drawer
40w x 19d x 53³/₄h

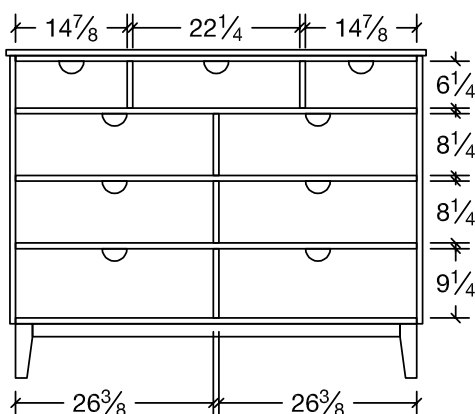

51-1701
Media Dresser
8 drawer
56w x 19d x 43³/₄h

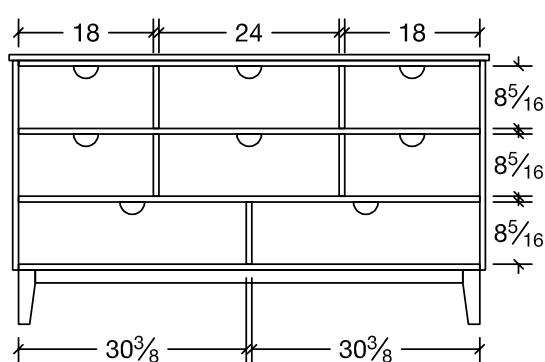

51-1702
8 Drawer Dresser
8 drawer
64w x 19d x 36h

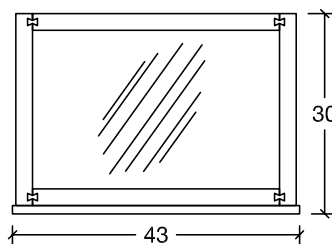

51-2001
Landscape Mirror
43w x 30h

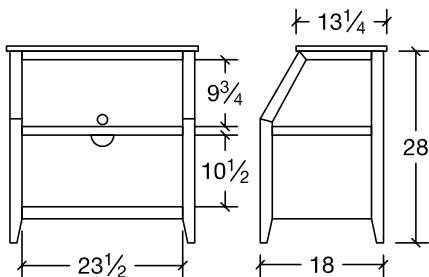

51-1602
Open Night Stand
1 Drawer, 1 Shelf
28w x 18d x 28h

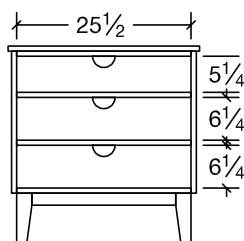

51-1603
3 Drawer Night Stand
3 Drawers
28w x 18d x 28³/₄h

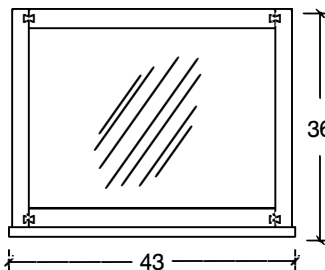

51-2002
Landscape Mirror
43w x 36h

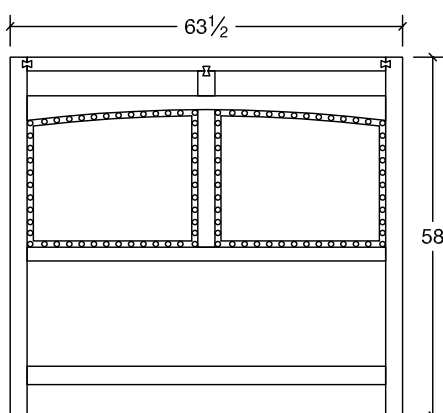

1-51-1502Q
Queen Upholstered
Headboard
63¹/₂w x 58h

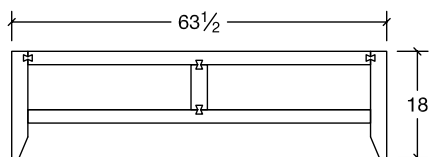

2-51-1502Q
Queen Footboard
63¹/₂w x 18h

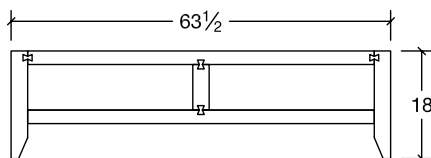

2-51-1501Q
Queen Footboard
63¹/₂w x 18h

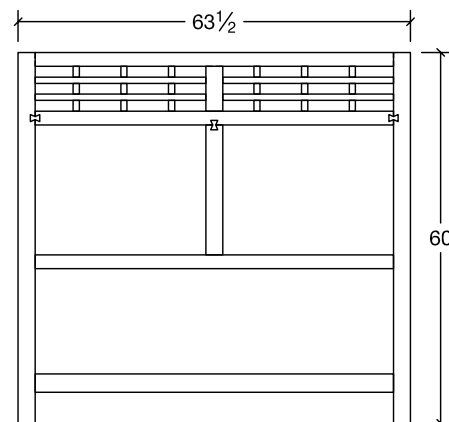

1-51-1501Q
Queen Headboard
63¹/₂w x 60h

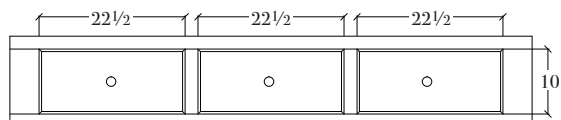

Storage Rail
3 drawer
14h

See pricelist for underbed
storage order info

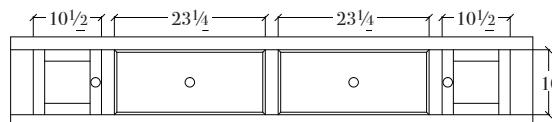

Storage Rail
2 door, 2 drawer
14h

See pricelist for underbed
storage order info



SOMA *Bedroom Collection*

COLLECTION FEATURES

- Mirrors have bevel cut edges
- Constructed with mortise and tenon joints
- Cast dovetailed brackets support mattress
- Dovetailed solid wood drawers
- Chest features a cedar lined drawer bottom
- Dresser features dividers in second row drawers
- Hardware not available on other collections
- Soft close slides

COLLECTION OPTIONS

- Distressed Finish (#2D)
- Hardware Options-See hardware page in Features & Options section
- Underbed Storage Options
- LED nightlight (#LEDN)
- Additional drawer dividers for dressers (#DD)
- Dresser drawer available with felt lined jewelry tray (#SJT)
- Additional cedar lined drawers available (#CB)
- See upholstery book for fabric or leather choice



Shown in Rustic Cherry with 103 Dew Finish

Soma Upholstered Bed
Headboard: 61 1/2"h
Footboard: 18"h
#CSMUKB Cal. King: 80"w x 90"d
#SMUKB King: 84"w x 86"d
#SMUQB Queen: 68"w x 86"d
#SMUFB Full: 62"w x 80"d



Soma Panel Bed
Headboard: 56"h
Footboard: 18"h
#CSMKB Cal. King: 77"w x 91"d
#SMKB King: 81"w x 87"d
#SMQB Queen: 65"w x 87"d
#SMFB Full: 59"w x 81"d



* see underbed storage options
on line drawings page.

SOMA *Bedroom Collection*

CONTINUED...



Soma 3-Drawer Night Stand
#SMNS3
30"w x 17"d x 28"h

Soma Mirror
#SMMR
44 1/2"w x 36 1/2"h



Soma 7-Drawer Dresser
#SMDR66
66 1/4"w x 18"d x 39 3/4"h



Soma Door Chest
#SMDRC
42"w x 19 1/2"d x 52 1/2"h
*2 shelves behind door

Soma 2-Drawer Night Stand
#SMNS2
30"w x 17"d x 28"h



Soma Armoire
#SMAR
37"w x 21 1/2"d x 68"h
Shown in Brown Maple
with #118 Flannel finish
*2 shelves



Soma 1-Drawer Night Stand
#SMNS1
24"w x 16"d x 28"h
Shown in Brown Maple
with #113 Oatmeal finish

SOMA

BEDROOM COLLECTION SPECIFICATIONS

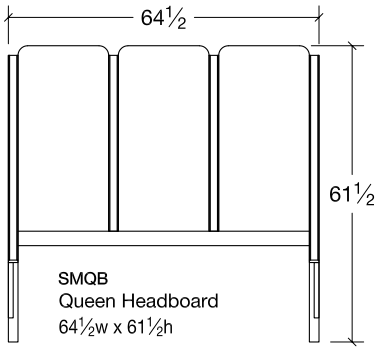

SMQB
Queen Headboard
64 1/2 w x 61 1/2 h

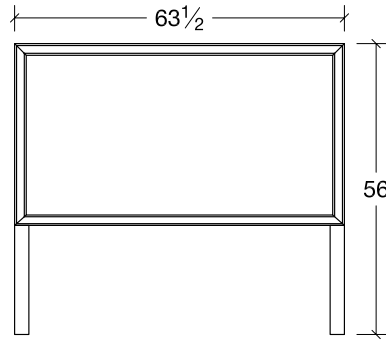

SMQB
Queen Headboard
63 1/2 w x 56 h

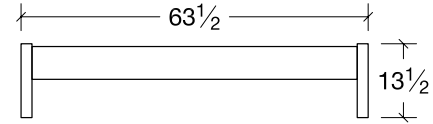

SMQB
Queen Low Footboard
63 1/2 w x 13 1/2 d

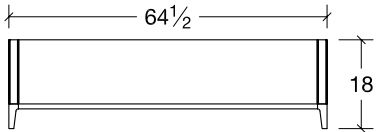

SMQB
Queen Footboard
64 1/2 w x 18 h

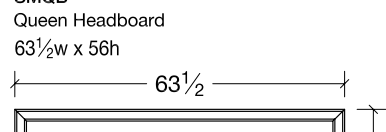

SMQB
Queen Footboard
63 1/2 w x 18 d

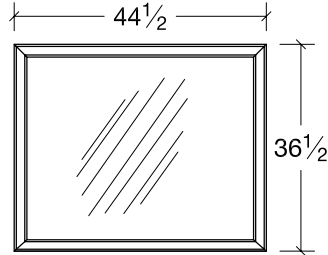

SMMR
Soma Mirror
44 1/2 w x 36 1/2 d

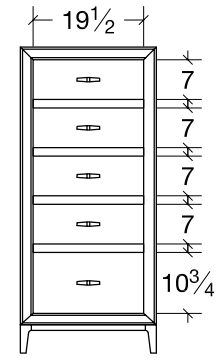

SMLC
Soma Lingerie Chest
5 Drawer
24 w x 16 d x 54 h

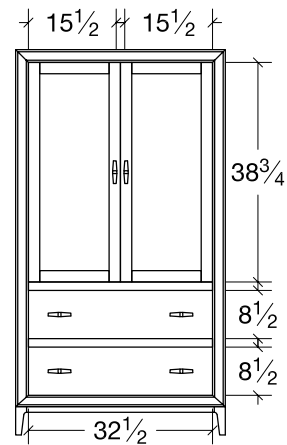

SMAR
Soma Armoire *2 shelves
2 Drawer, 2 Door
37 w x 21 1/2 d x 68 h

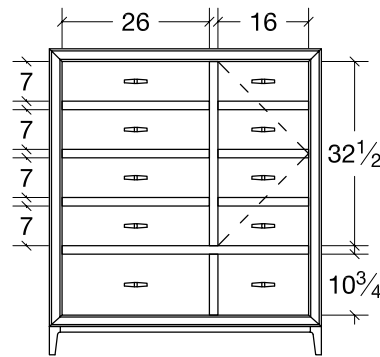

SMDRC
Soma Door Chest *2 shelves behind door
6 Drawers, 1 Door
48 w x 18 1/2 d x 54 h

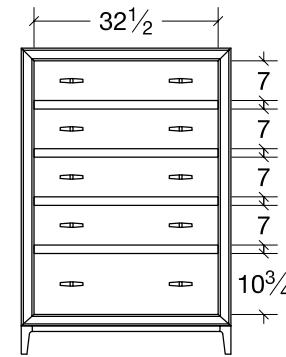

SMCD
Soma Chest
5 Drawer
37 w x 18 1/2 d x 54 h

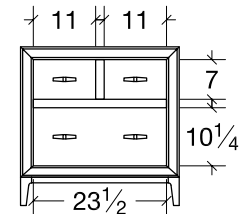

SMNS3
Soma Nightstand
3 Drawer
28 w x 16 d x 28 h

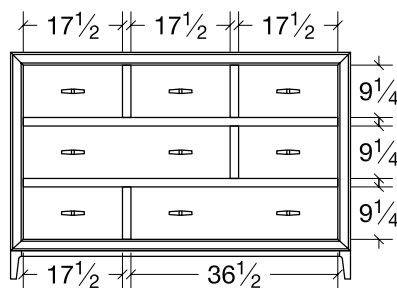

SMDR60
Soma Dresser
7 Drawer
60 w x 18 1/2 d x 40 h

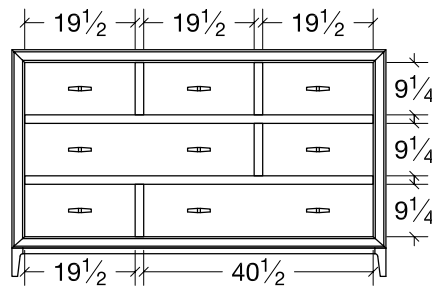

SMDR66
Soma Dresser
7 Drawer
66 w x 18 1/2 d x 40 h

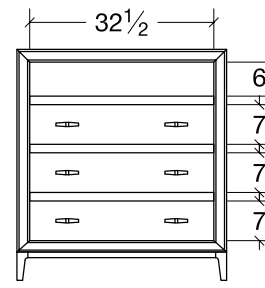

SMMC
Soma Media Chest
3 Drawer
37 w x 18 1/2 d x 40 3/4 h

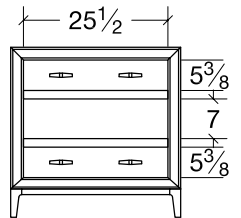

SMNS2
Soma Nightstand
2 Drawer
30 w x 16 d x 30 h

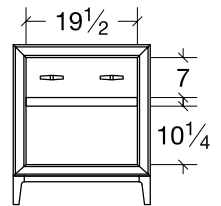

SMNS1
Soma Nightstand
1 Drawer
24 w x 16 d x 28 h

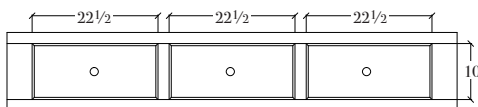

Storage Rail
3 drawer
14h
See pricelist for underbed storage order info

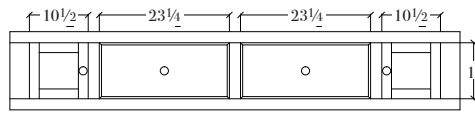

Storage Rail
2 door, 2 drawer
14h
See pricelist for underbed storage order info

VICTOR *Bedroom Collection*

COLLECTION FEATURES

- Live edges on bed & tops
- Mortise & tenon joints
- Dovetailed solid wood drawers
- Soft-close full extension drawers
- Fully framed solid wood case goods
- 1 1/4" thick tops
- Bevel-cut mirror
- Mattress supported with cast dovetail brackets
- Two solid hardwood adjustable shelves on armoire
- Cedar lined bottom drawer on chest
- Dividers in second row drawers on dresser
- Black hardware (not available on other collections)

COLLECTION OPTIONS

- Hardware Options (see Features & Options page)
- Additional adjustable shelf for armoire (#AJS)
- Optional under bed storage unit
- Touch switch LED night light (#LEDN)
- Night Stand available with sliding top, hidden compartment, lock & three-plug power strip (#STP)
- Armoire available with 1 hanger in place of 2 adjustable shelves
- Additional drawer dividers (#DD)
- Dresser drawer available with felt lined jewelry tray (#SJT)
- Additional cedar lined drawers (#CB)
- Docking drawer (#DKD)

See Features & Options section for expectations and details on live edge tops.

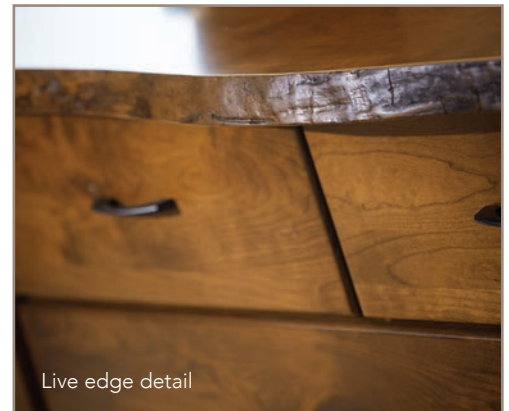



**Victor 2-Drawer
Nightstand**
#VINS
27 1/2"w x 17"d x 28 1/2"h



Victor Bed
Headboard 52"h
Footboard 13 1/2"h
#CVIKB Cal King 76"w x 90 1/2"d
#VIKB King 80"w x 86 1/2"d
#VIQB Queen 64"w x 86 1/2"d
#VIFB Full 58"w x 80 1/2"d
#VITB Twin 43"w x 80 1/2"d



* see underbed storage options
on line drawings page.

VICTOR *Bedroom Collection*

CONTINUED...



Brushed black hardware is exclusive to the Victor Collection



Victor Chest
#VICD
41 1/2" w x 22 1/4" d x 53" h



Victor 48" Mirror
#VIMR48
48" w x 32" h



Victor 7-Drawer Dresser
#VI7DR66
67 1/2" w x 22 1/4" d x 36" h

VICTOR

BEDROOM COLLECTION SPECIFICATIONS

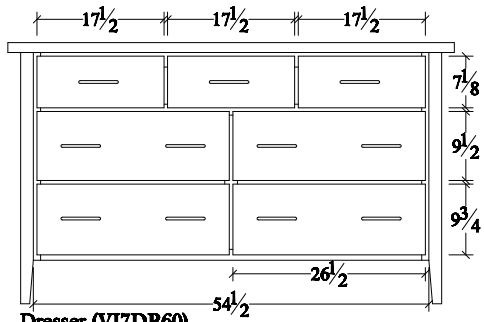

Dresser (VI7DR60)
7 drawer
61 1/2 w x 22 1/4 d x 36h

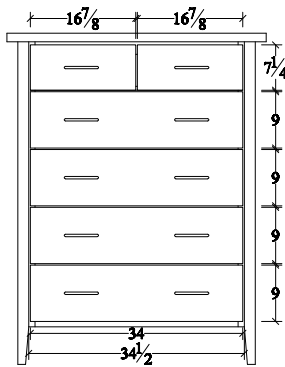

Chest (VICD)
6 Drawer
42 1/2 w x 22 1/4 d x 53h

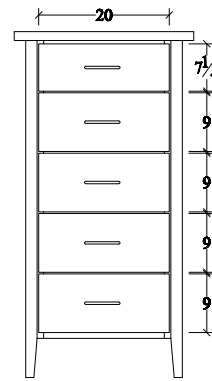

Lingerie Chest (VILC)
5 drawer
27 1/2 w x 17d x 53h

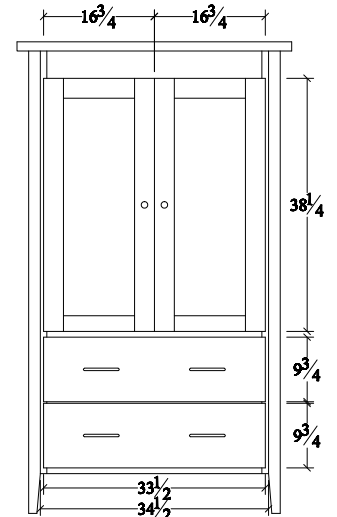

Armoire (VIAR)
2 drawer, 2 door
41 1/2 w x 22 1/4 d x 71 1/4 h
*2 shelves

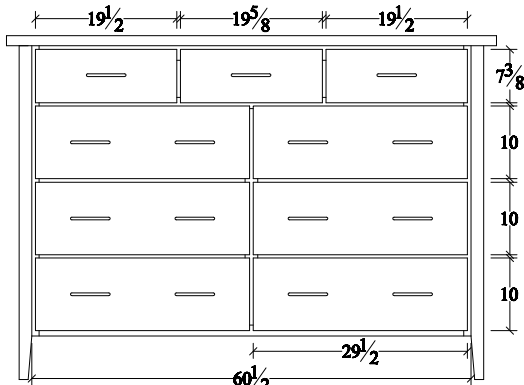

Dresser (VIDR9)
9 drawer
67 1/2 w x 22 1/4 d x 46h

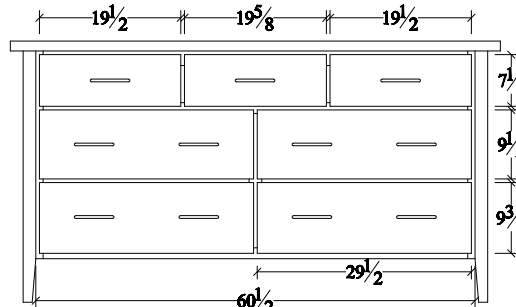

Dresser (VI7DR66)
7 drawer
67 1/2 w x 22 1/4 d x 36h

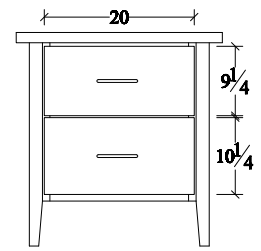

Nightstand (VINS)
2 drawers
27 1/2 w x 17d x 28 1/2 h

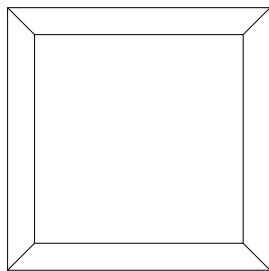

Mirror (VIMR42)
42w x 42h

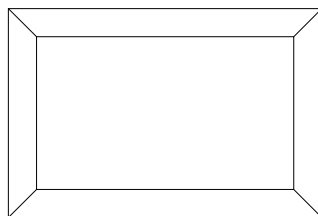

Mirror (VIMR32)
48w x 32h

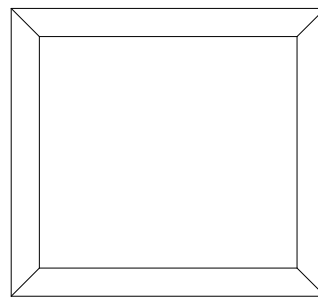

Mirror (VIMR48)
48w x 44h

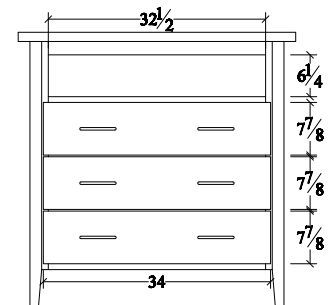

Media Chest (VIMC)
3 drawer, 1 opening
42 1/2 w x 22 1/4 d x 41 1/2 h

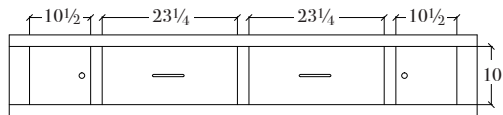

Storage Rail
2 door, 2 drawer
14h
See pricelist for underbed storage order info.

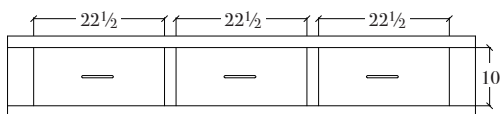

Storage Rail
3 drawer
14h

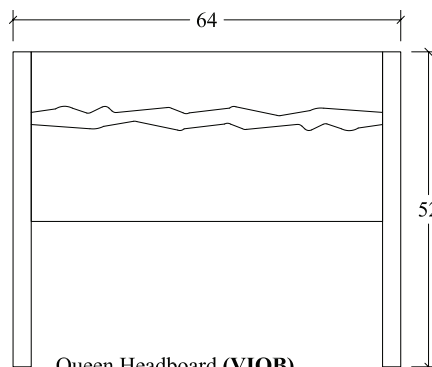

Queen Headboard (VIQB)
64w x 52h

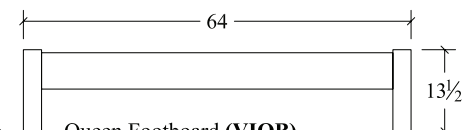

Queen Footboard (VIQB)
64w x 13 1/2h

WOODROW *Bedroom Collection*

COLLECTION FEATURES

- Cove-cut drawer fronts
- Mirrors have bevel cut edges
- Constructed with mortise and tenon joints
- Cast dovetailed brackets support mattress
- Dovetailed solid wood drawers
- Soft-closing full extension undermount drawer guides
- Chest features a cedar lined drawer bottom
- Dresser features dividers in second row drawers
- Nickel Hardware, not available on other collections

COLLECTION OPTIONS

- Distressed Finish (#2D)
- Hardware Options
(see Features & Options page)
- Underbed Storage Options
- LED nightlight (#LEDN)
- Docking drawer with power (#DKD)
- Additional drawer dividers for dressers (#DD)
- Dresser drawer available with felt lined jewelry tray (#SJT)
- Additional cedar lined drawers available (#CB)



Woodrow 3 Drawer Nightstand

#WWNS3

26"w x 16 1/2"d x 29"h



Brown Maple with #99 Toffee Finish



Woodrow Chest
#WWCD
38" w x 19" d x 52" h



**Woodrow
60" Dresser Mirror**
#WWMR
42 1/2" w x 39" h

Woodrow 60" Dresser
#WWDR60
60" w x 19" d x 38" h



Woodrow Bed
Headboard 60" h
Footboard 18" h
#WWCKB Cal. King Bed 76" w x 90" d
#WWKB King Bed 80" w x 86" d
#WWQB Queen Bed 63" w x 86" d
#WWFB Full Bed 58" w x 80" d
#WWTB Twin Bed 43" w x 80" d

* see underbed storage options
on line drawings page.

WOODROW

BEDROOM COLLECTION SPECIFICATIONS

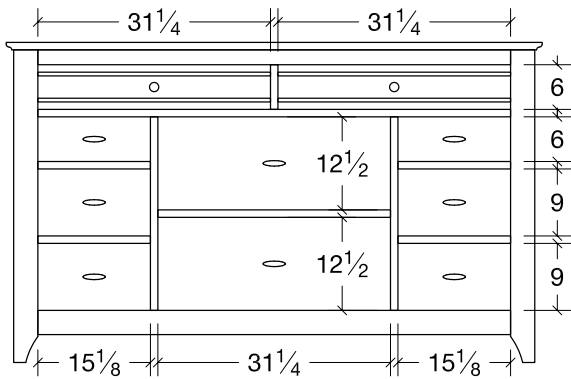

Dresser (WWDR72)
10 drawer
72w x 19d x 43h

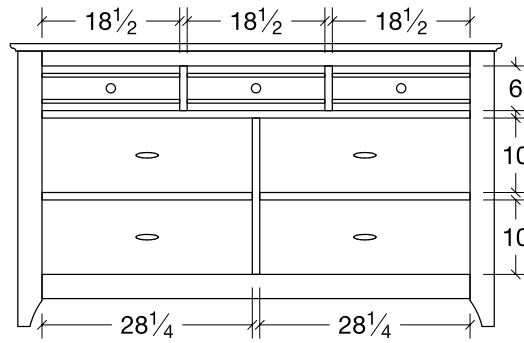

Dresser (WW7DR66)
7 drawer
66w x 19d x 38h

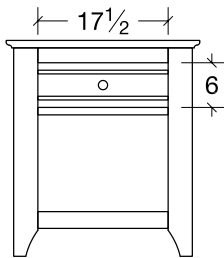

Night Stand (WWNS1)
1 drawer
26w x 16 1/2d x 29h

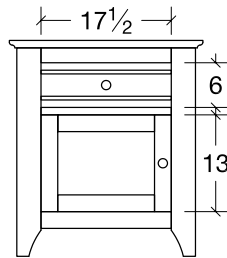

Night Stand (WWNSIDL)
1 drawer, 1 door
26w x 16 1/2d x 29h

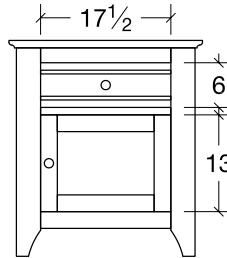

Night Stand (WWNSIDR)
1 drawer, 1 door
26w x 16 1/2d x 29h

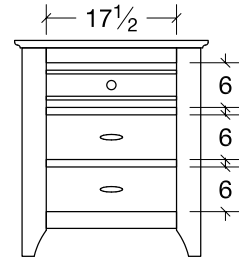

Night Stand (WWNS3)
3 drawer
26w x 16 1/2d x 29h

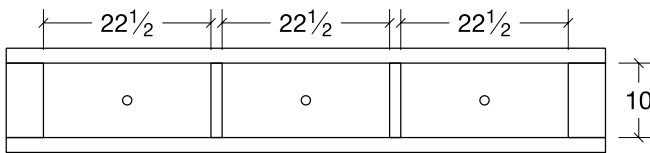

Storage Rail, King and Queen
3 drawer
80 1/2w x 14h

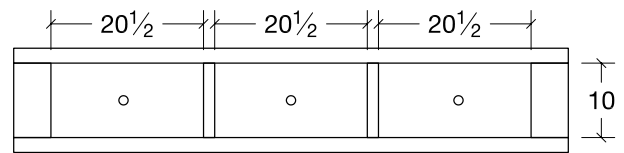

Storage Rail, Full
3 drawer
74 1/2w x 14h

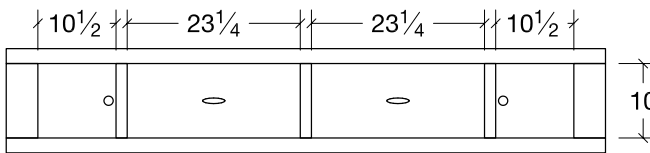

Storage Rail, King and Queen
2 drawer, 2 door
80 1/2w x 14h

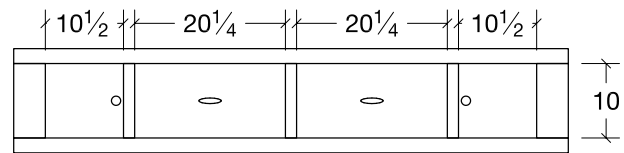

Storage Rail, Full
2 drawer, 2 door
74 1/2w x 14h

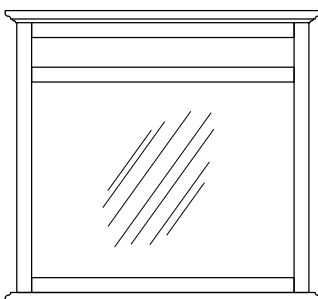

Mirror (WWMR)
42 1/2w x 39h

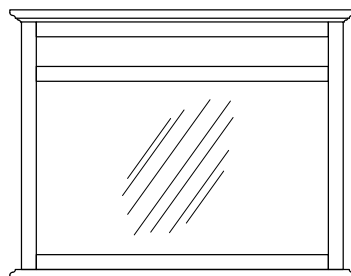

Mirror (WWMR46)
46w x 36h

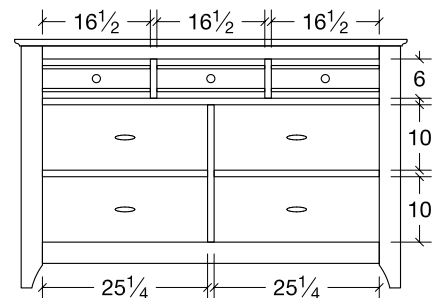

Dresser (WWDR60)
7 drawer
60w x 19d x 38h

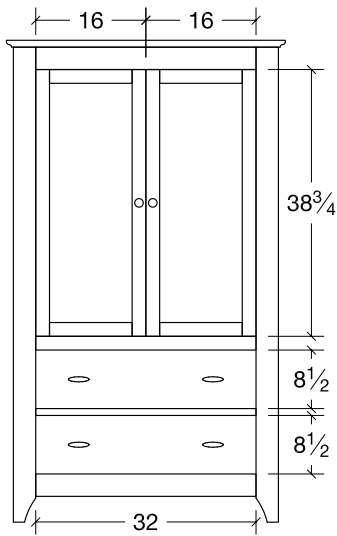

Armoire (WWAR) *2 shelves
2 drawer, 2 door
40 1/2w x 22d x 70h

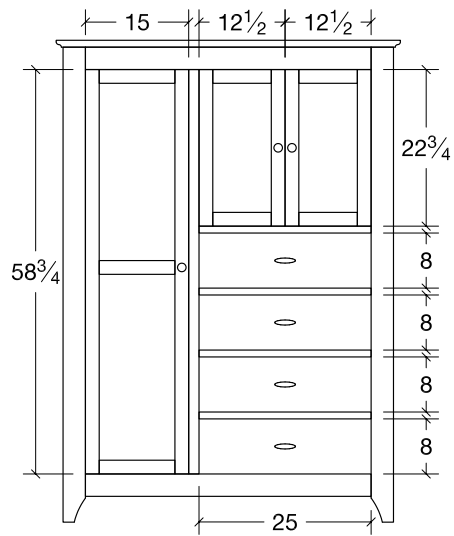

Chifferobe (WWCB) *1 shelf behind small doors
4 drawer, 3 door
50w x 22d x 70h
*3 shelves and 1 rod behind long door

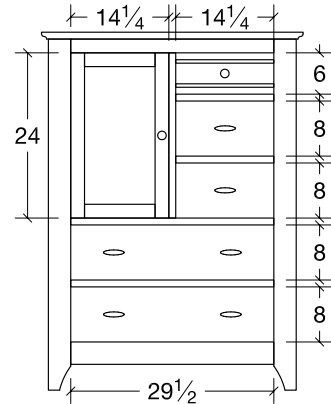

Door Chest (WWDR) *1 shelf behind door
5 drawer, 1 door
38w x 19d x 52h

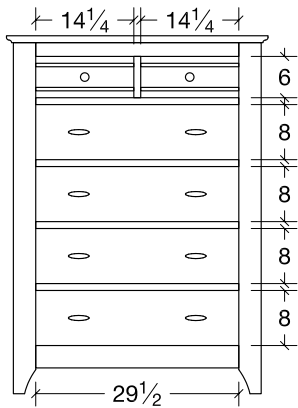

Chest (WWCD)
6 drawer
38w x 19d x 52h

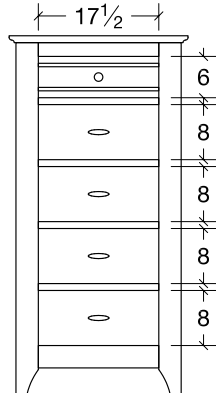

Lingerie Chest (WWLC)
5 drawer
26w x 16 1/2d x 52h

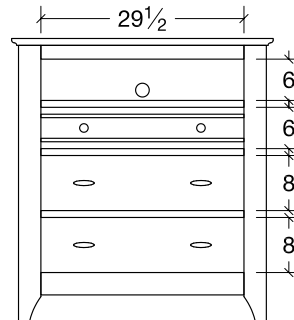

Media Chest (WWMC)
3 drawer
38w x 19d x 41h

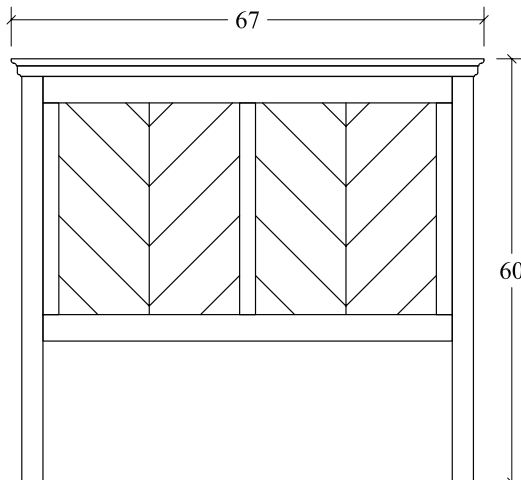

Queen Headboard (WWQB)
67w x 60h

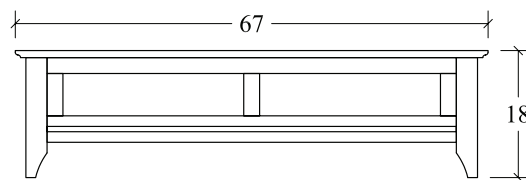

Queen Footboard (WWQB)
67w x 18h

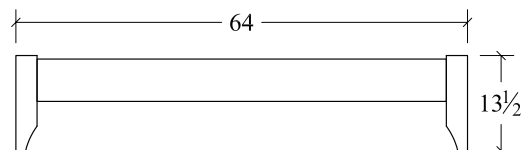

Queen Low Footboard (WWQB)
64w x 13 1/2h

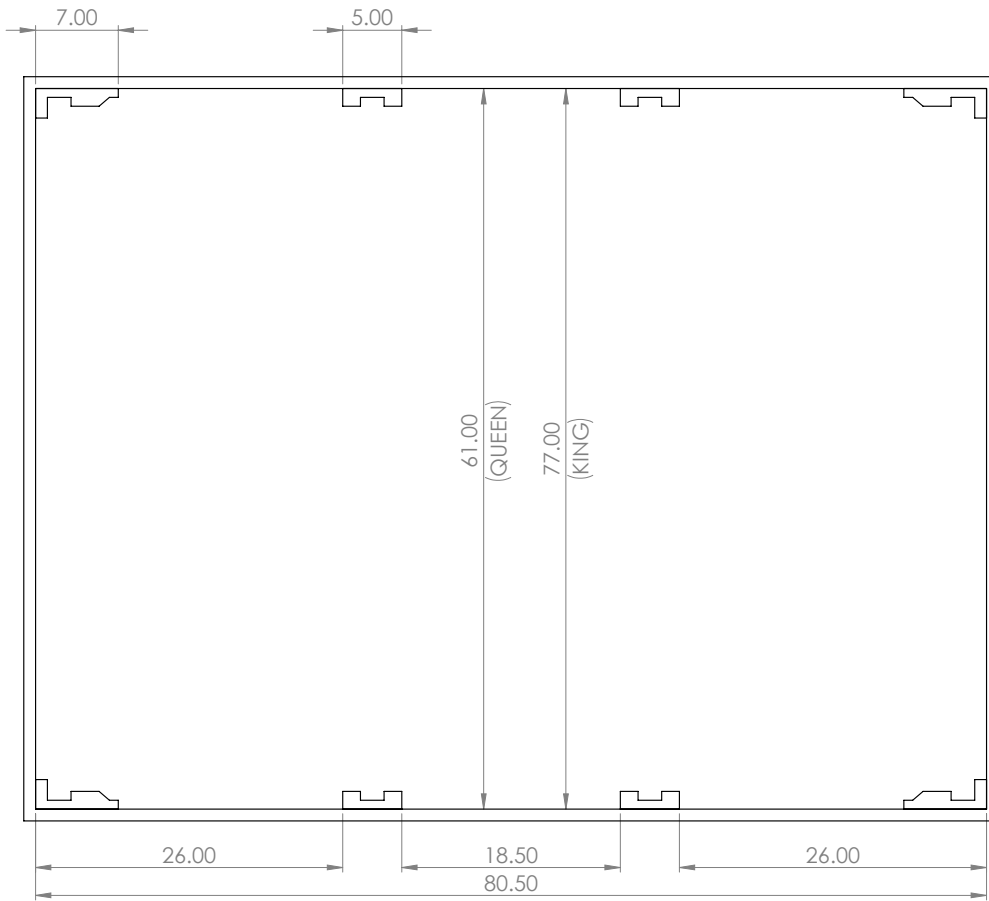

Beds can accommodate adjustable bed frames. See drawing to confirm dimensions.

All bedroom storage rails are only available with sidemount slides







**YOU'LL ADMIRE THE BEAUTY. YOU'LL
APPRECIATE THE VALUE. YOU'LL LOVE THE
LOOK!**

Fusion Designs continues to grow and add to the unique diversity of styles we offer in order to satisfy the most discriminating of shoppers. We're all about the details, start to finish. By selecting only the finest woods and quality hardware, our woodcrafters utilize the best-proven construction techniques to create furniture that is as durable as it is beautiful. Each piece is individually crafted, not mass produced. Our desire is to provide you with the highest quality furniture at the best value. Construction features like these set us apart...compare the integrity, compare the details.