

2024



West Point 
WOODWORKING LLC



TABLE OF CONTENTS

New & Discontinued Products	6	Collections	18-21
Single Pedestal Tables	8	Excellent Sellers	22
Double Pedestal Tables	9	Ordering Information	23
Leg Tables	10	Warranty	23
Trestle Tables	11	Attention To Details	24
Stationary Base Tables	12	Table Options	25
Cabinet Base Tables	12	Information	26
Benches	13	Self Store	27-29
Butterfly Tables	14-16	Locks	30
Quickship Items	17		

TABLES

Addison Single	31	Bridgeport	43
Advance Single	31	Brinkley Trestle	44
Alana Single	32	Broadway Leg	45
Albany	32	Brooklyn Single	46
Arts & Crafts	33	Brookville	46
Arts & Crafts Cabinet	33	Brookville Pub	47
Arts & Crafts Pub	34	Burlington Single	48
Arts & Crafts Trestle	34	Cambridge	49
Avery Trestle	36	Canterbury Leg	50
Barrington Double	35	Carson Single	51
Barrington Single	37	Chancellor Double	52
Bassett Cabinet	37	Chancellor Single	53
Baytown Double	38	Chesapeake Trestle	53
Baytown Single	39	Cheyenne Leg	54
Berkshire	40	Colebrook	56
Braden Trestle	41	Columbus Trestle	57
Brady Leg	43	Dallas Trestle	58
		Dayton Leg	59

TABLE OF CONTENTS (continued)

Denver Leg.	60	Laurie's	85
Dover Leg.	61	Lexington Leg Mini	86
Dutch Double.	62	Lexington Leg	87
Easton Single	62	Lexington Single Mini	88
El Dorado Trestle.	63	Lexington Single	89
El Paso Trestle	65	Lexington Cabinet.	90
Ellianna Leg	66	Lexington Trestle.	90
Ethan.	66	Lifestyle Trestle	91
Fenway Trestle Pub	67	Logan Trestle	92
Fremont Trestle	67	Madison Pub	93
Fulton Trestle.	68	Mankato Trestle.	94
Galena Trestle	69	Mansfield	95
Hampton	70	Martin Trestle Pub.	95
Hampton Leg.	71	McCoy	96
Harrison Double.	72	Mission Leg	97
Harrison Single.	72	Mission Trestle.	97
Hartford Trestle	73	Naperville Trestle	98
Harvest Leg	74	Nashville Trestle	99
Heidi Cabinet.	75	Newbury.	100
Heidi Leg	76	Olde Century Mission	102
Imperial Single.	77	Orewood Trestle	103
Imperial Double.	79	Oxford Double.	104
Imperial Single Pub	78	Pagosa Trestle	105
Jamestown.	80	Plymouth Leg Drop Leaf.	106
Kingsbury Mission Trestle.	80	Portland Single	106
Kingsley Single.	81	Preston Double	107
Knoxville Trestle.	82	Preston Single	107
Lamesa Trestle.	82	Ravena Trestle	108
Laporte Trestle.	83	Reno Trestle	109
Laredo Trestle	84	Richland Trestle	110

TABLE OF CONTENTS (continued)

Ridgecrest	110	Traditional Leg.	119
Ridgewood.	111	Traditional Pub.	119
Santa Fe Leg	112	Traditional Scallop.	120
Saratoga Trestle.	113	Traditional Single.	120
Savannah Single.	114	Tulsa Cabinet.	121
Shelby Trestle	114	Vancouver Trestle	122
Sheridan Trestle.	116	Wabash Barrel	123
Sierra.	117	Wellington Trestle	124
Sonoma Single.	117	Westin.	125
Stanwood.	118	Xavier Trestle	126
Traditional Double.	118		

BENCHES

Arts & Crafts Bench	35	Heidi Bench	77
Braden Bench.	41	Laporte Bench	83
Bridgeport Bench	42	Laredo Bench.	84
Broadway Bench	45	Lexington Bench	91
Cambridge Bench	49	Lifestyle Bench.	92
Canterbury Bench	51	Logan Bench	93
Chesapeake Bench	54	Mankato Bench	94
Cheyenne Bench	55	McCoy Bench.	96
Colebrook Bench.	55	Mission Bench	98
Columbus Bench	58	Nashville Bench	99
Denver Bench.	59	Newbury Bench	100
El Dorado Bench	64	Olde Century Bench	102
El Paso Bench.	64	Pagosa Bench	105
Galena Bench.	70	Reno Bench	108
Hampton Bench.	71	Santa Fe Bench	111
Harvest Bench	74	Sheridan Bench	116
		Xavier Bench	125

NEW PRODUCTS FOR 2024



Alana Single



Braden Trestle



Brinkley Trestle



Ellianna Leg



Fenway Trestle Pub



Martin Trestle Pub



Plymouth Leg Drop Leaf



Sonoma Single



Braden Bench



Logan Bench



Nashville Bench



Pagosa Bench

DISCONTINUED PRODUCTS



Paris Trestle



Rio Vista Trestle



Saratoga Single



Paris Bench



Rio Vista Bench

WOOD & HUMIDITY

The photos below are examples of what can happen to a table with humidity changes. This is not a defect, it is the result of natural movement in wood. Please see page 23 for more information regarding wood movement.

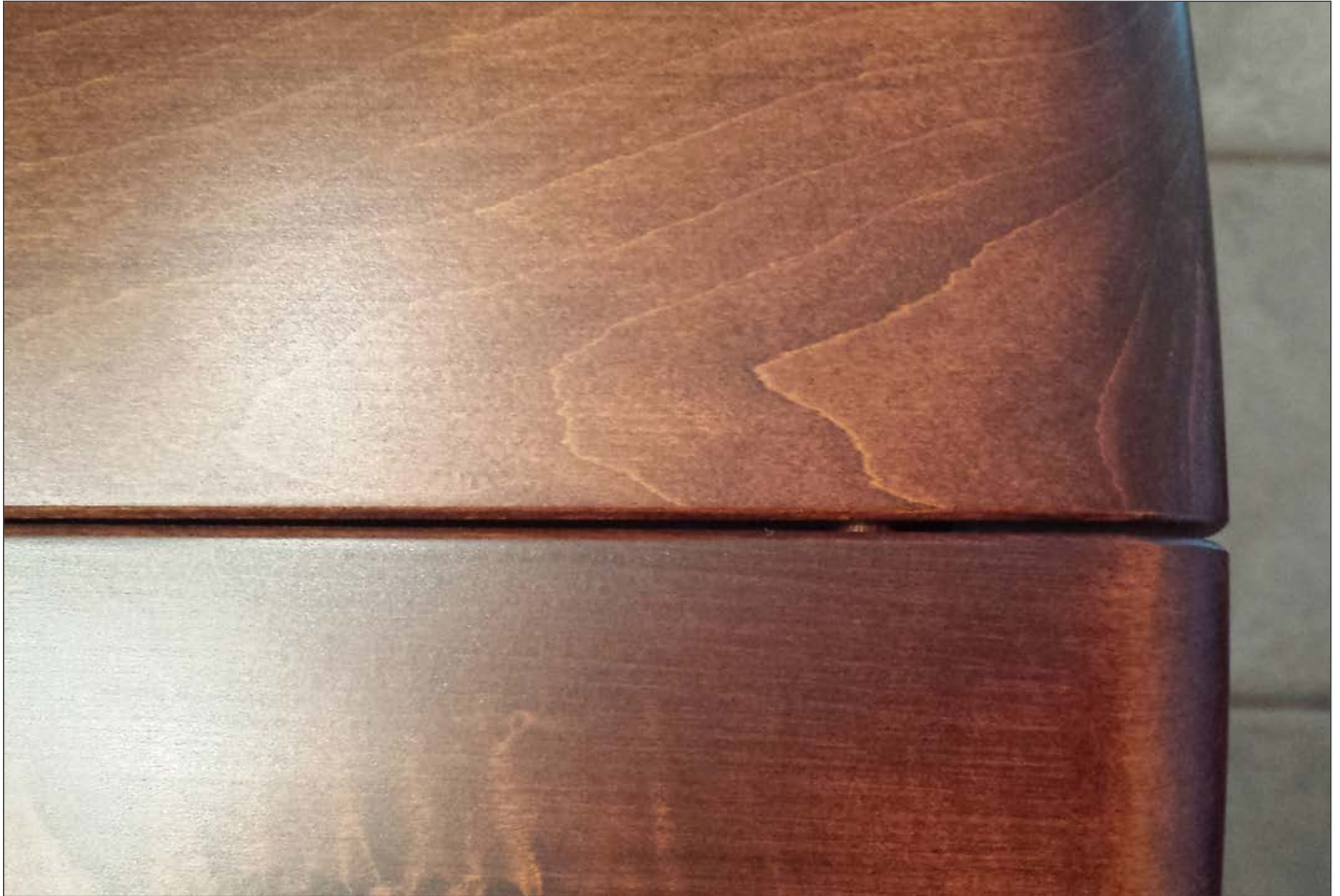

The photo above is the result of too low humidity, creating a gap at the ends of the joints. If the humidity is too high, the table will gap at the center of the joints.

SINGLE PEDESTAL TABLES



Addison Single



Advance Single



Albany



Alana Single



Barrington Single



Baytown Single



Brooklyn Single



Burlington Single



Carson Single



Chancellor Single



Easton Single



Harrison Single



Kingsley Single



Lexington Single



Lexington Single Mini



Portland Single



Preston Single



Ridgewood



Savannah Single



Sonoma Single



Traditional Pub



Traditional Single



Wabash Barrel



Westin

DOUBLE PEDESTAL TABLES



Barrington Double



Baytown Double



Chancellor Double



Dutch Double



Harrison Double



Oxford Double



Preston Double



Traditional Double



Traditional Scallop

LEG TABLES



Berkshire



Brady Leg



Broadway Leg



Canterbury Leg



Cheyenne



Dayton Leg



Denver Leg



Dover Leg



Ellianna Leg



Ethan



Hampton Leg



Harvest Leg



Heidi Leg



Laurie's



Lexington Leg



Lexington Leg Mini



Madison Pub



Mansfield



Mission Leg



Newbury



Plymouth Leg Drop Leaf



Santa Fe Leg



Stanwood



Traditional Leg

TRESTLE TABLES



Arts & Crafts Trestle



Avery Trestle



Braden Trestle



Bridgeport



Brinkley Trestle



Cambridge



Chesapeake



Colebrook



Columbus Trestle



Dallas



El Dorado



El Paso Trestle



Fenway Trestle Pub



Fremont Trestle



Fulton Trestle



Galena Trestle



Hampton



Hartford Trestle



Jamestown



Kingsbury Mission



Knoxville Trestle



Lamesa Trestle



Laporte Trestle



Laredo Trestle



Lexington Trestle



Lifestyle Trestle



Logan Trestle



Mankato Trestle



Martin Trestle Pub



McCoy



Mission Trestle



Naperville Trestle



Nashville Trestle



Olde Century Mission



Orewood Trestle



Pagosa Trestle



Ravena Trestle



Reno Trestle



Richland Trestle



Saratoga Trestle



Shelby Trestle



Sheridan Trestle



Sierra



Vancouver



Wellington Trestle



Xavier Trestle

STATIONARY BASE TABLES



Arts & Crafts



Arts & Crafts Pub



Brookville



Brookville Pub



Imperial Double



Imperial Single



Imperial Single Pub



Ridgecrest

CABINET BASE TABLES



Arts & Crafts Cabinet



Bassett Cabinet



Heidi Cabinet



Lexington Cabinet



Tulsa Cabinet

BENCHES



Arts & Crafts Bench



Braden Bench



Bridgeport Bench



Broadway Bench



Cambridge Bench



Canterbury Bench



Chesapeake Bench



Cheyenne Bench



Colebrook Bench



Columbus Bench



Denver Bench



El Dorado Bench



El Paso Bench



Galena Bench



Hampton Bench



Harvest Bench



Heidi Bench



Laporte Bench



Laredo Bench



Lexington Bench



Lifestyle Bench



Logan Bench



Mankato Bench



McCoy Bench



Mission Bench



Newbury Bench



Nashville Bench



Olde Century Bench



Pagosa Bench



Reno Bench



Santa Fe Bench



Sheridan Bench



Xavier Bench

BUTTERFLY LEAF TABLES

LEG TABLES

- For pricing on butterfly leaf tables, see page 4 of price list
- Leg tables available with only one 18" butterfly leaf
- 42" is minimum width for butterfly leaf table
- Not available with 4" Clip Corner top shape
- Butterfly leaf tables are not available in custom widths
- Maximum leaf width is 18"



Broadway Leg



Canterbury Leg



Denver Leg



Heidi Leg



Madison Pub



Mansfield



Mission Leg



Newbury



Traditional Leg

CABINET BASE TABLES

- Cabinet base tables are standard with 1–18" butterfly leaf
- Cabinet base tables are not available with 2 butterfly leaves



Arts & Crafts Cabinet



Bassett Cabinet



Heidi Cabinet



Lexington Cabinet

BUTTERFLY LEAF TABLES

TRESTLE TABLES

- For pricing on butterfly leaf tables, see page 4 of price list
- See page 24 for close-up view of a Butterfly Table
- 42" x 60" & 48" x 60" 1-18" butterfly leaf only due to short base
- 42" x 66", 42" x 72", 48" x 66", & 48" x 72" available with one or two 18" butterfly leaves
- 42" is minimum width for butterfly leaf table
- Butterfly leaf tables are not available in custom widths
- Maximum leaf width is 18"



Arts & Crafts Trestle



Brinkley Trestle



Cambridge



Colebrook



Fremont Trestle



Galena Trestle



Jamestown



Kingsbury Mission



Lexington Trestle



McCoy



Mission Trestle



Naperville Trestle



Nashville Trestle



Olde Century Mission



Ravena Trestle



Reno Trestle



Richland Trestle



Sierra



Vancouver Trestle

BUTTERFLY LEAF TABLES

SINGLE PEDESTAL TABLES

- For pricing on butterfly leaf tables, see page 4 of price list
- Single pedestal tables available with only one 18" butterfly leaf
- Only available in 48" and 54" round
- Not available in custom sizes
- Only available in 18" leaf
- Only available with 1" thick top
- Leaf skirts not available



Alana Single



Albany



Arts & Crafts



Arts & Crafts Pub



Baytown Single



Brookville



Brookville Pub



Carson Single



Chancellor Single



Easton Single



Harrison Single



Imperial Single



Imperial Single Pub



Lexington Single



Portland Single



Preston Single



Ridgewood



Savannah Single



Traditional Single

QUICKSHIP ITEMS

- These items are available in Quickship
- *NOTE: the edge, shape and S/S options cannot be changed on Quickship items*
- We reserve the right to remove any item from the Quickship program without prior written notice
- **NEW options: Columbus table & bench, Galena 42"x72" in Rustic Hickory**



Baytown Single
42" Round, 2 leaf
Brown Maple



Burlington Single
60" Round Solid Top
Brown Maple or Rustic
Cherry



Columbus Bench
72", 2 leaf
Rough Sawn
Wormy Maple



Columbus Trestle
42"x72", 2 leaf, S/S
Rough Sawn
Wormy Maple



Denver Leg
42"x72", 2 leaf, S/S
Oak



Dover Leg
36"x48", 2 leaf, S/S
Oak or Brown Maple



El Paso Bench
80", 2 leaf
Rough Sawn
Wormy Maple



El Paso Trestle
48"x80", 2 leaf
Rough Sawn
Wormy Maple



Galena Trestle
42"x72", 2 leaf, S/S, QSWO
42"x72", 2 leaf, S/S, R. Hickory
48"x72", 4 leaf, S/S, QSWO



Imperial Single
48" Round, 2 leaf
Brown Maple



Lexington Leg
42"x72", 2 leaf, S/S
Brown Maple



Lexington Single
54" Round, 2 leaf
Brown Maple



Newbury Leg
42"x60", 2 leaf, S/S
Brown Maple



Sheridan Trestle
36"x54", 2 leaf, S/S
Oak



Xavier Bench
84" Solid Top
Rustic Walnut



Xavier Trestle
42"x84" Solid Top
Rustic Walnut

COLLECTIONS



Avery - pg. 36



Baytown Double - pg. 38



Baytown Single - pg. 39



Berkshire - pg. 40



Bridgeport - pg. 43



Burlington Single - pg. 48



Canterbury Leg - pg. 50



Chancellor Double - pg. 52

COLLECTIONS



Colebrook - pg. 56



Columbus Trestle - pg. 57



Denver Leg - pg. 60



Dover Leg - pg. 61



El Dorado Trestle - pg. 63



El Paso Trestle - pg. 65



Galena Trestle - pg. 69



Heidi Cabinet - pg. 75

COLLECTIONS



Heidi Leg - pg. 76



Imperial Double - pg. 79



Kingsley Single - pg. 81



Laredo Trestle - pg. 84



Lexington Leg - pg. 87



Lexington Single - pg. 89



Newbury - pg. 101

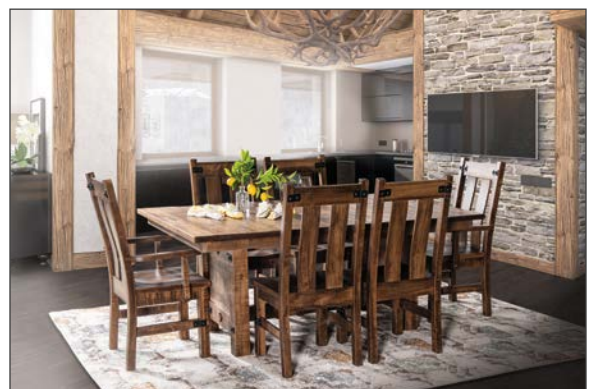

Orewood Trestle - pg. 103

COLLECTIONS



Reno Trestle - pg. 109



Santa Fe Leg - pg. 112



Saratoga Trestle - pg. 113



Sheridan Trestle - pg. 115



Tulsa Cabinet - pg. 121



Wabash Barrell - pg. 123



Wellington Trestle - pg. 124



Xavier Trestle - pg. 126

EXCELLENT SELLERS



Arts & Crafts



Baytown Double



Baytown Single



Broadway Leg



Brookville



Burlington Single



Canterbury Leg



Colebrook Trestle



Denver Leg



Dover Leg



El Paso Trestle



Ethan Leg



Galena Trestle



Heidi Leg



Imperial Double



Imperial Single



Lexington Leg



Lexington Single



Mission Trestle



Newbury



Olde Century Mission



Saratoga Trestle



Sheridan Trestle



Traditional Single



Xavier Trestle

THE NATURE OF WOOD

Wood is a product of nature and therefore acts in ways beyond human control. All hardwood has variation in its color and grain. These wood characteristics will put their own unique touch to each piece of solid wood furniture. Even though we go through the same building process, no two pieces will be exactly the same. Wood color can vary a lot depending on stain selection.

Most hardwoods are open grained, causing solid wood furniture to expand and contract with changes in temperature and humidity, even after protective finishes have been applied. These temperature changes may cause the wood to crack or have surface checks. This is not abnormal and these are

not considered as flaws, but rather nature's "beauty marks" which make each piece manufactured at West Point Woodworking a truly unique piece of furniture.

Indoor humidity should be kept in the 35-40% range to minimize these effects. Solid wood should be kept away from direct sources of heating and cooling and should not be stored in attics or basements. Direct sunlight and fluorescent fixtures that contain ultraviolet rays can cause chemical changes in wood and finish and therefore should be avoided.

When cared for properly your solid wood furniture will become a piece of timeless beauty, one that will be treasured for generations.

ORDERING INFORMATION

To avoid delays in production and unnecessary phone calls, please provide the following information on all table orders.

1. QUANTITY
2. STYLE
3. SIZE
4. LEAVES: with skirts or without skirts
5. SHAPE OF TOP: if options are available
6. EDGE STYLE: if the shape of top or edge is not specified, we will proceed with the standard specs for that style
7. BASE STYLE: single pedestal, double pedestal, leg
8. FEET STYLE: if options are available
9. SELF STORE: if available
10. WOOD SPECIE
11. STAIN COLOR: if available at time of order
12. YOUR PURCHASE ORDER NUMBER
13. CUSTOMER NAME
14. YOUR FINISHER...so we know where to ship your tables!

Thank You!

WARRANTY POLICY

At West Point Woodworking we are pleased that you have chosen to invest in hardwood furniture. Our tables are built entirely out of hardwoods from the top to bottom. You will not find any particle board or veneers, with the exception of some parts of the cabinet base. We use some plywood in places where it would not be practical to use solid hardwoods due to expansion and contraction of solid wood. We offer a two year warranty on workmanship, materials, and construction methods. If a defect is found in the first two years of when the table was built, and the table has not been abused or improperly cared for, we will repair the table at no cost. If the table has been damaged due to improper care we can still repair the table and will do so at a reasonable fee (usually \$60 or less depending on damage).

Always keep in mind that wood is a natural product and can expand or contract under certain humidity conditions. When the humidity is too high (above 50%) you may see some gaps between the leaves toward the center of the table. If the humidity level drops below 35% you may notice a little gap between the leaves towards the outer edge of the leaves. Most of the time this is nothing to be alarmed about and you may see the table go through this as the seasons change, especially if the house is not humidity controlled. If there is enough expansion or contraction in the table top to actually cause the wood to split, we will repair the table in the first two years unless it was improperly cared for. Finishing and shipping back and forth for repairs is not included in the warranty. If the table splits after two years from the manufacturing date, there will be a minimum charge of \$35 to repair the table and send it to the finish shop. Finishing cost will have to be negotiated between the retail store and the finisher.

ATTENTION TO DETAILS

West Point Woodworking pays attention to special details. Quality and details are important to us. Quality standards are established to ensure trouble free service. Each table is made-to-order and our craftsmen will follow your specifications from start to finish.

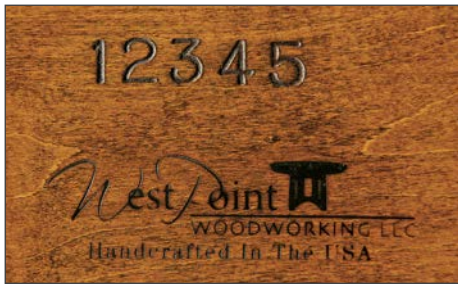

Each table is assigned a serial number for tracking purposes should any questions or problems arise.

V-grooved corner block assembly and two bolt leg attachments are part of the quality construction of our tables.

Quarter Sawn is created by using a different sawing technique to expose the different grains in the wood bringing out the flakes that remind us of family heirlooms.



Self-storing tables are designed to conveniently store extra leaves. Quality gear slides are used to help you open your table easily.



Butterfly leaf table option. See pages 14 – 16 for available styles.

OPTIONS

TABLE EDGE DESIGNS



Roundover (5/8")



Bevel



Mission (1/8" Roundover)



Chamfer



Ogee



Waterfall

TABLE TOP OPTIONS

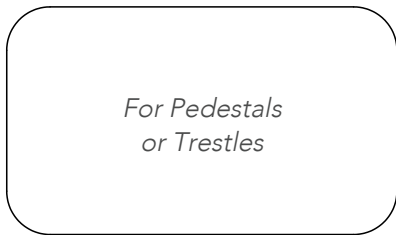

*For Pedestals
or Trestles*

8" SQUARE
ROUND

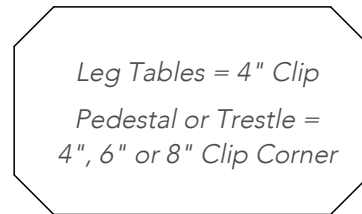

*Leg Tables = 4" Clip
Pedestal or Trestle =
4", 6" or 8" Clip Corner*

CLIPPED
CORNERS

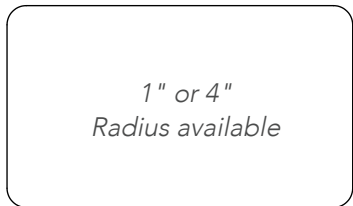

*1" or 4"
Radius available*

RADIUS
CORNER

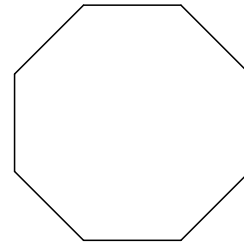

OCTAGON



*Not Available
on Leg Tables*

OVAL

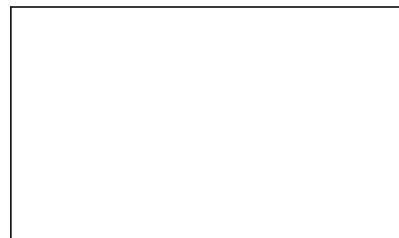

RECTANGLE



*Not Available
on Leg Tables*

BANQUET



BOW
END

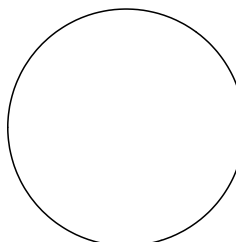

ROUND

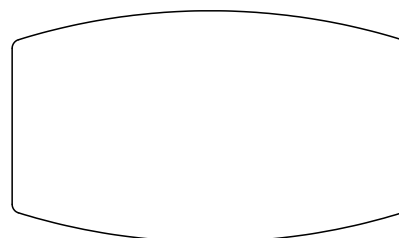

BOAT

INFORMATION

INTERNET POLICY

We require a minimum markup on the **West Point Finished Wholesale price list**. Please see our pricelist for more details.

We firmly believe that the products we are building are far superior to many of the imports and other cheap lines of furniture that are on the market today, and by selling at too low price devalues this level of craftsmanship.

We are pleased that you have chosen to represent our 100% American made products and ask that you promote these products with confidence and truly believe in the product and sell it for what it is worth.

Steve Raber



CARE OF SOLID WOOD TABLES

If cared for properly your solid hardwood table can give you a lifetime of service and beauty. Here are several care tips that will enhance your solid hardwood table investment:

- Place your table away from radiators, fireplaces, and heating ducts.
- Position table out of direct sunlight or adjust blinds to avoid hour after hour of direct sunlight.
- Control humidity to 40%–45%. In winter use a humidifier, in summer use a dehumidifier or air conditioner.
- Use coasters with non-scratching bottoms.
- Use padding under all sharp, hot, or cold objects.
- Store table leaves in close proximity to table or in the same humidity, avoid storing leaves in damp basements where the leaves may swell.
- Avoid using nail polish remover, alcohol, and other solvents near or on table.

ROUTINE CLEANING AND CARE

DUST CAREFULLY with a soft cloth, following the grain pattern of the wood. Use an old T-shirt, baby diaper or cheesecloth that has been laundered to remove the sizing.

DUST OFTEN to remove everyday abrasive particles from wood surfaces.

CONSIDER CLEANING with a mild nonalkaline soap and water. Use the suds in a damp sponge or cloth, but be sure to pre-test the solution on an out-of-sight section to make sure it doesn't damage the finish. Dry immediately with a soft cloth and buff lightly, following the grain.

DON'T WAX or use any polish that contains any silicones! Catalyzed heat and moisture resistant finishes don't need additional polish, but if you want to use a polish we recommend Guardsman Furniture Polish.

REAL OR IMITATION?

Not sure if you're buying solid hardwood or a chip imitation? A check point is the glue joints. Put your finger on a glue joint and trace it along the top of the surface, over the edge, and to the underside. If the line disappears its probably an imitation. Solid hardwood joints on the other hand can be traced across the top, the side and the underside.

SELF STORE

Please refer to price list first to see if any specific self-store rules apply to that table style. If no additional info is listed, you may use this page as a general guide. Please note that custom sizes and changing the top shape can affect self-store capabilities. Tops must be 12" longer than width in order to self-store. In an effort to clear up some confusion that can go with self storing tables, we are providing a general list of table sizes, shape and styles where self storing works or does not work. Always keep in mind when you are selling a table and self storing is requested, there are two major factors in self storing:

- 1) pedestal or trestle base mounting plate size and spacing
- 2) the length of the table slide required to accommodate the amount of leaves needed for the table.

Here is one example of a very common size table that gets ordered self store, but it cannot self store four leaves: 42" x 66" OVAL, 4 leaves. Most people have a tendency to think that the three leaf version can self store all three of the leaves, so it shouldn't be a problem to store four leaves on a four leaf table, however this does not work because for a four leaf table, our slide is 12" longer than on a three leaf table, which forces us to move the slides closer together so they fit between the table skirts. Then there is not enough space between the slides to store more than two leaves.

GENERAL INFORMATION

TRESTLE TABLES WITH RECTANGLE OR BOW END TOPS

- 42" x 60" stores up to 4 leaves, ALL unskirted
- 42" x 66" and 42" x 72" stores up to 4 leaves, 2 with skirts, 2 without
- 48" x 60" stores up to 4 leaves, 2 with skirts, 2 without
- 48" x 66" and 48" x 72" stores up to 4 leaves, ALL unskirted

TRESTLE TABLES WITH BOAT SHAPE TOPS

- 42" x 60" – 1, 2, 3 and 4 leaf tables can only self store 2 leaves BOTH without skirts
- 42" x 66" and 42" x 72" – 1, 2, 3 and 4 leaf tables can only self store 2 leaves, 1 with skirt, 1 without. If a 2, 3, or 4 leaf table is ordered with self store, the last leaf will be unskirted.
- 48" x 60" stores up to 4 leaves, 2 with skirt, 2 without
- 48" x 66" and 48" x 72" stores up to 4 leaves, ALL unskirted

DOUBLE PEDESTAL TABLES WITH RECTANGLE, BOW END, AND SQUARE ROUND TOPS

- Any 42" or 48" wide table can self store up to 4 leaves, 2 with skirt, 2 without.

****NOTE: SQUARE OR ROUND TABLES CANNOT SELF STORE ANY LEAVES!**

DOUBLE PEDESTAL TABLES WITH OVAL AND BANQUET TOPS

- 42" x 54" stores up to 2 leaves, 1 with skirt, 1 without
- 48" x 54" – 48" w leaf does not fit inside of a 54" long oval top
- 42" x 60" – 1, 2 and 3 leaf oval tables store 2 leaves, 1 with skirt, 1 without
- 42" x 60" – 1, 2 and 3 leaf banquet tables store 2 skirted leaves
- 42" x 60" – 4 leaf table cannot store any leaves
- 42" x 66" – 1, 2 and 3 leaf tables store up to 3 leaves, 2 with skirts, 1 without
- 42" x 66" – 4 leaf table can store 2 leaves, 1 with skirt and 1 without.
- 42" x 72" – 1, 2 and 3 leaf tables store up to 3 leaves, 2 with skirts, 1 without
- 42" x 72" – 4 leaf oval table can only store 2 leaves, 1 with skirt, 1 without
- 42" x 72" – 4 leaf banquet table can store up to 4 leaves, 2 with skirts, 2 without
- 48" x 60" – 1, 2, and 3 leaf tables can only store 2 leaves, 1 with skirt, 1 without
- 48" x 60" – 4 leaf table cannot store any leaves
- 48" x 66" – 1, 2, and 3 leaf tables store up to 3 leaves, 2 with skirts, 1 without
- 48" x 66" – 4 leaf table can only store 2 leaves, 1 with skirt, 1 without
- 48" x 72" self stores up to 4 leaves, 2 with skirts, 2 without

SELF STORE

TRESTLE TABLES

42" Leaf (Skirts fit between plates)

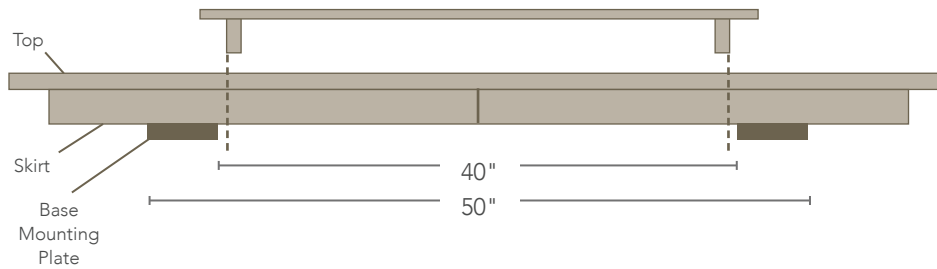

SIDE VIEW OF:

42" x 66" and 42" x 72"
Trestle Table

- Can store up to 4 leaves,
2 with skirt, 2 without

42" Leaf (Skirts come on top of the plates)

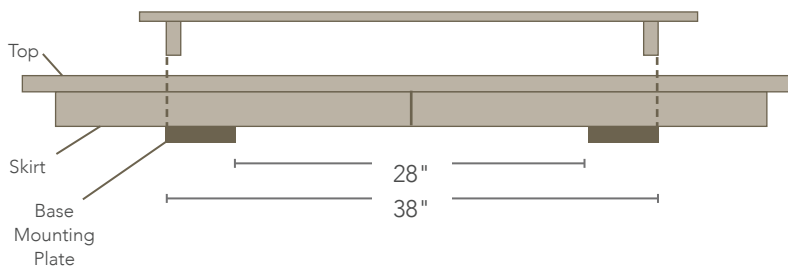

SIDE VIEW OF:

42" x 60" Trestle Table

- Can store up to 4 leaves,
ALL unskirted

48" Leaf (Skirts go on the outside of the plates)

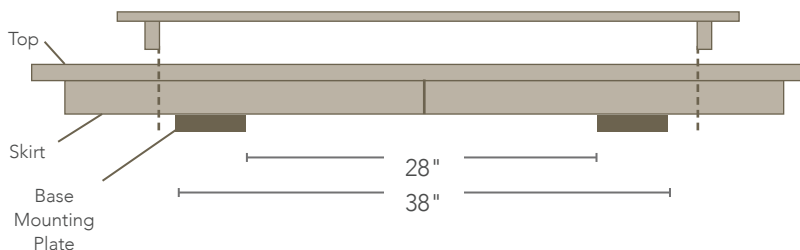

SIDE VIEW OF:

48" x 60" Trestle Table

- Can store up to 4 leaves,
2 with skirt, 2 without

48" Leaf (Skirts come on top of the plates)

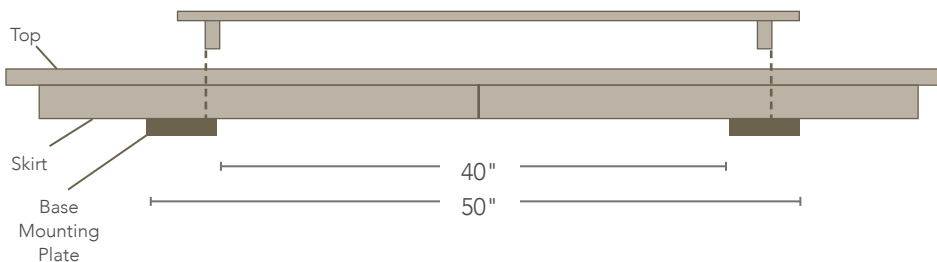

SIDE VIEW OF:

48" x 66" and 48" x 72"
Trestle Table

- Can store up to 4 leaves,
ALL unskirted

SELF STORE

Here are two examples of oval tables that can or cannot self store.

BOTTOM VIEW OF TABLE:

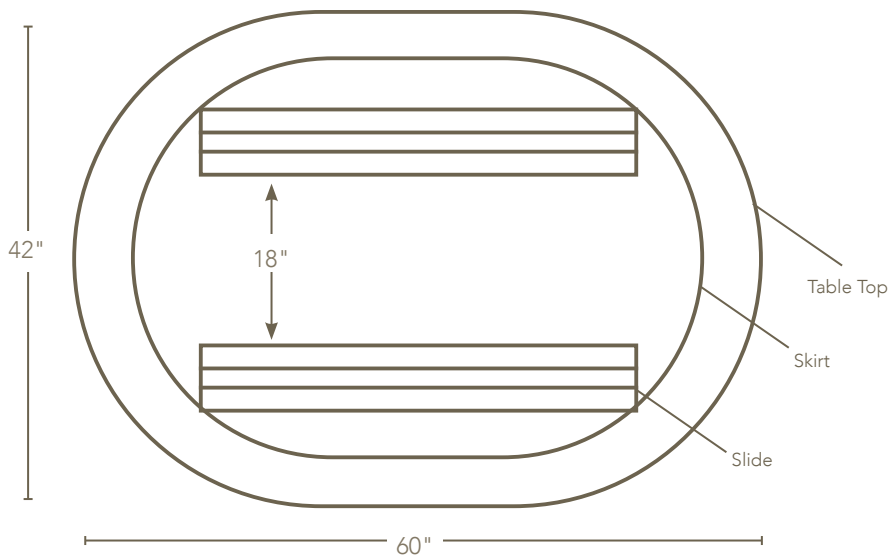

42" x 60" – 3 LEAVES.

Only 1 leaf fits between the slides, so table can only store 2 leaves. 1 leaf on top of the other, 1 with skirt, 1 without.

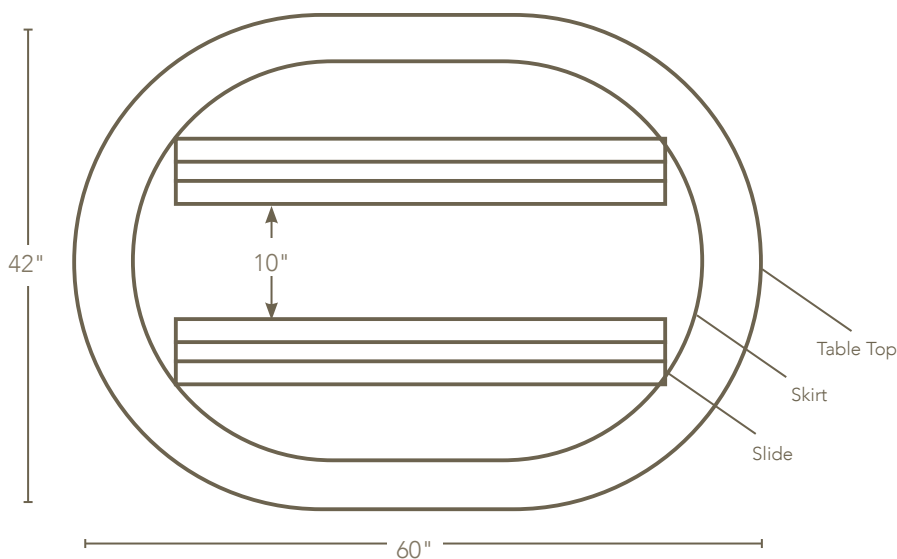

42" x 60" – 4 LEAVES.

Tables slide is 50" long and the table is only 60" long and with the oval shape it pushes the slides in so that there is only 10" max between the slides, therefore this table CANNOT store any of the 4 leaves.

The drawings above hold true for 42" x 66" 3 and 4 leaf tables as far as the length of the slides, however a 42" x 66" 3 leaf double pedestal table has enough space between the slide to store 2 leaves side by side and 1 on top, 2 with skirts, 1 without.

When a 4 leaf slide is used on a 42" x 66" 4 leaf table the slides have to be moved in because of the oval shape which then will only allow 18" between the

slides, therefore this table can only store 2 leaves, 1 with skirt, 1 without. The 2 leaves that cannot store will be skirted.

There are more examples that could be shown here, but we hope our efforts to list the basic "rules" of self storing will help our dealers and their customers to understand why some tables self store leaves and others do not.

LOCKS

Leverlocks: All tables are standard with a leverlock in the center of the table, however ANY table that is ordered with the self store feature will not have a leverlock unless it is special ordered. The lock is removed so that the "catch" part of the lock does not scratch the leaves as they are being put in the self store position.

Leaf Locks: We use a spring lock. These locks are user friendly and adjust well to any movement that will occur naturally with wood products. **Not standard.**

PLEASE NOTE: If self storing and leaf locks are options that your customer is requesting, we highly recommend that they decide which of the 2 options is the most important to them. On certain models of tables, the locks will be right on the plate which takes away space to store 2 leaves on top of each other. As a manufacturer of tables we do not recommend any type of leaf lock, as it is just another piece of hardware that can scratch your beautiful hardwood table.

RUSTIC WOODS

When ordering Rustic Wood tables, please be aware that these tables come standard with filled knots on the table top. We make no guarantees of the size, quantity, or type of knots that a table has. If you want open knots, please specify.



Small Open Knot



Small Knot with Black Epoxy



Large Open Knot



Medium Open Knot



Medium Knot with Black Epoxy



Live Edge Tops will have Filled Knots

ADDISON SINGLE

- 1" Round or Oval top with Mission edge standard
- Base standard as shown (with levelers)
- Available in Oak, Cherry, Quarter Sawn White Oak & Brown Maple
- Floor to bottom of skirt 26½"
- Shown in QSWO with FC-42633 Manchester stain
(Note: Actual color may vary from picture)

AVAILABLE SIZES:

- 30" x 42" Oval
 - 36" x 36" Round
- Up to 2-10" Leaves



EDGE OPTIONS:

MISSION (STANDARD)

5/8" ROUNDOVER

WATERFALL

BEVEL

CHAMFER

TOP SHAPES:

ROUND

OVAL

ADVANCE SINGLE

- 1" Round or Oval top with Mission edge standard
- Base standard as shown (with levelers)
- Available in Oak, Cherry, Quarter Sawn White Oak & Brown Maple
- Floor to bottom of skirt 26½"
- Shown in Oak with FC-9018 Lite Asbury stain
(Note: Actual color may vary from picture)

AVAILABLE SIZES:

- 30" x 42" Oval
 - 36" x 36" Round
- Up to 2-10" Leaves



EDGE OPTIONS:

MISSION (STANDARD)

5/8" ROUNDOVER

WATERFALL

BEVEL

CHAMFER

TOP SHAPES:

ROUND

OVAL

ALANA SINGLE

- 1" Round top with Waterfall edge standard
- Base standard as shown with levelers
- Available in Oak, Cherry, Quarter Sawn White Oak & Brown Maple
- Floor to bottom of skirt 26½"
- Shown in Brown Maple with FC-48024
American Antique stain
(Note: Actual color may vary from picture)

AVAILABLE SIZES:

- 48" x 48" Round
 - 54" x 54" Round
- Up to 2-12" Leaves or
1-18" Butterfly Leaf
- 60" x 60" Round
Round Solid Top Only



EDGE OPTIONS:

MISSION

5/8" ROUNDOVER

WATERFALL
(STANDARD)

BEVEL

CHAMFER

TOP SHAPES:

ROUND

ALBANY

- 1" Round top with Ogee edge standard
- Base standard as shown with levelers
- Available in Oak, Cherry, Quarter Sawn White Oak & Brown Maple
- Floor to bottom of skirt 26½"
- 42" round not recommended due to base size

AVAILABLE SIZES:

- 48" x 48" Round
- 54" x 54" Round
- 60" x 60" Round

Up to 2-12" Leaves or
1-18" Butterfly Leaf
(BF N/A on 60 x 60)



EDGE OPTIONS:

MISSION

5/8" ROUNDOVER

WATERFALL

BEVEL

CHAMFER

OGEE (STANDARD)

TOP SHAPES:

ROUND

ARTS & CRAFTS

- 1" Round top with Bevel edge standard
- Levelers standard
- Available in Oak, Cherry, Quarter Sawn White Oak & Brown Maple

- Floor to bottom of skirt 26½"
- Shown with optional Lazy Susan



AVAILABLE SIZES:

- 48" x 48" Round
- 54" x 54" Round
- 60" x 60" Round
- Up to 2-12" Leaves or 1-18" Butterfly Leaf (BF N/A on 60 x 60)
- 72" x 72" Round
- Round Solid Top Only

EDGE OPTIONS:

- MISSION
- 5/8" ROUNDOVER
- WATERFALL
- BEVEL (STANDARD)
- CHAMFER

TOP SHAPES:

- ROUND



ARTS & CRAFTS CABINET

- 1" Bow End top with Bevel edge standard
- Standard with 1-18" Butterfly leaf
- Available in Oak, Cherry, Quarter Sawn White Oak & Brown Maple
- Cabinet base is 26½" w x 24" d

- 36" high standard. Also available in 30" & 42" h (30" h only has 2 drawers)
- D925-BL Hardware standard
- Floor to bottom of skirt 32½"
- Not available with Round top



AVAILABLE SIZES:

- 42" x 42"
 - 42" x 48"
 - 42" x 54"
 - 48" x 48"
 - 48" x 54"
- With Solid Top, 1-12" Leaf, or 1-18" Butterfly Leaf

EDGE OPTIONS:

- MISSION
- 5/8" ROUNDOVER
- WATERFALL
- BEVEL (STANDARD)
- CHAMFER

TOP SHAPES:

- RECTANGLE
- 1" RADIUS CORNER
- BOW END (STANDARD)



Changing the top shape has an upcharge

ARTS & CRAFTS PUB

- 1" Round top with Bevel edge standard
- Levelers standard
- Available in Oak, Cherry, Quarter Sawn White Oak & Brown Maple
- Floor to bottom of skirt 32½"

AVAILABLE SIZES:

- 48" x 48" Round
 - 54" x 54" Round
 - 60" x 60" Round
- Up to 2-12" Leaves or
1-18" Butterfly Leaf
(BF N/A on 60 x 60)



EDGE OPTIONS:

MISSION

5/8" ROUNDOVER

WATERFALL

BEVEL (STANDARD)

CHAMFER

TOP SHAPES:

ROUND

ARTS & CRAFTS TRESTLE

- 1" Banquet top with Bevel edge standard
- Trestle base - 26" wide
- Available in Oak, Cherry, Quarter Sawn White Oak & Brown Maple
- Floor to bottom of skirt 26½"

AVAILABLE SIZES:

- 42" x 60"
 - 42" x 66"
 - 42" x 72"
 - 48" x 60"
 - 48" x 66"
 - 48" x 72"
- Up to 4-12" Leaves
or 1-18" Butterfly Leaf
or 2-18" Butterfly
Leaves (2 BF N/A on
42 x 60 & 48 x 60)



EDGE OPTIONS:

MISSION

5/8" ROUNDOVER

WATERFALL

BEVEL (STANDARD)

CHAMFER

TOP SHAPES:

RECTANGLE

1" RADIUS CORNER

BOW END

8" SQUARE ROUND

BOAT

BANQUET (STANDARD)

Changing the top shape has an upcharge and may affect self-store ability

ARTS & CRAFTS BENCH

- 1" Rectangle top with Mission edge
- 18" high
- Leaf storage box to store all 4 leaves
- Available in Oak, Cherry, Quarter Sawn White Oak & Brown Maple



AVAILABLE SIZES:

- 12 1/2" x 48"
- 12 1/2" x 60"
- 12 1/2" x 72"

Solid Top or
up to 4-12" Leaves

EDGE OPTIONS:

MISSION
(STANDARD)

TOP SHAPES:

RECTANGLE

BARRINGTON DOUBLE

- 1 1/4" Rectangle top with 1" radius corner & Mission edge
- Base standard as shown (has levelers)
- Available in Oak, Cherry, Brown Maple & Quarter Sawn White Oak
- Floor to bottom of skirt 26 1/2"



AVAILABLE SIZES:

- 42" x 72"
 - 48" x 72"
- Up to 4-12"
Leaves

EDGE OPTIONS:

MISSION
(STANDARD)

5/8" ROUNDOVER

WATERFALL

BEVEL

CHAMFER

TOP SHAPES:

RECTANGLE

1" RADIUS
CORNER
(STANDARD)

BOW END

8" SQUARE
ROUND

BOAT

BANQUET

*Changing the top shape has an upcharge
and may affect self-store ability*

AVERY TRESTLE

- 1¼" Semi-Boat top with Bevel edge standard
- Base standard as shown (has levelers)
- Available in Oak, Cherry, Quarter Sawn White Oak & Brown Maple
- Floor to bottom of skirt 26½"
- Shown in Brown Maple with FC-50240 Carbon top & FC-11047 Ebony base
(Note: Actual color may vary from picture)



EDGE OPTIONS:

MISSION

5/8" ROUNDOVER

WATERFALL

BEVEL
(STANDARD)

CHAMFER

TOP SHAPES:

RECTANGLE

1" RADIUS
CORNER

BOW END

SEMI-BOAT
(STANDARD)

*Changing the top shape has an upcharge
and may affect self-store ability*

AVAILABLE SIZES:

- 42" x 72"
 - 48" x 72"
- Up to 4-12" Leaves



AVERY TRESTLE shown in Brown Maple with FC-50240 Carbon top and FC-11047 Ebony base. Shown with FN Brookfield Chairs.

(Note: Actual color may vary from picture)



BARRINGTON SINGLE

- 1¼" Round top with Mission edge standard
- Base standard as shown (has levelers)
- 42" Round not recommended due to base size
- Available in Oak, Cherry, Brown Maple & Quarter Sawn White Oak
- Floor to bottom of skirt 26½"

AVAILABLE SIZES:

- 48" x 48" Round
 - 54" x 54" Round
 - 60" x 60" Round
- Up to 2-12" Leaves



EDGE OPTIONS:

MISSION (STANDARD)

5/8" ROUNDOVER

WATERFALL

BEVEL

CHAMFER

TOP SHAPES:

ROUND

BASSETT CABINET

- 1" top with 6" clip corner and Mission edge standard
- Standard with 1-18" Butterfly leaf
- Available in Oak, Cherry, Quarter Sawn White Oak & Brown Maple
- Cabinet base is 25½" w x 23½" d (No options on cabinet size)
- 36" high standard. Also available in 30" & 42" h (30" h has no drawer)
- 1586-ORB hardware standard
- Floor to bottom of skirt 32½"
- Not available with Round top

AVAILABLE SIZES:

- 42" x 42"
- 42" x 48"
- 42" x 54"
- 48" x 48"
- 48" x 54"

With Solid Top,
1-12" Leaf, or
1-18" Butterfly Leaf



EDGE OPTIONS:

MISSION (STANDARD)

5/8" ROUNDOVER

WATERFALL

BEVEL

CHAMFER

TOP SHAPES:

RECTANGLE

1" RADIUS CORNER

BOW END

6" CLIPPED CORNERS (STANDARD)

Changing the top shape has an upcharge and may affect self-store ability

BAYTOWN DOUBLE

- 1" Bow End top with Waterfall edge standard
- 2½" straight skirt
- Base standard as shown with levelers
- Available in Oak, Cherry, Quarter Sawn White Oak & Brown Maple
- Floor to bottom of skirt 26½"

EDGE OPTIONS:

- MISSION
- 5/8" ROUNDOVER
- WATERFALL (STANDARD)
- BEVEL
- CHAMFER

TOP SHAPES:

- RECTANGLE
- 1" RADIUS CORNER
- BOW END (STANDARD)
- 8" SQUARE ROUND
- BOAT
- BANQUET

Changing the top shape has an upcharge and may affect self-store ability

AVAILABLE SIZES:

- 42" x 60"
 - 42" x 66"
 - 42" x 72"
 - 48" x 60"
 - 48" x 66"
 - 48" x 72"
- Up to 4-12" Leaves



BAYTOWN DOUBLE shown in Brown Maple with FC-42000 Almond stain. Shown with Artisan Curry Chairs.

(Note: Actual color may vary from picture)



BAYTOWN SINGLE

- 1" Round top with Waterfall edge standard
- Also available in oval top
- Base standard as shown with levelers
- Available in Oak, Cherry, Quarter Sawn White Oak & Brown Maple
- Floor to bottom of skirt 26½"

AVAILABLE SIZES:

- 42" x 42" Round
 - 48" x 48" Round
 - 54" x 54" Round
- Up to 2-12" Leaves,
or 1-18" Butterfly Leaf
(BF N/A on 42 x 42)
- 36" x 48" Oval
 - 42" x 54" Oval
- Up to 2 Leaves
(BF N/A)



EDGE OPTIONS:

MISSION

5/8" ROUNDOVER

WATERFALL
(STANDARD)

BEVEL

CHAMFER

TOP SHAPES:

ROUND

BAYTOWN SINGLE shown in Brown Maple with D22N08963 Sandstone stain. Shown with FN Maverick Chairs.

(Note: Actual color may vary from picture)



BERKSHIRE

- 1¼" thick smooth with 1" corner radius top & Mission edge standard
- 4½" leg standard as shown, optional reeded leg
- 3½" straight skirt
- Available in Oak, Cherry, Quarter Sawn White Oak & Brown Maple
- Floor to bottom of skirt 25½"
- Recommended chair: Berkshire from Artisan Chairs

EDGE OPTIONS:

MISSION
(STANDARD)

5/8" ROUNDOVER

WATERFALL

BEVEL

CHAMFER

TOP SHAPES:

RECTANGLE

1" RADIUS
CORNER
(STANDARD)

BOW END

Changing the top shape
has an upcharge

AVAILABLE SIZES:

- 42" x 60"
- 42" x 66"
- 42" x 72"
- 48" x 60"
- 48" x 66"
- 48" x 72"

Up to 4-12" Leaves



optional
Reeded Leg

BERKSHIRE shown in Brown Maple with Coffee stain. Shown with Artisan Berkshire Reeded Leg Chairs.

(Note: Actual color may vary from picture)



BRADEN TRESTLE

- 1" Rectangle top with 1" radius corners and Waterfall edge standard
- Base standard as shown with levelers
- Available in Oak, Cherry, Quarter Sawn White Oak & Brown Maple
- Floor to bottom of skirt 26½"
- Shown in Brown Maple with FC-42000 Almond top & PCL-183 Muted White 10 sheen base (*Note: Actual color may vary from picture*)



AVAILABLE SIZES:

- 36" x 48"
 - 36" x 54"
 - 36" x 60"
 - 42" x 48"
 - 42" x 54"
 - 42" x 60"
- Up to 3-12" Leaves

EDGE OPTIONS:

- MISSION
- 5/8" ROUND OVER
- WATERFALL (STANDARD)
- BEVEL
- CHAMFER

TOP SHAPES:

- RECTANGLE
- 1" RADIUS CORNER (STANDARD)
- BOW END

Changing the top shape has an upcharge

BRADEN BENCH

- 1" Rectangle top with Mission edge standard
- 18" high
- Leaf storage box to store all 4 leaves
- Available in Oak, Cherry, Quarter Sawn White Oak & Brown Maple
- Shown in Brown Maple with FC-42000 Almond top & PCL-183 Muted White 10 sheen base (*Note: Actual color may vary from picture*)



AVAILABLE SIZES:

- 12 ½" x 48"
 - 12 ½" x 54"
 - 12 ½" x 60"
- Solid Top or up to 3-12" Leaves

EDGE OPTIONS:

- MISSION (STANDARD)

TOP SHAPES:

- RECTANGLE

BRIDGEPORT

- 1" Rectangle top with Reverse Chamfer edge standard
- 3" skirt with Chamfer edge on bottom of skirt
- No gap cover (not available)
- Base standard as shown with levelers
- Available in Oak, Cherry, Quarter Sawn White Oak & Brown Maple
- Floor to bottom of skirt 26"



AVAILABLE SIZES:

- 42" x 60"
 - 42" x 66"
 - 42" x 72"
 - 48" x 60"
 - 48" x 66"
 - 48" x 72"
- Up to 4-12" Leaves

EDGE OPTIONS:

REVERSE CHAMFER
(STANDARD)

TOP SHAPES:

RECTANGLE

BRIDGEPORT BENCH

- 1" Rectangle top with Mission edge standard
- 18" high
- Leaf storage box to store all 4 leaves
- Available in Oak, Cherry, Quarter Sawn White Oak & Brown Maple



AVAILABLE SIZES:

- 12 1/2" x 48"
 - 12 1/2" x 60"
 - 12 1/2" x 72"
- Solid Top or
up to 4-12"
Leaves

EDGE OPTIONS:

MISSION
(STANDARD)

TOP SHAPES:

RECTANGLE

BRIDGEPORT shown in
Brown Maple with
FC-40592 Earthtone stain.
Shown with Artisan
Gatlinburg Chairs.

*(Note: Actual color may
vary from picture)*



BRADY LEG

- 1" Round top with Mission edge standard
- Legs standard as shown (no options)
- Available in Oak, Cherry, Quarter Sawn White Oak & Brown Maple
- Floor to bottom of skirt 26½"
- Not available in pub height



AVAILABLE SIZES:

- 42" x 42" Round
 - 48" x 48" Round
 - 54" x 54" Round
- Up to 2-12" Leaves

EDGE OPTIONS:

- MISSION (STANDARD)
- 5/8" ROUNDOVER
- WATERFALL
- BEVEL
- CHAMFER

TOP SHAPES:

- ROUND

BRINKLEY TRESTLE

- 1" Rectangle top with Bevel edge standard
- Base standard as shown with levelers
- Available in Oak, Cherry, Quarter Sawn White Oak & Brown Maple
- Floor to bottom of skirt 26½"
- Shown in Brown Maple with FC-42000 Almond stain
(Note: Actual color may vary from picture)



AVAILABLE SIZES:

- 42" x 60"
 - 42" x 66"
 - 42" x 72"
 - 48" x 60"
 - 48" x 66"
 - 48" x 72"
- Up to 4-12" Leaves
or 1-18" Butterfly Leaf
or 2-18" Butterfly Leaves
(2 BF N/A on 42x60 or 48x60)

EDGE OPTIONS:

- MISSION
- 5/8" ROUNDOVER
- WATERFALL
- BEVEL (STANDARD)
- CHAMFER

TOP SHAPES:

- RECTANGLE (STANDARD)
- 1" RADIUS CORNER
- BOW END
- 8" SQUARE ROUND
- BOAT
- BANQUET

Changing the top shape has an upcharge and may affect self-store ability

BROADWAY LEG

- 1" Bow End top with Mission edge standard
- 3½" skirt standard as shown
- Curved legs standard as shown
- Available in Oak, Cherry, Quarter Sawn White Oak & Brown Maple
- Floor to bottom of skirt is 25½" at the legs and 26½" at the center
- Shown in Brown Maple with Asbury Brown Stain
(Note: Actual color may vary from picture)

AVAILABLE SIZES:

- 42" x 60"
 - 42" x 66"
 - 42" x 72"
 - 48" x 60"
 - 48" x 66"
 - 48" x 72"
- Up to 4-12" Leaves
or 1-18" Butterfly Leaf



EDGE OPTIONS:

MISSION (STANDARD)

5/8" ROUNDOVER

WATERFALL

BEVEL

CHAMFER

TOP SHAPES:

RECTANGLE

1" RADIUS CORNER

BOW END (STANDARD)

Changing the top shape has an upcharge

BROADWAY BENCH

- 1" Bow End top with Mission edge
- 18" high
- Leaf storage box to store all 4 leaves
- Available in Oak, Cherry, Quarter Sawn White Oak & Brown Maple

AVAILABLE SIZES:

- 12 ½" x 48"
 - 12 ½" x 60"
 - 12 ½" x 72"
- Solid Top or
up to 4-12"
Leaves



EDGE OPTIONS:

MISSION (STANDARD)

TOP SHAPES:

BOW END

BROOKLYN SINGLE

- 1¼" Round top with Mission edge standard
- Black powder coated metal base (with levelers)
- Available in Oak, Cherry, Quarter Sawn White Oak & Brown Maple
- Floor to bottom of skirt 26½"
- Shown in Rustic Walnut with Natural Finish
(Note: Actual color may vary from picture)

AVAILABLE SIZES:

- 42" x 42" Round
 - 48" x 48" Round
 - 54" x 54" Round
- Up to 2-12" Leaves



EDGE OPTIONS:

MISSION (STANDARD)

5/8" ROUNDOVER

WATERFALL

BEVEL

CHAMFER

TOP SHAPES:

ROUND

BROOKVILLE

- 1" Round top with Bevel edge standard
- Base standard as shown with levelers
- Available in Oak, Cherry, Quarter Sawn White Oak & Brown Maple
- Floor to bottom of skirt 26½"
- Recommended chair: Brookville from Artisan Chairs
- Shown in 30" height

AVAILABLE SIZES:

- 48" x 48" Round
 - 54" x 54" Round
 - 60" x 60" Round
- Up to 2-12" Leaves
or 1-18" Butterfly Leaf
(BF N/A on 60 x 60)
- 72" x 72" Round
Round Solid Top Only



EDGE OPTIONS:

MISSION

5/8" ROUNDOVER

WATERFALL

BEVEL (STANDARD)

CHAMFER

TOP SHAPES:

ROUND

BROOKVILLE PUB

- 1" Round top with Bevel edge standard
- Base standard as shown with levelers
- Available in Oak, Cherry, Quarter Sawn White Oak & Brown Maple
- Floor to bottom of skirt 32½"
- Shown in 36" height

AVAILABLE SIZES:

- 48" x 48" Round
 - 54" x 54" Round
 - 60" x 60" Round
- Up to 2-12" Leaves
or 1-18" Butterfly Leaf
(BF N/A on 60 x 60)



EDGE OPTIONS:

MISSION

5/8" ROUND OVER

WATERFALL

BEVEL
(STANDARD)

CHAMFER

TOP SHAPES:

ROUND

BURLINGTON SINGLE

- 1¼" Round top with Waterfall edge standard
- 13" pedestal standard with 48" & 54" top, 15" pedestal standard with 60" & 72" top
- Base standard as shown with levelers
- Available in Oak, Cherry, Quarter Sawn White Oak & Brown Maple
- 42" round not available due to base size
- Floor to bottom of skirt 26½"
- Recommended chair: Ramsey from FN Chairs
- Shown in Brown Maple with Asbury Brown stain
(Note: Actual color may vary from picture)

AVAILABLE SIZES:

- 48" x 48" Round
 - 54" x 54" Round
 - 60" x 60" Round
- Up to 2-12" Leaves
- 72" x 72" Round
Round Solid Top Only



EDGE OPTIONS:

MISSION

5/8" ROUND OVER

WATERFALL
(STANDARD)

BEVEL

CHAMFER

TOP SHAPES:

ROUND

BURLINGTON SINGLE
shown in Brown Maple with
FC-42000 Almond stain.
Shown with Artisan
Bailey Chairs.

*(Note: Actual color may
vary from picture)*



CAMBRIDGE

- 1" Rectangle top with Mission edge standard
- 2½" straight skirt
- Base standard as shown with levelers
- Available in Oak, Cherry, Quarter Sawn White Oak & Brown Maple
- Floor to bottom of skirt 26½"



AVAILABLE SIZES:

- 42" x 60"
- 42" x 66"
- 42" x 72"
- 48" x 60"
- 48" x 66"
- 48" x 72"

Up to 4-12" Leaves
 or 1-18" Butterfly Leaf
 or 2-18" Butterfly Leaves
 (2 BF N/A on 42x60 or 48x60)

EDGE OPTIONS:

- MISSION (STANDARD)
- 5/8" ROUNDOVER
- WATERFALL
- BEVEL
- CHAMFER

TOP SHAPES:

- RECTANGLE (STANDARD)
- 1" RADIUS CORNER
- BOW END
- 8" SQUARE ROUND
- BOAT
- BANQUET

Changing the top shape has an upcharge and may affect self-store ability

CAMBRIDGE BENCH

- 1" Rectangle top with Mission edge
- 18" high
- Leaf storage box to store all 4 leaves
- Available in Oak, Cherry, Quarter Sawn White Oak & Brown Maple



AVAILABLE SIZES:

- 12 ½" x 48"
- 12 ½" x 60"
- 12 ½" x 72"

Solid Top or
 up to 4-12" Leaves

EDGE OPTIONS:

- MISSION (STANDARD)

TOP SHAPES:

- RECTANGLE

CANTERBURY LEG

- 1" Canterbury top with Waterfall edge standard
- 3½" arched skirt
- Legs standard as shown
- Available in Oak, Cherry, Quarter Sawn White Oak & Brown Maple
- Floor to bottom of skirt is 25½" at the legs and 26½" at the center
- Recommended chair: Canterbury from Artisan Chairs

EDGE OPTIONS:

MISSION

5/8" ROUNDOVER

WATERFALL
(STANDARD)

BEVEL

CHAMFER

TOP SHAPES:

RECTANGLE

1" RADIUS
CORNER

CANTERBURY
(STANDARD)

*Changing the top shape
has an upcharge*

AVAILABLE SIZES:

- 42" x 60"
- 42" x 66"
- 42" x 72"
- 48" x 60"
- 48" x 66"
- 48" x 72"

Up to 4-12" Leaves
or 1-18" Butterfly Leaf



CANTERBURY LEG shown in Grey Elm with Michael's Cherry stain and Brown Maple base with Onyx stain. Shown with Artisan Canterbury Chairs.

(Note: Actual color may vary from picture)



CANTERBURY BENCH

- 1" Bow End top with Waterfall edge standard
- 18" high
- Leaf storage box to store all 4 leaves
- Available in Oak, Cherry, Quarter Sawn White Oak & Brown Maple
- Shown in Brown Maple with FC - 9018 Lite Asbury top & FC - 230 Onyx base
(Note: Actual color may vary from picture)



AVAILABLE SIZES:

- 12 1/2" x 48"
- 12 1/2" x 60"
- 12 1/2" x 72"

Solid Top or
up to 4-12" Leaves

EDGE OPTIONS:

WATERFALL
(STANDARD)

TOP SHAPES:

BOW END

CARSON SINGLE

- 1" Round top with Mission edge standard
- Base standard as shown with levelers
- Available in Oak, Cherry, Quarter Sawn White Oak & Brown Maple
- Floor to bottom of skirt 26 1/2"
- Shown in Brown Maple with Med-Dis. FC-14620 Lite Asbury finish



AVAILABLE SIZES:

- 48" x 48" Round
 - 54" x 54" Round
- Up to 2-12" Leaves
or 1-18" Butterfly Leaf

EDGE OPTIONS:

MISSION
(STANDARD)

5/8" ROUNDOVER

WATERFALL

BEVEL

CHAMFER

TOP SHAPES:

ROUND

CHANCELLOR DOUBLE

- 1" Banquet top with Bevel edge standard
- Base standard as shown with levelers
- Available in Oak, Cherry, Quarter Sawn White Oak & Brown Maple
- Floor to bottom of skirt 26½"

EDGE OPTIONS:

MISSION

5/8" ROUNDOVER

WATERFALL

BEVEL
(STANDARD)

CHAMFER

TOP SHAPES:

RECTANGLE

1" RADIUS
CORNER

BOW END

8" SQUARE
ROUND

BANQUET
(STANDARD)

*Changing the top shape has an upcharge
and may affect self-store ability*

AVAILABLE SIZES:

- 42" x 72"
 - 48" x 72"
- Up to 4-12" Leaves



CHANCELLOR DOUBLE shown in
Brown Maple with FC-40592 Earthtone stain.
Shown with Artisan Albany Chairs.

(Note: Actual color may vary from picture)



CHANCELLOR SINGLE

- 1" Round top with Bevel edge standard
- Base standard as shown with levelers
- Available in Oak, Cherry, Quarter Sawn White Oak & Brown Maple
- Floor to bottom of skirt 26½"

AVAILABLE SIZES:

- 42" x 42" Round
 - 48" x 48" Round
 - 54" x 54" Round
- Up to 2-12" Leaves
or 1-18" Butterfly Leaf
(BF N/A on 42x42)



EDGE OPTIONS:

MISSION

5/8" ROUNDOVER

WATERFALL

BEVEL
(STANDARD)

CHAMFER

TOP SHAPES:

ROUND

CHESAPEAKE TRESTLE

- 1" Rectangle top with Mission edge standard
- Base standard as shown (with levelers)
- Available in Oak, Cherry, Quarter Sawn White Oak & Brown Maple
- Floor to bottom of skirt 26½"
- Shown in Brown Maple with FC-40592 Earthtone top & FP-5155 Country White base
(Note: Actual color may vary from picture)



AVAILABLE SIZES:

- 42" x 60"
 - 42" x 66"
 - 42" x 72"
 - 48" x 60"
 - 48" x 66"
 - 48" x 72"
- Up to 4-12" Leaves

EDGE OPTIONS:

MISSION
(STANDARD)

5/8" ROUNDOVER

WATERFALL

BEVEL

CHAMFER

TOP SHAPES:

RECTANGLE
(STANDARD)

1" RADIUS
CORNER

BOW END

8" SQUARE
ROUND

BOAT

BANQUET

Changing the top shape has an upcharge
and may affect self-store ability

CHESAPEAKE BENCH

- 1" Rectangle top with Mission edge standard
- 18" high
- Leaf storage box to store all 4 leaves
- Available in Oak, Cherry, Quarter Sawn White Oak & Brown Maple
- Shown in Brown Maple with FC-40592 Earthtone top & FP-5155 Country White base
(Note: Actual color may vary from picture)



AVAILABLE SIZES:

- 12 1/2" x 48"
- 12 1/2" x 60"
- 12 1/2" x 72"

Solid Top or
up to 4-12" Leaves

EDGE OPTIONS:

MISSION
(STANDARD)

TOP SHAPES:

RECTANGLE

CHEYENNE LEG

- 1 1/4" Rectangle top with Mission edge standard
- Available in Rough Sawn Wormy Maple
- Floor to bottom of skirt 26 1/2"
- Shown in Rough Sawn Wormy Maple with FC-42000 Almond, 10 sheen finish
(Note: Actual color may vary from picture)



AVAILABLE SIZES:

- 36" x 42"
- 36" x 48"
- 36" x 54"
- 42" x 42"
- 42" x 48"
- 42" x 54"

Up to 4-12" Leaves

EDGE OPTIONS:

MISSION
(STANDARD)

TOP SHAPES:

RECTANGLE

CHEYENNE BENCH

- 1¼" Rectangle top with Mission edge standard
- Leaf storage box to store all 4 leaves
- Available in Rough Sawn Wormy Maple
- Shown in Rough Sawn Wormy Maple with FC-24427 Shadow 10 sheen top and FC-47823 Bel Air 10 sheen base
(Note: Actual color may vary from picture)

EDGE OPTIONS:

MISSION
(STANDARD)

TOP SHAPES:

RECTANGLE

AVAILABLE SIZES:

- 12 ½" x 48"
 - 12 ½" x 54"
- Solid Top or
up to 4-12" Leaves



COLEBROOK BENCH

- 1" Rectangle top with Mission edge standard
- 18" high
- Leaf storage box to store all 4 leaves
- Available in Oak, Cherry, Quarter Sawn White Oak & Brown Maple

AVAILABLE SIZES:

- 12 ½" x 48"
 - 12 ½" x 60"
 - 12 ½" x 72"
- Solid Top or
up to 4-12" Leaves



EDGE OPTIONS:

MISSION
(STANDARD)

TOP SHAPES:

RECTANGLE

COLEBROOK TRESTLE

- 1" Boat shape top with Bevel edge standard
- Black inlay in top & base
- Available in Oak, Cherry, Quarter Sawn White Oak & Brown Maple
- Floor to bottom of skirt 26½"
- Recommended chair: Colebrook from RH Yoder

EDGE OPTIONS:

- MISSION
- 5/8" ROUNDOVER
- WATERFALL
- BEVEL (STANDARD)
- CHAMFER

TOP SHAPES:

- RECTANGLE
- 1" RADIUS CORNER
- BOW END
- 8" SQUARE ROUND
- BOAT (STANDARD)
- BANQUET

Changing the top shape has an upcharge and may affect self-store ability

AVAILABLE SIZES:

- 42" x 60"
- 42" x 66"
- 42" x 72"
- 48" x 60"
- 48" x 66"
- 48" x 72"

Up to 4-12" Leaves
or 1-18" Butterfly Leaf
or 2-18" Butterfly Leaves.
(2 BF N/A on 42x60 & 48x60)



COLEBROOK TRESTLE shown in Quarter Sawn White Oak with Michael's Cherry stain. Shown with RH Yoder Colebrook Chairs. (Note: Actual color may vary from picture)

COLUMBUS TRESTLE

- 1¼" Rectangle top with Mission edge standard
- Base standard as shown (with levelers)
- Available in Rough Sawn Wormy Maple
- Authentic "thru-tenon" in base
- Floor to bottom of skirt 26½"
- Shown in Rough Sawn Wormy Maple with FC-42000 Almond 10 sheen finish
(Note: Actual color may vary from picture)

AVAILABLE SIZES:

- 42" x 60"
 - 42" x 72"
 - 48" x 60"
 - 48" x 72"
- Up to 4-12" Leaves



EDGE OPTIONS:

MISSION
(STANDARD)

TOP SHAPES:

RECTANGLE

COLUMBUS TRESTLE shown in Rough Sawn Wormy Maple with FC-42000 Almond 10 sheen finish. Shown with Artisan Columbus Chairs.

(Note: Actual color may vary from picture)



COLUMBUS BENCH

- 1¼" Rectangle top with Mission edge standard
- Leaf storage box to store all 4 leaves
- Available in Rough Sawn Wormy Maple
- Shown in Rough Sawn Wormy Maple with FC-42000 Almond 10 sheen finish
(Note: Actual color may vary from picture)



AVAILABLE SIZES:

- 12 ½" x 48"
- 12 ½" x 60"
- 12 ½" x 72"

Solid Top or
up to 4-12" Leaves

EDGE OPTIONS:

MISSION
(STANDARD)

TOP SHAPES:

RECTANGLE

DALLAS TRESTLE

- 1¼" Rectangle top with Mission edge standard
- Base standard as shown (with levelers)
- Available in Rough Sawn White Oak and Rough Sawn Wormy Maple
- Floor to bottom of skirt 26½"
- Shown in Rough Sawn White Oak with PCL-173 Desert DusK, 10 sheen finish
(Note: Actual color may vary from picture)



AVAILABLE SIZES:

- 36" x 48"
- 36" x 54"
- 36" x 60"
- 42" x 48"
- 42" x 54"
- 42" x 60"

Up to 3-12" Leaves

EDGE OPTIONS:

MISSION
(STANDARD)

TOP SHAPES:

RECTANGLE



DAYTON LEG

- 1" smooth Rectangle top with grain lengthwise and Mission edge standard
- 2 1/2" x 2 1/2" x 29" taper shaker legs standard
- Available in Oak, Cherry, Quarter Sawn White Oak & Brown Maple
- Floor to bottom of skirt 26 1/2"

AVAILABLE SIZES:

- 42" x 30"
- 42" x 33"
- 42" x 36"
- 48" x 30"
- 48" x 33"
- 48" x 36"

Solid Top Only



EDGE OPTIONS:

MISSION (STANDARD)

5/8" ROUNDOVER

WATERFALL

BEVEL

CHAMFER

TOP SHAPES:

RECTANGLE (STANDARD)

1" RADIUS CORNER

Changing the top shape has an upcharge

DENVER BENCH

- 1" Rectangle top with Mission edge
- 18" high
- Leaf storage box to store all 4 leaves
- Available in Oak, Cherry, Quarter Sawn White Oak & Brown Maple

AVAILABLE SIZES:

- 12 1/2" x 48"
- 12 1/2" x 60"
- 12 1/2" x 72"

Solid Top or up to 4-12" Leaves



EDGE OPTIONS:

MISSION (STANDARD)

TOP SHAPES:

RECTANGLE

DENVER LEG

- 1" Rectangle top with Bevel edge standard
- 2½" straight skirt standard
- Non-geared wooden slides
- Available in Oak, Cherry, Quarter Sawn White Oak & Brown Maple
- Floor to bottom of skirt 26½"

AVAILABLE SIZES:

- 42" x 60"
- 42" x 66"
- 42" x 72"
- 48" x 60"
- 48" x 66"
- 48" x 72"

Up to 4-12" Leaves
or 1-18" Butterfly Leaf



EDGE OPTIONS:

MISSION

5/8" ROUNDOVER

WATERFALL

BEVEL
(STANDARD)

CHAMFER

TOP SHAPES:

RECTANGLE
(STANDARD)

1" RADIUS
CORNER

BOW END

BOAT

Changing the top shape has an upcharge and may affect self-store ability

DENVER LEG shown in Brown Maple with FC-40592 Earthtone stain. Shown with FN Ramsey Chairs.

(Note: Actual color may vary from picture)



DOVER LEG

- 1" Rectangle top with Mission edge standard
- 2½" straight skirt
- 2½" x 2½" x 29" taper shaker legs standard
- Available in Oak, Cherry, Quarter Sawn White Oak & Brown Maple
- Floor to bottom of skirt 26½"

AVAILABLE SIZES:

- 36" x 42"
- 36" x 48"
- 36" x 54"
- 42" x 42"
- 42" x 48"
- 42" x 54"

Up to 4-12" Leaves



EDGE OPTIONS:

MISSION (STANDARD)

5/8" ROUNDOVER

WATERFALL

BEVEL

CHAMFER

TOP SHAPES:

RECTANGLE (STANDARD)

1" RADIUS CORNER

BOW END

Changing the top shape has an upcharge



DOVER LEG shown in Red Oak with FC-47865 Grey Flannel stain. Shown with FN Lodge Chairs.

(Note: Actual color may vary from picture)

DUTCH DOUBLE

- 1" top with 8" Square Round with Roundover edge standard
- Base standard as shown with levelers
- Only self-stores unskirted leaves

- Available in Oak, Cherry Quarter Sawn White Oak & Brown Maple
- Floor to bottom of skirt 26½"



EDGE OPTIONS:

- MISSION
- 5/8" ROUNDOVER (STANDARD)
- WATERFALL
- BEVEL
- CHAMFER

TOP SHAPES:

- RECTANGLE
- 1" RADIUS CORNER
- BOW END
- 8" SQUARE ROUND (STANDARD)

Changing the top shape has an upcharge and may affect self-store ability

AVAILABLE SIZES:

- 42" x 60"
- 42" x 66"
- 42" x 72"
- 48" x 60"
- 48" x 66"
- 48" x 72"

Up to 4-12" Leaves
(N/A on 42x60 Oval)

EASTON SINGLE

- 1" Round top with Waterfall edge
- Base standard as shown with levelers
- Available in Oak, Cherry, Brown Maple & Quarter Sawn White Oak
- Floor to bottom of skirt 26½"



EDGE OPTIONS:

- MISSION
- 5/8" ROUNDOVER
- WATERFALL (STANDARD)
- BEVEL
- CHAMFER

TOP SHAPES:

- ROUND

AVAILABLE SIZES:

- 42" x 42" Round
- 48" x 48" Round

Up to 2-12" Leaves
or 1-18" Butterfly Leaf
(BF N/A on 42x42)

EL DORADO TRESTLE

- 1¾" Rectangle top with Live Edge standard
- Available in Rough Sawn Wormy Maple
- Black powder coated metal base
- Base standard as shown (with levelers)
- Every live edge is unique and will vary from top to top
- Shown in Rough Sawn Wormy Maple with FC-47823 Bel Air, 10 sheen finish
(Note: Actual color may vary from picture)

EDGE OPTIONS:

LIVE/MISSION
(STANDARD)

TOP SHAPES:

RECTANGLE

AVAILABLE SIZES:

- 42" x 72"
- 42" x 84"
- 42" x 96"
- 48" x 72"
- 48" x 84"
- 48" x 96"

Solid Top Only



EL DORADO TRESTLE shown in Rough Sawn Wormy Maple with FC-47823 Bel Air 10 sheen finish. Shown with West Point El Dorado Bench and FN Denver Chairs.

(Note: Actual color may vary from picture)



EL DORADO BENCH

- 1¾" Rectangle top with Live Edge standard
- Available in Rough Sawn Wormy Maple
- Shown in Rough Sawn Wormy Maple with FC-47823 Bel Air, 10 sheen finish
(Note: Actual color may vary from picture)



AVAILABLE SIZES:

- 12 ½" x 72"
 - 12 ½" x 84"
 - 12 ½" x 96"
- Solid Top Only

EDGE OPTIONS:

LIVE/MISSION
(STANDARD)

TOP SHAPES:

RECTANGLE

EL PASO BENCH

- 1¾" Rectangle top with Mission standard
- Available in Rough Sawn Wormy Maple
- Shown in Rough Sawn Wormy Maple with FC-42000 Almond, 10 sheen finish
(Note: Actual color may vary from picture)



AVAILABLE SIZES:

- 12 ½" x 68"
 - 12 ½" x 80"
- Solid Top or
up to 3-16" Leaves

EDGE OPTIONS:

MISSION
(STANDARD)

TOP SHAPES:

RECTANGLE

EL PASO TRESTLE

- 1¾" Rectangle top with Mission edge standard
- Available in Rough Sawn Wormy Maple
- Authentic "thru-tenon" in base
- Recommended chair: Houston from FN Chairs
- Floor to bottom of skirt 26½"

- Shown in Rough Sawn Wormy Maple with FC-42000 Almond 10 sheen
- The 68" table will only fit one chair per side
(Note: Actual color may vary from picture)

AVAILABLE SIZES:

- 42" x 68"
 - 42" x 80"
 - 48" x 68"
 - 48" x 80"
- Up to 3-16" Leaves



EDGE OPTIONS:

MISSION
(STANDARD)

TOP SHAPES:

RECTANGLE



EL PASO TRESTLE shown in Rough Sawn Wormy Maple with FC-42000 Almond 10 sheen finish. Shown with FN Chairs Houston Chairs.

(Note: Actual color may vary from picture)



ELLIANNA LEG

- 1" Rectangle top with 2" Radius corners and Mission edge is standard
- Legs standard as shown
- Available in Oak, Cherry, Quarter Sawn White Oak & Brown Maple
- Floor to bottom of skirt 26"
- Shown in Plain Sawn White Oak with Natural 10 sheen finish
(Note: Actual color may vary from picture)

AVAILABLE SIZES:

- 42" x 60"
 - 42" x 66"
 - 42" x 72"
 - 48" x 60"
 - 48" x 66"
 - 48" x 72"
- Up to 4-12" Leaves



EDGE OPTIONS:

- MISSION (STANDARD)
- 5/8" ROUNDOVER
- WATERFALL
- BEVEL
- CHAMFER

TOP SHAPES:

- 2" RADIUS CORNER

ETHAN

- 1" Rectangle top with Mission edge standard
- 4½" straight skirt with molding, standard as shown
- 3" x 3" tapered leg with molding, standard as shown
- Available in Oak, Cherry, Quarter Sawn White Oak & Brown Maple
- Floor to bottom of skirt 24½"
- 3½" skirts recommended for arm chairs (Floor to bottom of skirt is 25½")
- Not available with boat shape top
- Shown in Brown Maple with FC-42633 Manchester finish
(Note: Actual color may vary from picture)

AVAILABLE SIZES:

- 42" x 60"
 - 42" x 66"
 - 42" x 72"
 - 48" x 60"
 - 48" x 66"
 - 48" x 72"
- Up to 4-12" Leaves



EDGE OPTIONS:

- MISSION (STANDARD)
- 5/8" ROUNDOVER
- WATERFALL
- BEVEL
- CHAMFER

TOP SHAPES:

- RECTANGLE (STANDARD)

- 1" RADIUS CORNER

- BOW END

Changing the top shape has an upcharge

FENWAY TRESTLE PUB

- 1¼" Rectangle top with Mission edge and grain lengthwise standard
- Base standard as shown with levelers
- 36" high is standard. Not available in 30" or 42" high.
- Black powder coated metal footrail (no color options)
- Available in Oak, Cherry, Quarter Sawn White Oak & Brown Maple
- Shown in Plain Sawn White Oak top with FC-107 Harvest 10 sheen & Brown Maple base with PCL-183 Muted White 10 sheen *(Note: Actual color may vary from picture)*

AVAILABLE SIZES:

- 36" x 48"
 - 36" x 54"
 - 36" x 60"
 - 36" x 72"
- Solid Top Only



EDGE OPTIONS:

- MISSION (STANDARD)
- 5/8" ROUNDOVER
- WATERFALL
- BEVEL
- CHAMFER

TOP SHAPES:

- RECTANGLE (STANDARD)
- 1" RADIUS CORNER

Changing the top shape has an upcharge

FREMONT TRESTLE

- 1" top with 1" corner radius and Bevel edge standard
- Base standard as shown with levelers
- Available in Oak, Cherry, Quarter Sawn White Oak & Brown Maple
- Recommended chair: Fremont from Artisan Chairs
- Floor to bottom of skirt 26½"

AVAILABLE SIZES:

- 42" x 60"
 - 42" x 66"
 - 42" x 72"
 - 48" x 60"
 - 48" x 66"
 - 48" x 72"
- Up to 4-12" Leaves
or 1-18" Butterfly Leaf
or 2-18" Butterfly Leaves
(2 BF N/A on 42x60 or 48x60)



EDGE OPTIONS:

- MISSION
- 5/8" ROUNDOVER
- WATERFALL
- BEVEL (STANDARD)
- CHAMFER

TOP SHAPES:

- RECTANGLE
- 1" RADIUS CORNER (STANDARD)
- BOW END
- 8" SQUARE ROUND
- BOAT
- BANQUET

Changing the top shape has an upcharge and may affect self-store ability

FULTON TRESTLE

- 1" Rectangle top with Mission edge standard
- Base standard as shown with levelers
- Available in Oak, Cherry, Quarter Sawn White Oak & Brown Maple
- Floor to bottom of skirt 26½"
- Shown in Brown Maple with FC-50240 Carbon top & RNC-1003 Icicle base
(Note: Actual color may vary from picture)



EDGE OPTIONS:

MISSION
(STANDARD)

5/8" ROUNDOVER

WATERFALL

BEVEL

CHAMFER

TOP SHAPES:

RECTANGLE
(STANDARD)

1" RADIUS
CORNER

BOW END

Changing the top shape
has an upcharge

AVAILABLE SIZES:

- 36" x 48"
- 36" x 54"
- 36" x 60"
- 42" x 48"
- 42" x 54"
- 42" x 60"

Up to 3-12" Leaves

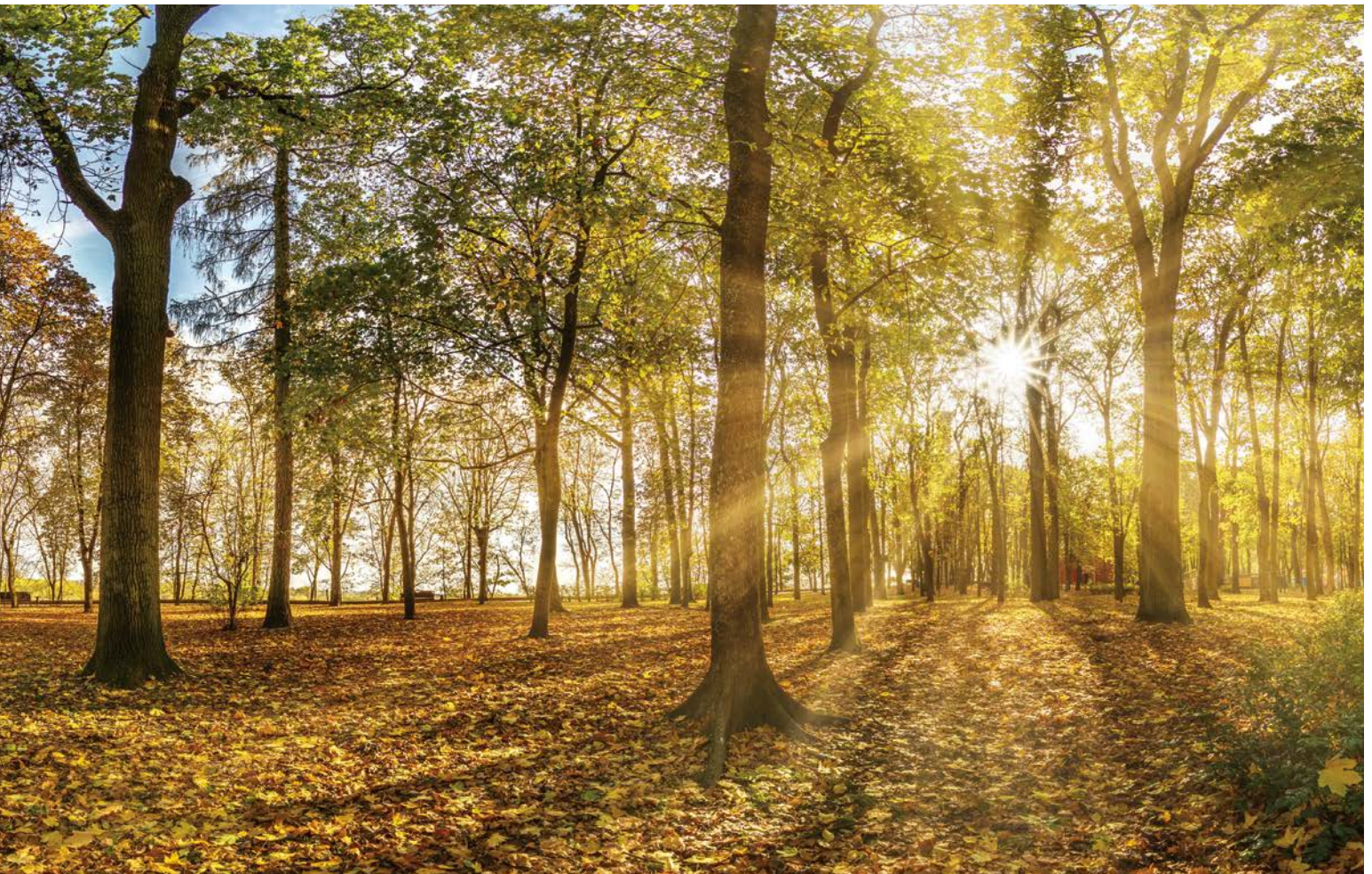

GALENA TRESTLE

- 1" Bow End top with Waterfall edge standard
- Base standard as shown with levelers
- Available in Oak, Cherry, Quarter Sawn White Oak & Brown Maple
- Floor to bottom of skirt 26½"



AVAILABLE SIZES:

- 42" x 60"
- 42" x 66"
- 42" x 72"
- 48" x 60"
- 48" x 66"
- 48" x 72"

Up to 4-12" Leaves
or 1-18" Butterfly Leaf
or 2-18" Butterfly Leaves
(2 BF N/A on 42x60 & 48x60)

EDGE OPTIONS:

MISSION

5/8" ROUNDOVER

WATERFALL
(STANDARD)

BEVEL

CHAMFER

TOP SHAPES:

RECTANGLE

1" RADIUS
CORNER

BOW END
(STANDARD)

8" SQUARE
ROUND

BOAT

BANQUET

*Changing the top shape has an upcharge
and may affect self-store ability*



GALENA TRESTLE shown in Quarter Sawn White Oak with FC-7992 Asbury Brown stain. Shown with Artisan Galena Chairs.

(Note: Actual color may vary from picture)

GALENA BENCH

- 1" Rectangle top with Mission edge standard
- Available in Oak, Cherry, Quarter Sawn White Oak & Brown Maple
- Shown in Quarter Sawn White Oak with Asbury Brown stain
(Note: Actual color may vary from picture)



AVAILABLE SIZES:

- 12 ½" x 48"
- 12 ½" x 60"
- 12 ½" x 72"

Solid Top or
up to 4-12" Leaves



EDGE OPTIONS:

MISSION
(STANDARD)

TOP SHAPES:

RECTANGLE

HAMPTON

- 1" Rectangle top with Bullnose edge standard
- 3½" rounded skirt as shown
- No gap covers
- Available in Oak, Cherry, Quarter Sawn White Oak & Brown Maple
- Floor to bottom of skirt 25½"



AVAILABLE SIZES:

- 42" x 60"
- 42" x 66"
- 42" x 72"
- 48" x 60"
- 48" x 66"
- 48" x 72"

Up to 4-12" Leaves

EDGE OPTIONS:

BULLNOSE
(STANDARD)

TOP SHAPES:

RECTANGLE

HAMPTON BENCH

- 1" Rectangle top with Mission edge
- 18" high
- Leaf storage box to store all 4 leaves
- Available in Oak, Cherry, Quarter Sawn White Oak & Brown Maple



AVAILABLE SIZES:

- 12 1/2" x 48"
- 12 1/2" x 60"
- 12 1/2" x 72"

Solid Top or
up to 4-12" Leaves

EDGE OPTIONS:

MISSION
(STANDARD)

TOP SHAPES:

RECTANGLE

HAMPTON LEG

- 1" Rectangle top with Bullnose edge
- 3 1/2" rounded skirt standard as shown
- No gap covers
- Leg standard as shown, optional reeded leg
- Available in Oak, Cherry, Quarter Sawn White Oak & Brown Maple
- Floor to bottom of skirt 25 1/2"



AVAILABLE SIZES:

- 42" x 60"
- 42" x 66"
- 42" x 72"
- 48" x 60"
- 48" x 66"
- 48" x 72"

Up to 4-12" Leaves

EDGE OPTIONS:

BULLNOSE
(STANDARD)

TOP SHAPES:

RECTANGLE

HARRISON DOUBLE

- Oval top with Bevel edge standard
- Feet standard as shown with levelers
- Plain bar spreader
- Available in Oak, Cherry, Quarter Sawn White Oak & Brown Maple
- Recommended chair: Meridan from FN Chairs
- Floor to bottom of skirt 26½"



EDGE OPTIONS:

MISSION

5/8" ROUNDOVER

WATERFALL

BEVEL
(STANDARD)

CHAMFER

AVAILABLE SIZES:

- 42" x 60"
- 42" x 66"
- 42" x 72"
- 48" x 60"
- 48" x 66"
- 48" x 72"

Up to 4-12" Leaves

TOP SHAPES:

RECTANGLE

1" RADIUS
CORNER

BOW END

OVAL
(STANDARD)

BOAT

BANQUET

Changing the top shape has an upcharge and may affect self-store ability

HARRISON SINGLE

- 1" Round top with Bevel edge standard
- Base standard as shown with levelers
- Available in Oak, Cherry, Quarter Sawn White Oak & Brown Maple
- Floor to bottom of skirt 26½"



EDGE OPTIONS:

MISSION

5/8" ROUNDOVER

WATERFALL

BEVEL
(STANDARD)

CHAMFER

TOP SHAPES:

ROUND

AVAILABLE SIZES:

- 42" x 42" Round
- 48" x 48" Round
- 54" x 54" Round

Up to 2-12" Leaves
or 1-18" Butterfly Leaf
(BF N/A on 42x42)

HARTFORD TRESTLE

- 1" Bow End top with Mission edge standard
- Trestle base standard as shown (no options)
- All leaves will be skirted unless ordered without
- Available in Oak, Cherry, Quarter Sawn White Oak & Brown Maple
- Note: starting size cannot be less than 78" due to the space needed for the base
- Floor to bottom of skirt 26½"
- See expanded view below

AVAILABLE SIZES:

- 42" x 78"
- 48" x 78"

From 10-12" to 14-12" Leaves



EDGE OPTIONS:

- MISSION (STANDARD)
- 5/8" ROUNDOVER
- WATERFALL
- BEVEL
- CHAMFER

TOP SHAPES:

- RECTANGLE
- 1" RADIUS CORNER
- BOW END (STANDARD)

Changing the top shape has an upcharge



HARVEST LEG

- 1¼" Rectangle top with Mission edge standard
- 4½" Harvest legs are standard, no other leg options
- 4½" skirt standard; floor to bottom of skirt 24½"
- Standard table not made for arm chairs, if arm chairs are used you must specify on order, then arm chair skirt will be used on the ends (Arm chair skirts N/A on 42" wide table)
- Available in Oak, Cherry, Quarter Sawn White Oak & Brown Maple
- Shown in Brown Maple with Asbury Brown Burnished
(Note: Actual color may vary from picture)



EDGE OPTIONS:

MISSION (STANDARD)

5/8" ROUNDOVER

WATERFALL

BEVEL

CHAMFER

TOP SHAPES:

RECTANGLE (STANDARD)

1" RADIUS CORNER

BOW END

Changing the top shape has an upcharge

AVAILABLE SIZES:

- 42" x 60"
 - 42" x 66"
 - 42" x 72"
 - 48" x 60"
 - 48" x 66"
 - 48" x 72"
- Up to 4-12" Leaves



Skirt to allow for arm chairs.
Arm chair cutout not available on 42" w tables.

HARVEST BENCH

- 1" Rectangle top with Mission edge
- 18" high
- Leaf storage box to store all 4 leaves
- Available in Oak, Cherry, Quarter Sawn White Oak & Brown Maple
- Shown in Brown Maple with Asbury Brown Burnished
(Note: Actual color may vary from picture)



AVAILABLE SIZES:

- 12 ½" x 48"
 - 12 ½" x 60"
 - 12 ½" x 72"
- Solid Top or up to 4-12" Leaves

EDGE OPTIONS:

MISSION (STANDARD)

TOP SHAPES:

RECTANGLE

HEIDI CABINET

- 1" top with 1" radius corners & Mission edge standard
- Standard with 1-18" Butterfly leaf
- Standard with basket drawers featuring soft-close slides as shown
- Available in Oak, Cherry, Quarter Sawn White Oak & Brown Maple
- Floor to bottom of skirt 32½"
- Not available with Round top

- Cabinet base is 26" w x 26" d (No options on cabinet size)
- 36" high standard. Also available in 30" h
- Shown with dark drawer baskets (standard)
- Shown in Brown Maple with SP-151 Weathered Black Med-Dis. 10 sheen top and SP-154 Washed Gray Med-Dis. 10 sheen base
(Note: Actual color may vary from picture)



AVAILABLE SIZES:

- 42" x 42"
- 42" x 48"
- 42" x 54"
- 48" x 48"
- 48" x 54"

With Solid Top,
1-12" Leaf, or
1-18" Butterfly Leaf



Dark

Medium

Light

EDGE OPTIONS:

- MISSION (STANDARD)
- 5/8" ROUND OVER
- WATERFALL
- BEVEL
- CHAMFER

TOP SHAPES:

- RECTANGLE
- 1" RADIUS CORNER (STANDARD)
- BOW END

Changing the top shape has an upcharge



HEIDI CABINET shown in Brown Maple SP-151 Weathered Black Med. Distressed 10 sheen and SP-154 Washed Gray Med. Distressed 10 sheen base stain. Shown with Denver Chairs from Artisan Chairs.
(Note: Actual color may vary from picture)

HEIDI LEG

- 1" Rectangle top with Mission edge standard
- Arched skirt standard as shown
- 3" x 3" straight legs standard
- Available in Oak, Cherry, Quarter Sawn White Oak & Brown Maple
- Floor to bottom of skirt is 24½" at the legs and 26½" at the center
- Available in 36" & 42" high

EDGE OPTIONS:

MISSION
(STANDARD)

5/8" ROUNDOVER

WATERFALL

BEVEL

CHAMFER

TOP SHAPES:

RECTANGLE
(STANDARD)

1" RADIUS
CORNER

BOW END

Changing the top shape
has an upcharge

AVAILABLE SIZES:

- 42" x 60"
- 42" x 66"
- 42" x 72"
- 48" x 60"
- 48" x 66"
- 48" x 72"

Up to 4-12" Leaves
or 1-18" Butterfly Leaf



HEIDI LEG shown in Brown Maple with
FC-42000 Almond top & PCL-175 Mineral base.
Shown with Artisan Garrison Chairs.

(Note: Actual color may vary from picture)



HEIDI BENCH

- 1" Rectangle top with Mission edge
- 18" high
- Leaf storage box to store all 4 leaves
- Available in Oak, Cherry, Quarter Sawn White Oak & Brown Maple



AVAILABLE SIZES:

- 12 1/2" x 48"
- 12 1/2" x 60"
- 12 1/2" x 72"

Solid Top or
up to 4-12" Leaves

EDGE OPTIONS:

MISSION
(STANDARD)

TOP SHAPES:

RECTANGLE

IMPERIAL SINGLE

- 1" Round top with Bevel edge
- Base standard as shown
- Available in Oak, Cherry, Quarter Sawn White Oak & Brown Maple
- Floor to bottom of skirt 26 1/2"



AVAILABLE SIZES:

- 42" x 42" Round
 - 48" x 48" Round
 - 54" x 54" Round
- Up to 2-12" Leaves
or 1-18" Butterfly Leaf
(BF N/A on 42x42)

EDGE OPTIONS:

MISSION

5/8" ROUNDOVER

WATERFALL

BEVEL
(STANDARD)

CHAMFER

TOP SHAPES:

ROUND

IMPERIAL DOUBLE

- 1" Oval top with Bevel edge standard
- Base standard as shown
- Available in Oak, Cherry, Quarter Sawn White Oak & Brown Maple
- Floor to bottom of skirt 26½"



EDGE OPTIONS:

- MISSION
- 5/8" ROUNDOVER
- WATERFALL
- BEVEL (STANDARD)
- CHAMFER

TOP SHAPES:

- RECTANGLE
- 1" RADIUS CORNER
- BOW END
- OVAL (STANDARD)
- BOAT
- BANQUET

Changing the top shape has an upcharge and may affect self-store ability

AVAILABLE SIZES:

- 42" x 60"
 - 42" x 66"
 - 42" x 72"
 - 48" x 60"
 - 48" x 66"
 - 48" x 72"
- Up to 4-12" Leaves

IMPERIAL SINGLE PUB

- 1" Round top with Bevel Edge standard
- Base standard as shown with levelers
- Available in Oak, Cherry, Quarter Sawn White Oak & Brown Maple
- Floor to bottom of skirt 32½"
- Pub height standard 36" high (not available in 42" high)



EDGE OPTIONS:

- MISSION
- 5/8" ROUNDOVER
- WATERFALL
- BEVEL (STANDARD)
- CHAMFER

TOP SHAPES:

- ROUND

AVAILABLE SIZES:

- 42" x 42" Round
 - 48" x 48" Round
- Up to 2-12" Leaves
or 1-18" Butterfly Leaf
(BF N/A on 42x42)
- 54" x 54" Round
Solid Top Only



IMPERIAL DOUBLE shown
in Brown Maple with
FC-40592 Earthtone stain.
Shown with Artisan
Baytown Chairs.

*(Note: Actual color may
vary from picture)*

JAMESTOWN

- 1" Rectangle top with Mission edge standard
- Base standard as shown with levelers
- Available in Oak, Cherry, Quarter Sawn White Oak & Brown Maple

- Floor to bottom of skirt 26½"
- Recommended chair: Jamestown from Artisan Chairs

EDGE OPTIONS:

- MISSION (STANDARD)
- 5/8" ROUNDOVER
- WATERFALL
- BEVEL
- CHAMFER

TOP SHAPES:

- RECTANGLE (STANDARD)
- 1" RADIUS CORNER
- BOW END
- 8" SQUARE ROUND
- BOAT
- BANQUET

Changing the top shape has an upcharge and may affect self-store ability



AVAILABLE SIZES:

- 42" x 60"
- 42" x 66"
- 42" x 72"
- 48" x 60"
- 48" x 66"
- 48" x 72"

Up to 4-12" Leaves
or 1-18" Butterfly Leaf
or 2-18" Butterfly Leaves
(2 BF N/A on 42x60 & 48x60)

KINGSBURY MISSION TRESTLE

- 1" Rectangle top with Mission edge standard
- Trestle base is 24" wide
- Available in Oak, Cherry, Quarter Sawn White Oak & Brown Maple
- Floor to bottom of skirt 26½"

EDGE OPTIONS:

- MISSION (STANDARD)
- 5/8" ROUNDOVER
- WATERFALL
- BEVEL
- CHAMFER

TOP SHAPES:

- RECTANGLE (STANDARD)
- 1" RADIUS CORNER
- BOW END
- 8" SQUARE ROUND
- BOAT
- BANQUET

Changing the top shape has an upcharge and may affect self-store ability



AVAILABLE SIZES:

- 42" x 60"
- 42" x 66"
- 42" x 72"
- 48" x 60"
- 48" x 66"
- 48" x 72"

Up to 4-12" Leaves
or 1-18" Butterfly Leaf
or 2-18" Butterfly Leaves
(2 BF N/A on 42x60 & 48x60)

KINGSLEY SINGLE

- 1¼" Round top with Roundover edge standard
- Base standard as shown with levelers
- Available in Oak, Cherry, Quarter Sawn White Oak & Brown Maple
- Floor to bottom of skirt 26½"
- Recommended chair: Kimberley from FN Chairs

AVAILABLE SIZES:

- 48" x 48" Round
- 54" x 54" Round
- 60" x 60" Round
- Up to 2-12" Leaves



EDGE OPTIONS:

MISSION

5/8" ROUND-OVER (STANDARD)

WATERFALL

BEVEL

CHAMFER

TOP SHAPES:

ROUND

KINGSLEY SINGLE shown in Brown Maple with Rich Tobacco stain. Shown with FN Chairs Kimberley Chairs with 28-21 Cinnemax Fabric seat.

(Note: Actual color may vary from picture)



KNOXVILLE

- 1" Rectangle top with Chamfer edge
- Base standard as shown with levelers
- Available in Oak, Cherry, Quarter Sawn White Oak & Brown Maple
- Floor to bottom of skirt 26½"



EDGE OPTIONS:

MISSION

5/8" ROUNDOVER

WATERFALL

BEVEL

CHAMFER
(STANDARD)

TOP SHAPES:

RECTANGLE
(STANDARD)

1" RADIUS
CORNER

BOW END

Changing the top shape has an upcharge

AVAILABLE SIZES:

- 42" x 72"
 - 48" x 72"
- Up to 4-12" Leaves



LAMESA TRESTLE

- 1½" Rectangle top with Live edge on ends standard
- Ball bearing slides are standard
- Base standard as shown with levelers
- Available in Wormy Maple, Rustic Cherry & Rustic Walnut
- Every Live edge top is unique and will vary from top to top
- Floor to bottom of skirt 26½"
- Shown in Rustic Walnut with Natural finish (Note: Actual color may vary from picture)



EDGE OPTIONS:

LIVE/MISSION
(STANDARD)

TOP SHAPES:

RECTANGLE

AVAILABLE SIZES:

- 42" x 72"
 - 48" x 72"
- Up to 4-12" Leaves



LAPORTE BENCH

- 1½" Rectangle top with Live Edge standard
- Available in Wormy Maple, Rustic Cherry & Rustic Walnut
- Every Live edge top is unique and will vary from top to top
- Shown in Rustic Walnut with Natural finish (*Note: Actual color may vary from picture*)



AVAILABLE SIZES:

- 12 ½" x 72"
- 12 ½" x 84"

Solid Top Only

EDGE OPTIONS:

LIVE/MISSION
(STANDARD)

TOP SHAPES:

RECTANGLE

LAPORTE TRESTLE

- 1½" Rectangle top with Live edge standard
- Base standard as shown (with levelers)
- Available in Wormy Maple, Rustic Cherry & Rustic Walnut
- Every Live edge top is unique and will vary from top to top
- Shown in Rustic Walnut with Natural finish (*Note: Actual color may vary from picture*)



AVAILABLE SIZES:

- 42" x 72"
- 42" x 84"
- 42" x 96"
- 48" x 72"
- 48" x 84"
- 48" x 96"

Solid Top Only

EDGE OPTIONS:

LIVE/MISSION
(STANDARD)

TOP SHAPES:

RECTANGLE

LAREDO TRESTLE

- 1¾" Rectangle top with Mission edge standard
- Available in Rough Sawn Wormy Maple
- Black powder coated metal base
- Base standard as shown with levelers
- Recommended chair: Denver from FN Chairs
- Shown in Rough Sawn Wormy Maple with FC-42000 Almond 10 sheen finish
(Note: Actual color may vary from picture)



AVAILABLE SIZES:

- 42" x 72"
- 42" x 84"
- 42" x 96"
- 48" x 72"
- 48" x 84"
- 48" x 96"

Solid Top Only

EDGE OPTIONS:

MISSION
(STANDARD)

TOP SHAPES:

RECTANGLE

LAREDO TRESTLE shown in Rough Sawn Wormy Maple with FC-42000 Almond 10 sheen finish. Shown with FN Chairs Denver Chairs and West Point Laredo Bench.

(Note: Actual color may vary from picture)



LAREDO BENCH

- 1¾" Rectangle top with Mission edge standard
- Available in Rough Sawn Wormy Maple
- Black powder coated metal base
- Shown in Rough Sawn Wormy Maple with FC-42000 Almond 10 sheen finish
(Note: Actual color may vary from picture)



AVAILABLE SIZES:

- 12 ½" x 72"
 - 12 ½" x 84"
- Solid Top Only

EDGE OPTIONS:

MISSION (STANDARD)

TOP SHAPES:

RECTANGLE

LAURIE'S

- 1" Rectangle top with Mission edge standard
- 4" straight skirt (No option on skirt size due to self store compartment)
- 3" x 3" tapered legs stay stationary like trestle tables when top opens
- Available in Oak, Cherry, Quarter Sawn White Oak & Brown Maple
- Floor to bottom of skirt 25"



AVAILABLE SIZES:

- 42" x 60"
 - 42" x 66"
 - 48" x 60"
 - 48" x 66"
- Up to 4-12" Leaves

Stores 4 unskirted leaves in table

EDGE OPTIONS:

MISSION (STANDARD)

5/8" ROUNDOVER

WATERFALL

BEVEL

CHAMFER

TOP SHAPES:

RECTANGLE (STANDARD)

1" RADIUS CORNER

BOW END

Changing the top shape has an upcharge

LEXINGTON LEG MINI

- 1" Rectangle top with Mission edge standard
- 3" Twist legs standard as shown
- 2½" Straight skirt standard as shown
- Available in Oak, Cherry, Quarter Sawn White Oak, & Brown Maple
- Floor to bottom of skirt 26½"
- Shown in Red Oak with PCL-183 Muted White 10 sheen top and PCL-182 Muted Black 10 sheen base
(Note: Actual color may vary from picture)



EDGE OPTIONS:

- MISSION (STANDARD)
- 5/8" ROUNDOVER
- WATERFALL
- BEVEL
- CHAMFER

TOP SHAPES:

- RECTANGLE (STANDARD)
- 1" RADIUS CORNER
- BOW END

Changing the top shape has an upcharge

AVAILABLE SIZES:

- 36" x 42"
 - 36" x 48"
 - 36" x 54"
 - 42" x 42"
 - 42" x 48"
 - 42" x 54"
- Up to 4-12" Leaves

LEXINGTON LEG

- 1" Rectangle top with Mission edge standard
- 3½" Twist legs standard as shown
- 3½" Straight skirt standard as shown
- Available in Oak, Cherry, Quarter Sawn White Oak, & Brown Maple
- Floor to bottom of skirt 25½"
- Recommended chair: Lawson from Artisan Chairs
- Shown in Brown Maple with FC-15743 Briar top and FC-11434 Driftwood base
(Note: Actual color may vary from picture)



EDGE OPTIONS:

- MISSION (STANDARD)
- 5/8" ROUNDOVER
- WATERFALL
- BEVEL
- CHAMFER

TOP SHAPES:

- RECTANGLE (STANDARD)
- 1" RADIUS CORNER
- BOW END

Changing the top shape has an upcharge

AVAILABLE SIZES:

- 42" x 60"
 - 42" x 66"
 - 42" x 72"
 - 48" x 60"
 - 48" x 66"
 - 48" x 72"
- Up to 4-12" Leaves

LEXINGTON LEG shown
in Brown Maple with
FC-47823 Bel Air top &
FC-230 Onyx base. Shown
with Artisan Lawson Chairs.

*(Note: Actual color may
vary from picture)*



LEXINGTON SINGLE MINI

- 1" Round top with Mission edge standard
- Base standard as shown with levelers
- Available in Oak, Cherry, Quarter Sawn White Oak & Brown Maple
- Floor to bottom of skirt 26½"
- Shown in Red Oak with PCL-185 Weathered Hazelnut 10 sheen top, PCL-184 Weathered Greek Vanilla 10 sheen base
(Note: Actual color may vary from picture)



EDGE OPTIONS:

MISSION (STANDARD)

5/8" ROUNDOVER

WATERFALL

BEVEL

CHAMFER

TOP SHAPES:

ROUND

AVAILABLE SIZES:

- 36" x 36" Round
 - 42" x 42" Round
- Up to 2-12" Leaves

LEXINGTON SINGLE

- 1" Round top with Mission edge standard
- Base standard as shown with levelers
- Available in Oak, Cherry, Quarter Sawn White Oak & Brown Maple
- Quarter Sawn White Oak table will have regular White Oak base
- Floor to bottom of skirt 26½"
- Shown in Brown Maple with FC-42000 Almond 10 sheen top, SP-168 Weathered Beige 10 sheen base
(Note: Actual color may vary from picture)



EDGE OPTIONS:

MISSION (STANDARD)

5/8" ROUNDOVER

WATERFALL

BEVEL

CHAMFER

TOP SHAPES:

ROUND

AVAILABLE SIZES:

- 48" x 48" Round
 - 54" x 54" Round
 - 60" x 60" Round
- Up to 2-12" Leaves
or 1-18" Butterfly Leaf
(BF N/A on 60 x 60)
- 72" x 72" Round
Round Solid Top Only

LEXINGTON SINGLE shown
in Quarter Sawn White Oak
with FC-924 Michaels Cherry
stain. Shown with Artisan
Lemont Chairs

*(Note: Actual color may
vary from picture)*



LEXINGTON TRESTLE

- 1" Rectangle top with Mission edge standard
- Base standard as shown with levelers
- Available in Oak, Cherry, Quarter Sawn White Oak & Brown Maple
- Floor to bottom of skirt 26½"
- Recommended chair: Lawson from Artisan Chairs
- Shown in Rustic Cherry with FC-9018 Lite Asbury 10 sheen finish
(Note: Actual color may vary from picture)



EDGE OPTIONS:

- MISSION (STANDARD)
- 5/8" ROUNDOVER
- WATERFALL
- BEVEL
- CHAMFER

TOP SHAPES:

- RECTANGLE (STANDARD)
- 1" RADIUS CORNER
- BOW END
- 8" SQUARE ROUND
- BOAT
- BANQUET

Changing the top shape has an upcharge and may affect self-store ability

AVAILABLE SIZES:

- 42" x 60"
- 42" x 66"
- 42" x 72"
- 48" x 60"
- 48" x 66"
- 48" x 72"

Up to 4-12" Leaves
or 1-18" Butterfly Leaf
or 2-18" Butterfly Leaves
(2 BF N/A on 42x60 & 48x60)

LEXINGTON CABINET

- 1" Rectangle top with Mission edge standard
- Standard with 1-18" Butterfly Leaf
- Available in Oak, Cherry, Quarter Sawn White Oak & Brown Maple
- Cabinet base size is 26" x 26" (no options)
- 36" high standard. Also available in 30" & 42" high (30" h only has 2 drawers)
- K2040-SN hardware standard
- Floor to bottom of skirt 32½"
- Shown in Brown Maple with FC-17882 Vintage Antique top & FC-230 Onyx base
(Note: Actual color may vary from picture)
- Not available with Round top



AVAILABLE SIZES:

- 42" x 42"
- 42" x 48"
- 42" x 54"
- 48" x 48"
- 48" x 54"

With Solid Top,
1-12" Leaf, or
1-18" Butterfly Leaf

EDGE OPTIONS:

- MISSION (STANDARD)
- 5/8" ROUNDOVER
- WATERFALL
- BEVEL
- CHAMFER

TOP SHAPES:

- RECTANGLE (STANDARD)
- 1" RADIUS CORNER
- BOW END

Changing the top shape has an upcharge

LEXINGTON BENCH

- 1" Rectangle top with Mission edge standard
- 18" high
- Leaf storage box to store all 4 leaves

- Available in Oak, Cherry, Quarter Sawn White Oak & Brown Maple
- Shown in Brown Maple with FC-15743 Briar top & FC-11434 Driftwood base
(Note: Actual color may vary from picture)



AVAILABLE SIZES:

- 12 1/2" x 48"
- 12 1/2" x 60"
- 12 1/2" x 72"

Solid Top or
up to 4-12" Leaves

EDGE OPTIONS:

MISSION
(STANDARD)

TOP SHAPES:

RECTANGLE

LIFESTYLE TRESTLE

- 1 1/2" Rectangle top with Mission edge and grain lengthwise standard
- Black powder coated metal tapered base standard
- Base standard as shown (with levelers)
- Chrome base available
- Available in Oak, Cherry, Quarter Sawn White Oak & Brown Maple
- Also available with Live Edge tops in Rustic Walnut, Rustic Cherry & Wormy Maple



AVAILABLE SIZES:

- 42" x 72"
- 42" x 84"
- 42" x 96"
- 48" x 72"
- 48" x 84"
- 48" x 96"

Solid Top Only

EDGE OPTIONS:

MISSION
(STANDARD)

LIVE/MISSION

TOP SHAPES:

RECTANGLE

LIFESTYLE BENCH

- 1 1/2" Rectangle top with Mission edge standard
- Black powder coated metal base standard
- Chrome color base is available
- Available in Oak, Cherry, Quarter Sawn White Oak & Brown Maple
- Also available with Live Edge top in Rustic Walnut, Rustic Cherry & Wormy Maple
- Shown in Rustic Cherry with Michaels Cherry stain (Note: Actual color may vary from picture)



AVAILABLE SIZES:

- 12 1/2" x 72"
 - 12 1/2" x 84"
- Solid Top Only

EDGE OPTIONS:

MISSION (STANDARD)

LIVE/MISSION

TOP SHAPES:

RECTANGLE

LOGAN TRESTLE

- 1" Rectangle top with Mission edge standard
- Base standard as shown (with levelers)
- Available in Oak, Cherry, Quarter Sawn White Oak & Brown Maple
- Floor to bottom of skirt 26 1/2"
- Shown in Red Oak with FC-10944 Tavern stain (Note: Actual color may vary from picture)



AVAILABLE SIZES:

- 36" x 48"
- 36" x 54"
- 36" x 60"
- 42" x 48"
- 42" x 54"
- 42" x 60"

Up to 3-12" Leaves

EDGE OPTIONS:

MISSION (STANDARD)

5/8" ROUNDOVER

WATERFALL

BEVEL

CHAMFER

TOP SHAPES:

RECTANGLE (STANDARD)

1" RADIUS CORNER

BOW END

Changing the top shape has an upcharge

LOGAN BENCH

- 1" Rectangle top with Mission edge standard
- 18" high
- Leaf storage box to store all 4 leaves
- Available in Oak, Cherry, Quarter Sawn White Oak & Brown Maple
- Shown in Red Oak with FC-42000 Almond stain
(Note: Actual color may vary from picture)



AVAILABLE SIZES:

- 12 1/2" x 48"
- 12 1/2" x 54"
- 12 1/2" x 60"

Solid Top or
up to 3-12" Leaves

EDGE OPTIONS:

MISSION
(STANDARD)

TOP SHAPES:

RECTANGLE

MADISON PUB

- 1" Square top with Mission edge standard
- Arched skirt standard as shown
- 3" x 3" straight legs standard
- Available in Oak, Cherry, Quarter Sawn White Oak & Brown Maple
- Floor to bottom of skirt 30 1/2" at the legs and 32 1/2" at the center
- 36" high standard. Also available in 30" & 42" h



AVAILABLE SIZES:

- 36" Square
 - 42" Square
 - 48" Square
- Up to 3-12" Leaves
or 1-18" Butterfly Leaf
(BF N/A on 36x36)

EDGE OPTIONS:

MISSION
(STANDARD)

5/8" ROUNDOVER

WATERFALL

BEVEL

CHAMFER

TOP SHAPES:

RECTANGLE
(STANDARD)

1" RADIUS
CORNER

Changing the top shape
has an upcharge

MANKATO TRESTLE

- 1" Rectangle top with Mission edge standard
- Base standard as shown with levelers
- Available in Oak, Cherry, Quarter Sawn White Oak & Brown Maple
- Floor to bottom of skirt 26½"
- Shown in Red Oak with FC-15743 Briar finish (Note: Actual color may vary from picture)



EDGE OPTIONS:

- MISSION (STANDARD)
- 5/8" ROUNDOVER
- WATERFALL
- BEVEL
- CHAMFER

TOP SHAPES:

- RECTANGLE (STANDARD)
- 1" RADIUS CORNER
- BOW END
- 8" SQUARE ROUND
- BOAT
- BANQUET

Changing the top shape has an upcharge and may affect self-store ability

AVAILABLE SIZES:

- 42" x 60"
 - 42" x 66"
 - 42" x 72"
 - 48" x 60"
 - 48" x 66"
 - 48" x 72"
- Up to 4-12" Leaves

MANKATO BENCH

- 1 ¼" Rectangle top with Mission edge
- 18" high
- Available in Oak, Cherry, Quarter Sawn White Oak & Brown Maple



AVAILABLE SIZES:

- 12 ½" x 48"
 - 12 ½" x 60"
 - 12 ½" x 72"
- Solid Top Only

EDGE OPTIONS:

- MISSION (STANDARD)

TOP SHAPES:

- RECTANGLE

MANSFIELD

- 1" Boat shape top with Bevel edge standard
- 2 1/2" straight skirt
- 3" x 3" leg as shown
- Available in Oak, Cherry, Quarter Sawn White Oak & Brown Maple
- Floor to bottom of skirt 26 1/2"



AVAILABLE SIZES:

- 42" x 60"
- 42" x 66"
- 42" x 72"
- 48" x 60"
- 48" x 66"
- 48" x 72"

Up to 4-12" Leaves
or 1-18" Butterfly Leaf

EDGE OPTIONS:

MISSION

5/8" ROUNDOVER

WATERFALL

BEVEL
(STANDARD)

CHAMFER

TOP SHAPES:

RECTANGLE

1" RADIUS
CORNER

BOW END

BOAT
(STANDARD)

*Changing the top shape has an upcharge
and may affect self-store ability*

MARTIN TRESTLE PUB

- 1 1/2" Rectangle top with Live edge is standard
- Black powder coated metal base
- 36" high is standard
- Base standard as shown with levelers
- Available in Wormy Maple, Rustic Cherry, & Rustic Walnut
- Every Live edge top is unique and will vary from top to top
- Shown in Rustic Walnut with Natural finish
(Note: Actual color may vary from picture)



AVAILABLE SIZES:

- 42" x 72"
- 42" x 84"
- 42" x 96"
- 48" x 72"
- 48" x 84"
- 48" x 96"

Solid Top Only

EDGE OPTIONS:

LIVE/MISSION
(STANDARD)

TOP SHAPES:

RECTANGLE

McCOY

- 1" Rectangle top with 1" radius corner with Bevel edge standard
- Trestle base is 23 1/2" wide at top & 28" wide at bottom
- Available in Oak, Cherry, Quarter Sawn White Oak & Brown Maple
- Floor to bottom of skirt 26 1/2"



EDGE OPTIONS:

- MISSION
- 5/8" ROUNDOVER
- WATERFALL
- BEVEL (STANDARD)
- CHAMFER

TOP SHAPES:

- RECTANGLE
- 1" RADIUS CORNER (STANDARD)
- BOW END
- 8" SQUARE ROUND
- BOAT
- BANQUET

Changing the top shape has an upcharge and may affect self-store ability

AVAILABLE SIZES:

- 42" x 60"
- 42" x 66"
- 42" x 72"
- 48" x 60"
- 48" x 66"
- 48" x 72"

Up to 4-12" Leaves
or 1-18" Butterfly Leaf
or 2-18" Butterfly Leaves
(2 BF N/A on 42x60 & 48x60)

McCOY BENCH

- 1" Rectangle top with Mission edge standard
- 18" high
- Leaf storage box to store all 4 leaves
- Available in Oak, Cherry, Quarter Sawn White Oak & Brown Maple



EDGE OPTIONS:

- MISSION (STANDARD)

TOP SHAPES:

- RECTANGLE

AVAILABLE SIZES:

- 12 1/2" x 48"
- 12 1/2" x 60"
- 12 1/2" x 72"

Solid Top or
up to 4-12" Leaves

MISSION LEG

- 1" Rectangle top with Mission edge standard
- 3" x 3" Legs with corbels standard
- 2 1/2" straight skirt standard
- Available in Oak, Cherry, Quarter Sawn White Oak & Brown Maple
- Floor to bottom of skirt 26 1/2"



AVAILABLE SIZES:

- 42" x 60"
 - 42" x 66"
 - 42" x 72"
 - 48" x 60"
 - 48" x 66"
 - 48" x 72"
- Up to 4-12" Leaves
or 1-18" Butterfly Leaf

EDGE OPTIONS:

- MISSION (STANDARD)
- 5/8" ROUNDOVER
- WATERFALL
- BEVEL
- CHAMFER

TOP SHAPES:

- RECTANGLE (STANDARD)
- 1" RADIUS CORNER
- BOW END
- BOAT

Changing the top shape has an upcharge and may affect self-store ability

MISSION TRESTLE

- 1" Rectangle top with Mission edge standard
- 2 1/2" straight skirts with corner blocks
- Trestle base is 22" wide
- Available in Oak, Cherry, Quarter Sawn White Oak & Brown Maple
- Floor to bottom of skirt 26 1/2"



AVAILABLE SIZES:

- 42" x 60"
 - 42" x 66"
 - 42" x 72"
 - 48" x 60"
 - 48" x 66"
 - 48" x 72"
- Up to 4-12" Leaves
or 1-18" Butterfly Leaf
or 2-18" Butterfly Leaves
(2 BF N/A on 42x60 & 48x60)

EDGE OPTIONS:

- MISSION (STANDARD)
- 5/8" ROUNDOVER
- WATERFALL
- BEVEL
- CHAMFER

TOP SHAPES:

- RECTANGLE (STANDARD)
- 1" RADIUS CORNER
- BOW END

Changing the top shape has an upcharge

MISSION BENCH

- 1" Rectangle top with Mission edge standard
- 18" high
- Includes leaf storage box that stores all 4 leaves
- Available in Oak, Cherry, Quarter Sawn White Oak & Brown Maple



AVAILABLE SIZES:

- 12 1/2" x 48"
 - 12 1/2" x 60"
 - 12 1/2" x 72"
- Solid Top or
up to 4-12" Leaves

EDGE OPTIONS:

MISSION
(STANDARD)

TOP SHAPES:

RECTANGLE

NAPERVILLE TRESTLE

- 1" Bow End top with Waterfall edge standard
- Base standard as shown with levelers
- Available in Oak, Cherry, Quarter Sawn White Oak & Brown Maple
- Floor to bottom of skirt 26 1/2"

- Recommended chair: Naperville from Artisan Chairs
- Shown in Quarter Sawn White Oak with Michaels Cherry stain (*Note: Actual color may vary from picture*)



AVAILABLE SIZES:

- 42" x 60"
 - 42" x 66"
 - 42" x 72"
 - 48" x 60"
 - 48" x 66"
 - 48" x 72"
- Up to 4-12" Leaves
or 1-18" Butterfly Leaf
or 2-18" Butterfly Leaves
(2 BF N/A on 42x60 & 48x60)

EDGE OPTIONS:

MISSION

5/8" ROUNDOVER

WATERFALL
(STANDARD)

BEVEL

CHAMFER

TOP SHAPES:

RECTANGLE

1" RADIUS
CORNER

BOW END
(STANDARD)

8" SQUARE
ROUND

BOAT

BANQUET

*Changing the top shape has an upcharge
and may affect self-store ability*

NASHVILLE TRESTLE

- 1" Bow End top with Waterfall edge standard
- Base standard as shown with levelers
- Available in Oak, Cherry, Quarter Sawn White Oak & Brown Maple
- Floor to bottom of skirt 26½"
- Shown in Brown Maple with FC-40592 Earthtone stain (*Note: Actual color may vary from picture*)



AVAILABLE SIZES:

- 42" x 60"
 - 42" x 66"
 - 42" x 72"
 - 48" x 60"
 - 48" x 66"
 - 48" x 72"
- Up to 4-12" Leaves
or 1-18" Butterfly Leaf
or 2-18" Butterfly Leaves
(2 BF N/A on 42x60 & 48x60)

EDGE OPTIONS:

- MISSION
- 5/8" ROUNDOVER
- WATERFALL (STANDARD)
- BEVEL
- CHAMFER

TOP SHAPES:

- RECTANGLE
- 1" RADIUS CORNER
- BOW END (STANDARD)
- 8" SQUARE ROUND
- BOAT
- BANQUET

Changing the top shape has an upcharge and may affect self-store ability

NASHVILLE BENCH

- 1" Rectangle top with Mission edge standard
- 18" high
- Leaf storage box to store all 4 leaves
- Available in Oak, Cherry, Quarter Sawn White Oak & Brown Maple
- Shown in Rustic Hickory with FC-42000 Almond stain (*Note: Actual color may vary from picture*)



AVAILABLE SIZES:

- 12 ½" x 48"
 - 12 ½" x 60"
 - 12 ½" x 72"
- Solid Top or
up to 4-12" Leaves

EDGE OPTIONS:

- MISSION (STANDARD)

TOP SHAPES:

- RECTANGLE

NEWBURY

- 1" Bow End top with Bevel edge standard
- 2 1/2" straight skirt
- Legs standard as shown
- Available in Oak, Cherry, Quarter Sawn White Oak & Brown Maple
- Floor to bottom of skirt 26 1/2"
- Recommended chair: Newbury from Artisan Chairs

EDGE OPTIONS:

MISSION

5/8" ROUNDOVER

WATERFALL

BEVEL
(STANDARD)

CHAMFER

TOP SHAPES:

RECTANGLE

1" RADIUS
CORNER

BOW END
(STANDARD)

BOAT

Changing the top shape has an upcharge and may affect self-store ability

AVAILABLE SIZES:

- 42" x 60"
- 42" x 66"
- 42" x 72"
- 48" x 60"
- 48" x 66"
- 48" x 72"

Up to 4-12" Leaves
or 1-18" Butterfly Leaf



NEWBURY BENCH

- 1" Bow End top with Bevel edge standard
- 18" high
- Includes leaf storage box that stores all 4 leaves
- Available in Oak, Cherry, Quarter Sawn White Oak & Brown Maple

AVAILABLE SIZES:

- 12 1/2" x 48"
- 12 1/2" x 60"
- 12 1/2" x 72"

Solid Top or
up to 4-12" Leaves



EDGE OPTIONS:

BEVEL
(STANDARD)

TOP SHAPES:

BOW END



NEWBURY shown in Brown Maple with FC-924 Michaels Cherry top & FC-230 Onyx base. Shown with Artisan Newbury Chairs.

(Note: Actual color may vary from picture)



OLDE CENTURY MISSION

- 1" Rectangle top with Mission edge standard
- Skirt standard with half-lap corner joints
- Trestle base is 24" wide
- Available in Oak, Cherry, Quarter Sawn White Oak & Brown Maple
- Floor to bottom of skirt 26½"
- Recommended chair: Olde Century from Artisan Chairs



AVAILABLE SIZES:

- 42" x 60"
- 42" x 66"
- 42" x 72"
- 48" x 60"
- 48" x 66"
- 48" x 72"

Up to 4-12" Leaves
or 1-18" Butterfly Leaf
or 2-18" Butterfly Leaves
(2 BF N/A on 42x60 & 48x60)

EDGE OPTIONS:

MISSION (STANDARD)

5/8" ROUNDOVER

WATERFALL

BEVEL

CHAMFER

TOP SHAPES:

RECTANGLE (STANDARD)

1" RADIUS CORNER

BOW END

Changing the top shape has an upcharge

OLDE CENTURY BENCH

- 1" Rectangle top with Mission edge standard
- Includes leaf storage box that stores all 4 leaves
- Available in Oak, Cherry, Quarter Sawn White Oak & Brown Maple



AVAILABLE SIZES:

- 12 ½" x 48"
- 12 ½" x 60"
- 12 ½" x 72"

Solid Top or
up to 4-12" Leaves

EDGE OPTIONS:

MISSION (STANDARD)

TOP SHAPES:

RECTANGLE

OREWOOD TRESTLE Shown
in Rough Sawn Wormy Ma-
ple with FC-42000 Almond
10 sheen finish. Shown with
Artisan Orowood Chairs

*(Note: Actual color may
vary from picture)*



OREWOOD TRESTLE

- 1¼" Rectangle top with Mission edge standard
- Base standard as shown with levelers
- Available in Rough Sawn Wormy Maple and Rough Sawn White Oak
- Floor to bottom of skirt 26½"
- Shown in Rough Sawn Wormy Maple with FC-42000 Almond 10 sheen finish (Note: Actual color may vary from picture)



AVAILABLE SIZES:

- 42" x 60"
 - 42" x 72"
 - 48" x 60"
 - 48" x 72"
- Up to 4-12" Leaves

EDGE OPTIONS:

MISSION (STANDARD)

TOP SHAPES:

RECTANGLE

OXFORD DOUBLE

- 1½" Rectangle top with Live Edge standard
- Black powder coated metal base
- Base standard as shown with levelers
- Available in Wormy Maple, Rustic Cherry & Rustic Walnut
- Every Live edge top is unique and will vary from top to top
- Shown in Wormy Maple with FC-47823 Bel Air stain (Note: Actual color may vary from picture)



AVAILABLE SIZES:

- 36" x 84"
 - 36" x 96"
 - 42" x 84"
 - 42" x 96"
- Solid Top Only

EDGE OPTIONS:

LIVE/MISSION (STANDARD)

TOP SHAPES:

RECTANGLE

PAGOSA TRESTLE

- 1½" top with Live edge standard
- Black powder coated metal base
- Base standard as shown (with levelers)
- Available in Wormy Maple, Rustic Cherry & Rustic Walnut
- Every Live edge top is unique and will vary from top to top
- Shown in Rustic Walnut with Natural finish *(Note: Actual color may vary from picture)*



AVAILABLE SIZES:

- 42" x 72"
- 42" x 84"
- 42" x 96"
- 48" x 72"
- 48" x 84"
- 48" x 96"

Solid Top Only

EDGE OPTIONS:

LIVE/MISSION
(STANDARD)

TOP SHAPES:

RECTANGLE

PAGOSA BENCH

- 1½" top with Live edge is standard
- Black powder coated metal base
- Available in Wormy Maple, Rustic Cherry, & Rustic Walnut
- Every Live edge top is unique and will vary from top to top
- Shown in Rustic Walnut with Natural finish *(Note: Actual color may vary from picture)*



AVAILABLE SIZES:

- 12 ½" x 72"
- 12 ½" x 84"

Solid Top Only

EDGE OPTIONS:

LIVE/MISSION
(STANDARD)

TOP SHAPES:

RECTANGLE

PLYMOUTH LEG DROP LEAF

- 1" Rectangle top with Mission edge standard
- 2 - 12" drop leaves standard
- 3" x 3" Tapered legs standard as shown (optional legs: Lexington Mini, Straight or Traditional)
- Legs standard as shown with levelers
- Available in Oak, Cherry, Quarter Sawn White Oak & Brown Maple
- Floor to bottom of skirt 26½"
- 20 7/8" between legs on sides
- Shown in Red Oak with FC-42000 Almond stain
(Note: Actual color may vary from picture)



EDGE OPTIONS:

MISSION (STANDARD)

5/8" ROUNDOVER

WATERFALL

BEVEL

CHAMFER

TOP SHAPES:

RECTANGLE

AVAILABLE SIZES:

- 36" x 32"
(36" x 56" with leaves up)
 - 42" x 32"
(42" x 56" with leaves up)
- Solid top or up to
4-12" Center Leaves

PORTLAND SINGLE

- 1" Round top with Mission edge standard
- Base standard as shown with levelers
- Available in Oak, Cherry, Quarter Sawn White Oak & Brown Maple
- Floor to bottom of skirt 26½"
- Shown in Rustic Cherry with FC-44688 Medium Walnut finish
(Note: Actual color may vary from picture)



AVAILABLE SIZES:

- 48" x 48" Round
 - 54" x 54" Round
 - 60" x 60" Round
- Up to 2-12" Leaves
or 1-18" Butterfly Leaf
(BF N/A on 60x60)

EDGE OPTIONS:

MISSION (STANDARD)

5/8" ROUNDOVER

WATERFALL

BEVEL

CHAMFER

TOP SHAPES:

ROUND

PRESTON DOUBLE

- 1" Oval top with Roundover edge standard
- Base standard as shown with levelers
- Available in Oak, Cherry, Quarter Sawn White Oak & Brown Maple
- Floor to bottom of skirt 26½"



AVAILABLE SIZES:

- 42" x 60"
 - 42" x 66"
 - 42" x 72"
 - 48" x 60"
 - 48" x 66"
 - 48" x 72"
- Up to 4-12" Leaves

EDGE OPTIONS:

MISSION

5/8" ROUND OVER
(STANDARD)

WATERFALL

BEVEL

CHAMFER

TOP SHAPES:

RECTANGLE

1" RADIUS
CORNER

BOW END

OVAL
(STANDARD)

BOAT

BANQUET

*Changing the top shape has an upcharge
and may affect self-store ability*

PRESTON SINGLE

- 1" Round top with Roundover edge standard
- Base standard as shown with levelers
- Available in Oak, Cherry, Quarter Sawn White Oak & Brown Maple
- Floor to bottom of skirt 26½"



AVAILABLE SIZES:

- 42" x 42" Round
 - 48" x 48" Round
- Up to 2-12" Leaves
or 1-18" Butterfly Leaf
(BF N/A on 42x42)

EDGE OPTIONS:

MISSION

5/8" ROUND OVER
(STANDARD)

WATERFALL

BEVEL

CHAMFER

TOP SHAPES:

ROUND

RAVENA TRESTLE

- 1" Rectangle top with Bevel edge standard
- Base standard as shown (with levelers)
- Available in Oak, Cherry, Brown Maple & Quarter Sawn White Oak
- Floor to bottom of skirt 26½"
- Shown in Brown Maple with FC-42633 Manchester stain (Note: Actual color may vary from picture)



AVAILABLE SIZES:

- 42" x 60"
- 42" x 66"
- 42" x 72"
- 48" x 60"
- 48" x 66"
- 48" x 72"

Up to 4-12" Leaves
 or 1-18" Butterfly Leaf
 or 2-18" Butterfly Leaves
 (2 BF N/A on 42x60 & 48x60)

EDGE OPTIONS:

- MISSION
- 5/8" ROUNDOVER
- WATERFALL
- BEVEL (STANDARD)
- CHAMFER

TOP SHAPES:

- RECTANGLE (STANDARD)
- 1" RADIUS CORNER
- BOW END
- 8" SQUARE ROUND
- BOAT
- BANQUET

Changing the top shape has an upcharge and may affect self-store ability

RENO BENCH

- 1" Rectangle top with Mission edge standard
- 18" high
- Leaf storage box to store up to 4 leaves
- Available in Oak, Cherry, Quarter Sawn White Oak & Brown Maple



AVAILABLE SIZES:

- 12 ½" x 48"
- 12 ½" x 60"
- 12 ½" x 72"

Solid Top or
 up to 4-12" Leaves

EDGE OPTIONS:

- MISSION (STANDARD)

TOP SHAPES:

- RECTANGLE

RENO TRESTLE

- 1" Bow End top with Waterfall edge standard
- Base standard as shown with levelers
- Available in Oak, Cherry, Quarter Sawn White Oak & Brown Maple
- Floor to bottom of skirt 26½"
- Recommended chair: Reno from Artisan Chairs

AVAILABLE SIZES:

- 42" x 60"
- 42" x 66"
- 42" x 72"
- 48" x 60"
- 48" x 66"
- 48" x 72"

Up to 4-12" Leaves
 or 1-18" Butterfly Leaf
 or 2-18" Butterfly Leaves
 (2 BF N/A on 42x60 & 48x60)



EDGE OPTIONS:

MISSION

5/8" ROUNDOVER

WATERFALL
(STANDARD)

BEVEL

CHAMFER

TOP SHAPES:

RECTANGLE

1" RADIUS
CORNER

BOW END
(STANDARD)

8" SQUARE
ROUND

BOAT

BANQUET

Changing the top shape has an upcharge and may affect self-store ability



RENO TRESTLE shown in Cherry with Michael's Cherry stain. Shown with Reno Chairs from Artisan Chairs.

(Note: Actual color may vary from picture)

RICHLAND TRESTLE

- 1" top with 1" radius rectangle and 5/8" Roundover edge standard
- Base standard as shown with levelers
- Available in Oak, Cherry, Quarter Sawn White Oak & Brown Maple
- Floor to bottom of skirt 26½"
- Shown in Sap Cherry with FC-10748 Burnt Umber stain (Note: Actual color may vary from picture)



EDGE OPTIONS:

- MISSION
- 5/8" ROUNDROVER (STANDARD)
- WATERFALL
- BEVEL
- CHAMFER

TOP SHAPES:

- RECTANGLE
- 1" RADIUS CORNER (STANDARD)
- BOW END
- 8" SQUARE ROUND
- BOAT
- BANQUET

Changing the top shape has an upcharge and may affect self-store ability

AVAILABLE SIZES:

- 42" x 60"
- 42" x 66"
- 42" x 72"
- 48" x 60"
- 48" x 66"
- 48" x 72"

Up to 4-12" Leaves
or 1-18" Butterfly Leaf
or 2-18" Butterfly Leaves
(2 BF N/A on 42x60 & 48x60)

RIDGECREST

- 1" Rectangle top with Mission edge standard
- Base standard as shown with levelers
- Available in Oak, Cherry, Quarter Sawn White Oak & Brown Maple
- Floor to bottom of skirt 26½"



EDGE OPTIONS:

- MISSION (STANDARD)
- 5/8" ROUNDROVER
- WATERFALL
- BEVEL
- CHAMFER

TOP SHAPES:

- RECTANGLE (STANDARD)
- 1" RADIUS CORNER
- BOW END
- 8" SQUARE ROUND
- BOAT
- BANQUET

Changing the top shape has an upcharge and may affect self-store ability

AVAILABLE SIZES:

- 42" x 66"
- 42" x 72"
- 48" x 66"
- 48" x 72"

Up to 4-12" Leaves

RIDGEWOOD

- 1" Round top with Mission edge standard
- Base standard as shown with levelers
- Available in Oak, Cherry, Quarter Sawn White Oak & Brown Maple
- Floor to bottom of skirt 26½"



AVAILABLE SIZES:

- 42" x 42" Round
 - 48" x 48" Round
 - 54" x 54" Round
- Up to 2-12" Leaves
or 1-18" Butterfly Leaf
(BF N/A on 42x42)

EDGE OPTIONS:

MISSION
(STANDARD)

5/8" ROUNDOVER

WATERFALL

BEVEL

CHAMFER

TOP SHAPES:

ROUND

SANTA FE BENCH

- 1¾" Rectangle top with Mission edge standard
- Available in Rough Sawn Wormy Maple
- Shown in Rough Sawn Wormy Maple with FC-42000 Almond 10 sheen finish
(Note: Actual color may vary from picture)



AVAILABLE SIZES:

- 12 ½" x 48"
- 12 ½" x 60"
- 12 ½" x 72"

Solid Top or
up to 4-12" Leaves

EDGE OPTIONS:

MISSION
(STANDARD)

TOP SHAPES:

RECTANGLE

SANTA FE LEG

- 1¾" Rectangle top with Mission edge standard
- Available in Rough Sawn Wormy Maple
- Recommended chair: Houston from FN Chairs
- Floor to bottom of skirt 25½"
- Shown in Rough Sawn Wormy Maple with FC-42000 Almond 10 sheen finish
(Note: Actual color may vary from picture)



AVAILABLE SIZES:

- 42" x 60"
 - 42" x 66"
 - 42" x 72"
 - 48" x 60"
 - 48" x 66"
 - 48" x 72"
- Up to 3-16" Leaves

EDGE OPTIONS:

MISSION
(STANDARD)

TOP SHAPES:

RECTANGLE



SANTA FE LEG shown in Rough Sawn Wormy Maple with FC-42000 Almond 10 sheen finish. Shown with FN Chairs Houston chairs.

(Note: Actual color may vary from picture)

SARATOGA TRESTLE

- 1 ¼" Semi-Boat shape top standard
- Edge standard as shown
- Base standard as shown with levelers
- Available in Oak, Cherry, Quarter Sawn White Oak & Brown Maple
- Floor to bottom of skirt 26½"

AVAILABLE SIZES:

- 42" x 72"
 - 48" x 72"
- Up to 4-12" Leaves



EDGE
OPTIONS:
AS SHOWN
IN PHOTO

TOP SHAPES:
AS SHOWN
IN PHOTO



SARATOGA TRESTLE shown in Brown Maple with Autumn Leaf top & Onyx base. Shown with FN Chairs Brookfield chairs in Brown Maple finished with an Onyx stain and Linen fabric.

(Note: Actual color may vary from picture)

SAVANNAH SINGLE

- 1" Round top with 5/8" Roundover edge standard
- Base standard as shown with levelers
- Available in Oak, Cherry, Quarter Sawn White Oak & Brown Maple
- Floor to bottom of skirt 26½"

- Shown in Brown Maple with SP-156 Worn Spice Med-Dis. 10 sheen top and SP-167 Weathered Tusk Med-Dis. 10 sheen base
(Note: Actual color may vary from picture)



AVAILABLE SIZES:

- 42" x 42" Round
 - 48" x 48" Round
- Up to 2-12" Leaves
or 1-18" Butterfly Leaf
(BF N/A on 42x42)

EDGE OPTIONS:

MISSION

5/8" ROUND OVER
(STANDARD)

WATERFALL

BEVEL

CHAMFER

TOP SHAPES:

ROUND

SHELBY TRESTLE

- 1" Bow End top with Waterfall edge standard
- Base standard as shown with levelers
- Available in Oak, Cherry, Quarter Sawn White Oak & Brown Maple
- Floor to bottom of skirt 26½"
- Shown in Sap Cherry with FC-48024 American Antique finish
(Note: Actual color may vary from picture)



AVAILABLE SIZES:

- 36" x 48"
 - 36" x 54"
 - 36" x 60"
 - 42" x 48"
 - 42" x 54"
 - 42" x 60"
- Up to 3-12" Leaves



EDGE OPTIONS:

MISSION

5/8" ROUND OVER

WATERFALL
(STANDARD)

BEVEL

CHAMFER

TOP SHAPES:

RECTANGLE

1" RADIUS
CORNER

BOW END
(STANDARD)

Changing the top shape
has an upcharge

SHERIDAN TRESTLE shown
in Red Oak with
D22N08963 Sandstone stain.
Shown with FN Abe Chairs.

*(Note: Actual color may
vary from picture)*



SHERIDAN TRESTLE

- 1" Bow End top with Chamfer edge standard
- Base standard as shown (has levelers)
- Available in Oak, Cherry, Quarter Sawn White Oak & Brown Maple
- Floor to bottom of skirt 26½"



AVAILABLE SIZES:

- 36" x 48"
 - 36" x 54"
 - 36" x 60"
 - 42" x 48"
 - 42" x 54"
 - 42" x 60"
- Up to 3-12" Leaves

EDGE OPTIONS:

MISSION

5/8" ROUNDOVER

WATERFALL

BEVEL

CHAMFER
(STANDARD)

TOP SHAPES:

RECTANGLE

1" RADIUS
CORNER

BOW END
(STANDARD)

Changing the top shape
has an upcharge

SHERIDAN BENCH

- 1" Rectangle top with Mission edge standard
- 18" high
- Leaf storage box to store all 4 leaves
- Available in Oak, Cherry, Quarter Sawn White Oak & Brown Maple
- Shown in Red Oak with Asbury Brown stain
(Note: Actual color may vary from picture)



AVAILABLE SIZES:

- 12 ½" x 48"
 - 12 ½" x 60"
 - 12 ½" x 72"
- Solid Top or
up to 3-12" Leaves

EDGE OPTIONS:

MISSION
(STANDARD)

TOP SHAPES:

RECTANGLE

SIERRA

- 1" Rectangle top with Mission edge standard
- Base standard as shown with levelers
- Available in Oak, Cherry, Quarter Sawn White Oak & Brown Maple
- Floor to bottom of skirt 26½"
- Recommended chair: Sierra from Artisan Chairs



AVAILABLE SIZES:

- 42" x 60"
 - 42" x 66"
 - 42" x 72"
 - 48" x 60"
 - 48" x 66"
 - 48" x 72"
- Up to 4-12" Leaves
or 1-18" Butterfly Leaf
or 2-18" Butterfly Leaves
(2 BF N/A on 42x60 & 48x60)

EDGE OPTIONS:

- MISSION (STANDARD)
- 5/8" ROUNDOVER
- WATERFALL
- BEVEL
- CHAMFER

TOP SHAPES:

- RECTANGLE (STANDARD)
- 1" RADIUS CORNER
- BOW END
- 8" SQUARE ROUND
- BOAT
- BANQUET

Changing the top shape has an upcharge and may affect self-store ability

SONOMA SINGLE

- 1¼" Round top with Waterfall edge standard
- Base standard as shown with levelers
- Available in Oak, Cherry, Quarter Sawn White Oak & Brown Maple
- Floor to bottom of skirt 26½"
- Shown in Brown Maple with FC-24427 Shadow top & SP-170 Weathered Snow White 10 sheen base
(Note: Actual color may vary from picture)



AVAILABLE SIZES:

- 48" x 48" Round
 - 54" x 54" Round
 - 60" x 60" Round
- Up to 2-12" Leaves
- 72" x 72" Round
Round Solid Top Only

EDGE OPTIONS:

- MISSION
- 5/8" ROUNDOVER
- WATERFALL (STANDARD)
- BEVEL
- CHAMFER

TOP SHAPES:

- ROUND

STANWOOD

- 1¼" Rectangle top with Mission edge standard
- 4" x 4" leg standard as shown
- 3½" straight skirt
- Available in Oak, Cherry, Quarter Sawn White Oak & Brown Maple
- Floor to bottom of skirt 25½"

EDGE OPTIONS:

MISSION (STANDARD)

5/8" ROUNDOVER

WATERFALL

BEVEL

CHAMFER

TOP SHAPES:

RECTANGLE (STANDARD)

1" RADIUS CORNER

BOW END

Changing the top shape has an upcharge

AVAILABLE SIZES:

- 42" x 60"
- 42" x 66"
- 42" x 72"
- 48" x 60"
- 48" x 66"
- 48" x 72"

Up to 4-12" Leaves



TRADITIONAL DOUBLE

- Oval top with Roundover edge standard
- Classic Empire feet standard as shown with levelers, also available with claw feet
- Bar spreader standard as shown, Spindle Rail is also available
- Available in Oak, Cherry, Quarter Sawn White Oak & Brown Maple
- Available as an extension table with up to 12 leaves with drop legs that support both ends
- Floor to bottom of skirt 26½"

EDGE OPTIONS:

MISSION

5/8" ROUNDOVER (STANDARD)

WATERFALL

BEVEL

CHAMFER

TOP SHAPES:

RECTANGLE

1" RADIUS CORNER

BOW END

OVAL (STANDARD)

BOAT

BANQUET

Changing the top shape has an upcharge and may affect self-store ability

AVAILABLE SIZES:

- 42" x 60"
- 42" x 66"
- 42" x 72"
- 48" x 60"
- 48" x 66"
- 48" x 72"

Up to 4-12" Leaves



Claw Feet



Spindle Rail

TRADITIONAL LEG

- Rectangle top with 4" corner radius and Roundover edge standard
- Table skirt standard as shown
- Non-geared wooden slides
- Available in Oak, Cherry, Quarter Sawn White Oak & Brown Maple
- Floor to bottom of skirt 24½" at the legs and 26½" at the center



AVAILABLE SIZES:

- 42" x 60"
 - 42" x 66"
 - 42" x 72"
 - 48" x 60"
 - 48" x 66"
 - 48" x 72"
- Up to 4-12" Leaves
or 1-18" Butterfly Leaf

EDGE OPTIONS:

MISSION

5/8" ROUND OVER
(STANDARD)

WATERFALL

BEVEL

CHAMFER

TOP SHAPES:

RECTANGLE

4" RADIUS
CORNER
(STANDARD)

BOW END

*Changing the top shape
has an upcharge*

TRADITIONAL PUB

- 1" Round solid top with Roundover edge standard
- Classic empire feet standard as shown with levelers, also available with claw feet
- Available in Oak, Cherry, Quarter Sawn White Oak & Brown Maple
- 36" high standard. Also available in 30" & 42" h
- Floor to bottom of skirt 32½"



AVAILABLE SIZES:

- 36" x 36" Round
 - 42" x 42" Round
 - 48" x 48" Round
- Solid Top Only

EDGE OPTIONS:

MISSION

5/8" ROUND OVER
(STANDARD)

WATERFALL

BEVEL

CHAMFER

TOP SHAPES:

ROUND

TRADITIONAL SCALLOP

- 1" Scallop Oval top with Bevel edge standard
- Classic empire feet standard as shown with levelers, also available with claw feet
- Spindle rail also available
- Available in Oak, Cherry, Quarter Sawn White Oak & Brown Maple
- Floor to bottom of skirt 26½"



EDGE OPTIONS:

- MISSION
- 5/8" ROUNDOVER
- WATERFALL
- BEVEL (STANDARD)
- CHAMFER

TOP SHAPES:

- RECTANGLE
- 1" RADIUS CORNER
- BOW END
- SCALLOP OVAL (STANDARD)
- BOAT
- BANQUET

Changing the top shape has an upcharge and may affect self-store ability

AVAILABLE SIZES:

- 42" x 60"
 - 42" x 66"
 - 42" x 72"
 - 48" x 60"
 - 48" x 66"
 - 48" x 72"
- Up to 4-12" Leaves

TRADITIONAL SINGLE

- Round top with Roundover edge standard
- Classic empire feet standard as shown with levelers, also available with claw feet
- Available in Oak, Cherry, Quarter Sawn White Oak & Brown Maple
- Floor to bottom of skirt 26½"



EDGE OPTIONS:

- MISSION
- 5/8" ROUNDOVER (STANDARD)
- WATERFALL
- BEVEL
- CHAMFER

TOP SHAPES:

- ROUND

AVAILABLE SIZES:

- 36" x 36" Round
 - 42" x 42" Round
 - 48" x 48" Round
- Up to 2-12" Leaves
or 1-18" Butterfly Leaf
(BF N/A on 36x36 or 42x42)

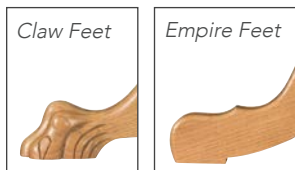

TULSA CABINET

- 1¾" Rectangle top with Mission edge standard
- Available in Rough Sawn Wormy Maple
- Cabinet base is 36" w x 25" d (no options on cabinet size)
- Standard with 3 drawers and sliding door with adjustable shelves (no options)
- 36" high standard also available 42" high
- Floor to bottom of skirt 32½"
- Shown in Rough Sawn Wormy Maple with SP-166 Weathered Treebark 10 sheen top and SP-167 Weathered Tusk 10 sheen base
(Note: Actual color may vary from picture)

AVAILABLE SIZES:

- 42" x 60"
 - 42" x 72"
 - 48" x 60"
 - 48" x 72"
- Up to 2-16" Leaves



EDGE OPTIONS:

MISSION
(STANDARD)

TOP SHAPES:

RECTANGLE

TULSA CABINET shown in Rough Sawn Wormy Maple with SP-166 Weathered Treebark 10 sheen top and SP-167 Weathered Tusk 10 sheen base. Shown with FN Chairs Houston Bar Stools.

(Note: Actual color may vary from picture)



VANCOUVER TRESTLE

- 1" Bow End top with Mission edge standard
- Base standard as shown with levelers
- Available in Oak, Cherry, Quarter Sawn White Oak & Brown Maple

- Floor to bottom of skirt 26½"
- See below for expanded views and leaf detail for optional butterfly leaves

EDGE OPTIONS:

- MISSION (STANDARD)
- 5/8" ROUNDOVER
- WATERFALL
- BEVEL
- CHAMFER

TOP SHAPES:

- RECTANGLE
- 1" RADIUS CORNER
- BOW END (STANDARD)
- 8" SQUARE ROUND
- BOAT
- BANQUET

Changing the top shape has an upcharge and may affect self-store ability

AVAILABLE SIZES:

- 42" x 60"
- 42" x 66"
- 42" x 72"
- 48" x 60"
- 48" x 66"
- 48" x 72"

Up to 4-12" Leaves
or 1-18" Butterfly Leaf
or 2-18" Butterfly Leaves
(2 BF N/A on 42x60 & 48x60)



Shown with 1 leaf



Shown with 2 leaves

Butterfly leaf storage detail



WABASH BARREL

- 1¼" Round top with Mission edge standard
- Base standard as shown (with levelers)
- 36" high standard
- Black powder coated metal base
- Available in Oak, Cherry, Quarter Sawn White Oak & Brown Maple

- Floor to bottom of skirt 32½"
- Shown in Rustic Hickory with FC-44688 Medium Walnut finish
(Note: Actual color may vary from picture)

AVAILABLE SIZES:

- 48" x 48" Round
- 54" x 54" Round
- Up to 2-12" Leaves



EDGE OPTIONS:

MISSION (STANDARD)

5/8" ROUNDOVER

WATERFALL

BEVEL

CHAMFER

TOP SHAPES:

ROUND

WABASH BARREL shown in Rustic Hickory with FC-44688 Medium Walnut stain. Shown with Artisan Wabash Chairs.

(Note: Actual color may vary from picture)



WELLINGTON TRESTLE

- 3" edge band top with random grooves and breadboard ends (no grooves in leaves)
- 1/4" Roundover edge and corners
- Ball bearing slides are standard
- Base standard as shown with levelers
- Available in Oak, Cherry, Quarter Sawn White Oak & Brown Maple
- Not available in Grey Elm, Hickory or Rustic Hickory



AVAILABLE SIZES:

- 42" x 88"
- 48" x 88"
- Up to 2-16" Leaves

EDGE OPTIONS:

1/4" ROUND OVER (STANDARD)

TOP SHAPES:

1/4" RADIUS CORNER

WELLINGTON TRESTLE shown in Brown Maple with a 3" edge band top in SP-156 Worn Spice Med. Distressed 10 sheen stain. Shown with FN Chairs Ramsey chairs.

(Note: Actual color may vary from picture)



WESTIN

- 1¼" Round top with Mission edge standard
- Base standard as shown with levelers
- Available in Oak, Cherry, Quarter Sawn White Oak & Brown Maple
- Quarter Sawn White Oak tables will have regular White Oak base
- Floor to bottom of skirt 26½"

AVAILABLE SIZES:

- 42" x 42" Round
 - 48" x 48" Round
 - 60" x 60" Round
- Up to 2-12" Leaves



EDGE OPTIONS:

MISSION (STANDARD)

5/8" ROUNDOVER

WATERFALL

BEVEL

CHAMFER

TOP SHAPES:

ROUND

XAVIER BENCH

- 1½" Rectangle top with Live Edge standard
- Black powder coated metal base
- Available in Wormy Maple, Rustic Walnut & Rustic Cherry
- Every Live edge top is unique and will vary from top to top

AVAILABLE SIZES:

- 12 ½" x 72"
 - 12 ½" x 84"
- Solid Top Only



EDGE OPTIONS:

MISSION

LIVE/MISSION (STANDARD)

TOP SHAPES:

RECTANGLE

XAVIER TRESTLE

- 1½" top with Live edge standard
- Black powder coated metal base
- Base standard as shown (with levelers)
- Available in Wormy Maple, Rustic Walnut & Rustic Cherry
- Every Live edge top is unique and will vary from top to top



AVAILABLE SIZES:

- 42" x 72"
- 42" x 84"
- 42" x 96"
- 48" x 72"
- 48" x 84"
- 48" x 96"

Solid Top Only

EDGE OPTIONS:

MISSION

LIVE/MISSION
(STANDARD)

TOP SHAPES:

RECTANGLE



XAVIER TRESTLE shown in Rustic Walnut with FC-47823 Bel Air stain. Shown with FN Sheldon Chairs.

(Note: Actual color may vary from picture)

Home of West Point Woodworking, LLC

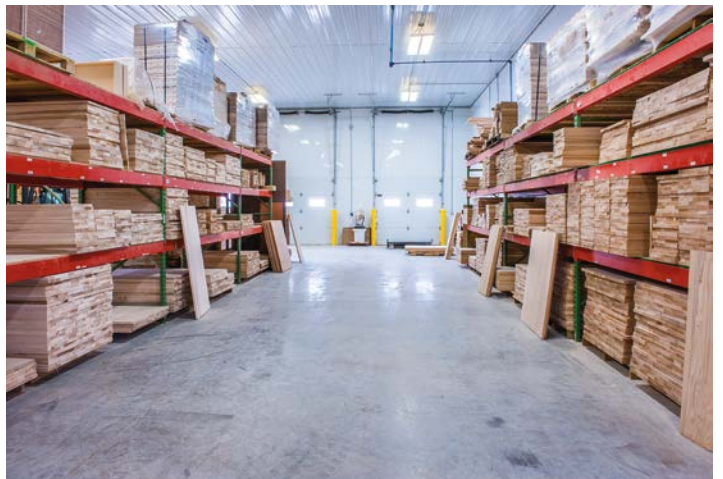

West Point 
WOODWORKING LLC