

2026

FD

FUSION DESIGNS

Handcrafted solid wood furniture, made in the Heartland.



FUSION DESIGNS

EST. 1995

What began as a simple woodworking shop has grown into a trusted source of fine, quality-crafted furniture for every room in the home.

For 2024, we are excited to be able to offer new collections created in the heart of Amish country, most produced and all artfully finished right here in our shop under our strict attention to detail. It's our way of honoring our heritage while pursuing new heights in innovative designs for the future.

We invite you to experience Fusion Designs.

Noah Bontrager

THESE ARE PRINCIPLES
THAT GUIDE US:

QUALITY

Unsurpassed quality standards.

CRAFTSMANSHIP

*A work ethic instilled by
generations of skilled craftsmen.*

INNOVATION

*A dedication to honor the past
and design for the future.*

LIFETIME GUARANTEE

We don't make it complicated. If your properly cared for furniture fails during normal use in the lifetime of the original owner due to problems in either the workmanship or material, we'll repair or replace it for free.

We can do this because we are confident that what we build will last.



FUSION DESIGNS

EST. 1995

CONTENTS

FEATURES, OPTIONS, & CARE	16
Special Table Tops	17
• Plank Tops	
• Live Edge Glue-Up	
Seating	25
Fabrics & Leathers.....	28
Hardware Options.....	29
Bedroom	31
Wood Care.....	32
Wood Species & Finishes.....	33
Paint Program Display.....	36
Display Units	39
Internet Policy	40
DINING	41
Dining Collections.....	42
SEATING	111
Chairs	112
Desk Chairs	118
Barstools	119
Benches.....	140
STORAGE	143
Hutches	144
Buffets/Sideboards.....	147
LIVING ROOM	153
Living Room Collections	154
• Sofa Tables	
• Coffee Tables	
• End Tables	
ENTERTAINMENT & MEDIA CONSOLE	172
Media Consoles	173
OFFICE	176
Office Collections	177
BEDROOM	185
Bedroom Collections	186

ABOUT US

Fusion Designs is a leader in solid wood case goods made from locally harvested American hardwoods, producing furniture for bedroom, dining room, occasional, entertainment and home office.

Rooted in Amish culture and high-quality construction techniques, Fusion Designs honors its past by individually crafting and hand-finishing its products, while designing for today's lifestyles and aesthetics. Since its founding by Noah Bontrager, the company has built an expansive portfolio of modern and transitional styles, staying ahead of the trend curve by designing both in-house and partnering with world-class furniture designers.

Based in the heartland, Fusion Designs delivers its solid wood, handmade furniture to retailers nationwide, serving some of the largest names in the industry from Top 100 dealers Furniture Row and Living Spaces to smaller independents who look to the family owned and operated company for its customization capabilities and a responsive customer service team that intimately understands their needs.

Led by the second generation and one of the youngest presidents in the industry, Marcus Bontrager heads the in-house design team, inspired by his innate understanding of the needs and desires of a new generation of shoppers. To balance consumers' hunger for personalized looks and innovative features combined with fast shipping, Bontrager eventually shifted to a cellular manufacturing approach that has helped the company shrink lead times and enable quick delivery of bench-built products.

Fueling the company's continued rise is the popular and continually expanding Essentials program. With 65 employees using the same hand-building construction techniques on which the company built its reputation, the Essentials program offers bedroom, dining, entertainment and home office furniture in a choice of 35 finishes, shipped to dealers within 10 business days.

From the start, a focus on innovation has been another key factor in Fusion Designs' growth and success. As the story goes, founder Noah Bontrager got his start in the business making furniture as a hobby while working in the RV industry. Over time, he learned the finer points of construction through trial and error and working alongside generations of talented Amish craftspeople in the region. The fresh perspective he brought to his growing business led to the introduction of a number of industry-leading (and much copied) features, including the butterfly table leaf and ball-bearing slides. In fact, to achieve the superior quality he was after, Bontrager has developed and custom-built proprietary manufacturing equipment for the Fusion Designs 80,000-square-foot manufacturing facility that are unique among case goods manufacturers.

Founded in 1995, Fusion Designs specializes in high-quality, American-made solid wood, built-to-order case goods collections for bedroom, dining room, home office and entertainment sold to leading retailers across the U.S. Handcrafted in Indiana from domestically sourced wood species like oak, maple, cherry and hickory available in a choice of 35 finishes, the expansive portfolio of contemporary, transitional and mid-century modern designs is set apart by mortise and tenon construction techniques, upscale features like soft-close drawers and finishes that highlight the natural beauty of the woods, as well as a lifetime warranty.



For more information, visit fusiondesign.us



THE FUSION DIFFERENCE

At Fusion Designs, we place our emphasis on attention to detail. We strive to bring out the natural beauty and character of each piece of wood. As a result, these one-of-a-kind pieces built with quality workmanship ensure many years of retained beauty and endurance that can be passed on from generation to generation.

Built in the USA

Fusion Designs is putting American people to work! All of our products are handcrafted in our workshop in Goshen, Indiana.

Quality Construction

We take pride in everything we build.

Customizable – Wood & Finish

Choose from 7 kinds of wood and 25 finish options.

Fully Cartoned

Our products are completely cartoned to help prevent damage and delivered to your doorstep.

Quick Lead Time

We work quickly, without sacrificing quality with every order we receive. Therefore, we have a 6-7 week production times for all custom orders.

Quickship Programs

We understand that your showroom or a customer may need products sooner than our standard 6-7 week production time, therefore, we stock our top-selling products and ship in 10 days.

Dealer Protection

We protect our dealers and give them a radius against competitors.

Great Customer Service

Contact us directly anytime during working hours and we will answer any questions you may have.

Lifetime Warranty

You will need to register with us as the original owner of Fusion Design furniture.

Responsibility & Sustainability

Fusion Designs works hard to lower our carbon footprint by employing a variety of responsible practices.



THE NATURE OF WOOD AND ITS ENVIRONMENT

Hardwood forests cover more than 269 million acres in the United States. Although it takes about 80 years for a tree to mature, natural reseeded and sprouting contribute to the regeneration of our forests. Conscientious caretakers are also responsible for the ongoing rebirth of this country's hardwood resource thanks to the use of a practice known as sustained yield forest management. Thanks to this practice, the United States grows twice as much hardwood as it harvests every year. In fact, current projections show that by the year 2040, the U.S. will have about 70% more hardwoods available for harvest.

Conservation has long been a byword for the wood industry, both in the forest and in manufacturing. Lumber mills use approximately 98% of the entire tree harvested. Thanks to the introduction of laser-guided saws, improved quality control and computer-assisted manufacturing, virtually nothing is wasted. The bark, which can constitute up to 20% of a log, often fuels the mill. Bark also is used to produce mulches and soil conditioners, while trimmings are processed into a variety of wood products, including paper.

Our trees are an ever-renewing gift from nature. A vibrant hardwood forest is a dynamic force, contributing to a clean, healthy environment. Forests cool the atmosphere and filter the water we drink. They convert carbon dioxide into oxygen to give us air to breathe. They provide food and shelter for wildlife and offer a spectacular variety of recreational opportunities. Each Autumn, their green leaves burst into brilliant symphonies of amber, orange, magenta, and thousands of hues in between.

U.S. hardwoods are coveted all over the world for their warmth and lasting beauty in furniture, cabinetry, mill work, and flooring. In finished products, hardwoods are the purest expression of nature. They are not synthetic, nor are they engineered. Their beauty is not just skin deep.

HARDWOODS

Hardwoods include broad-leafed trees like oak, walnut, cherry, maple, hickory, and dozens of other species. Mature hardwoods supply the nation, and much of the world, with timber used for everything from railroad ties to quality furnishings.

Just as each tree is different from the next, so, too, are hardwood products individually unique. Hardwoods are characterized by an infinite variety of grains and distinctive textures. Trees grow limbs that fall off as the tree matures. What remains is a knot on the hardwood surface. These natural markings add character to the wood's appearance and have absolutely no effect on the wood's durability and stability.

At Fusion Designs, we strive to bring out the natural beauty and character of each piece of wood. These characteristics give each piece its unique charm. As a result, even though the finishing processes are identical, no two pieces will ever be exactly the same. Embrace the uniqueness of your hardwood furniture. It's what nature intended.

REFORESTATION INITIATIVE

We are proud to be partnering with Onetreeplanted.org, a non-profit organization with a focus on restoring the world's forests by planting one tree at a time. We partner by giving a portion of every order towards planting trees all over the world. Through this organization, it takes only \$1 to plant a tree! Go to onetreeplanted.org to learn more.



"When trees mature, it is fair and moral that they are cut for man's use, as they would soon decay and return to the earth. Trees have the yearning to live again, perhaps to provide beauty, strength and utility to serve man and even to become an object of great artistic worth."

George Nakashima
(Master woodworker and renowned leader in 20th century furniture design)

PLACING YOUR ORDER



Easy Steps to Create Your Order

Follow the Steps Below, Copy Your sku Number to the Corresponding Boxes Below. Once Complete, Remove Blank Spaces to Create the sku

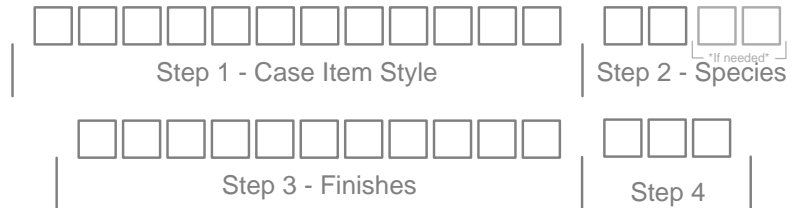

1 - Select Style
Enter product Code or Item #

2 - Wood Species

3a - Finish Colors

Standard	115 - Harbor Gray	72 - Mocha	124 - Soft Brown	Premium	46 - White
30 - Asbury	68 - Hazelnut	53 - Natural	99 - Toffee	114 - Aged Mineral	45 - New Century (Distressed)
51 - Autumn	33 - Medium	113 - Oatmeal	126 - Velvet Dusk	59 - Antique Black	74 - Rustic Bourbon (Distressed)
65 - Chocolate	32 - Michaels	58 - Peanut	123 - Warm Brown	44 - Black	
103 - Dew				86 - Shale	
118 - Flannel					

3b - Add 2nd Color (optional)*
Enter Seat Color Code ___ followed by "2 T N"

3c - Add Distressed Feature (optional)*
2D - Distressed Finish Option

*Base and Top will be Two Different Colors

Case Goods

Easy Steps to Create Your Order

Follow the Steps Below, Copy Your sku Number to the Corresponding Boxes Below. Once Complete, Remove Blank Spaces to Create the sku



1 - Select Style

Enter product Code or Item #

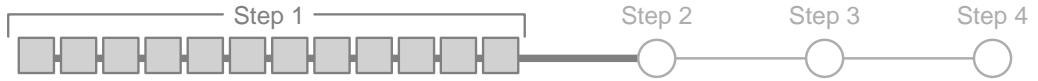

2 - Wood Species



- | | | | | | | |
|---------------------------------|---------------|-----------------------|------------------|-------------------------|--------------------------|----------------------------|
| 01 Quartersawn White Oak | 02 Oak | 03 Brown Maple | 04 Cherry | 05 Rustic Cherry | 06 Rustic Hickory | 07 Rustic White Oak |
|---------------------------------|---------------|-----------------------|------------------|-------------------------|--------------------------|----------------------------|

Case Goods

3a - Finish Colors



Standard

- | | | |
|----------------|-------------------|---------------|
| 30 - Asbury | 115 - Harbor Gray | 72 - Mocha |
| 51 - Autumn | 68 - Hazelnut | 53 - Natural |
| 65 - Chocolate | 33 - Medium | 113 - Oatmeal |
| 103 - Dew | 32 - Michaels | 58 - Peanut |
| 118 - Flannel | | |

Premium

- | | |
|--------------------|----------------------------------|
| 114 - Aged Mineral | 46 - White |
| 59 - Antique Black | 45 - New Century (Distressed) |
| 44 - Black | 74 - Rustic Bourbon (Distressed) |
| 86 - Shale | |

3b - Add 2nd Color (optional)*

Enter Seat Color Code ___ followed by "2 T N"

*Base and Top will be Two Different Colors



3c - Add Distressed Feature (optional)*

2D - Distressed Finish Option



...More Customization

Follow the Steps Below, Copy Your sku Number to the Corresponding Boxes Below. Once Complete, Remove Blank Spaces to Create the sku

Step 1

Step 2

Step 3

Step 4

4 Hardware

**Leave blank if standard hardware*

Pulls



A-1 Satin Nickel, 5 1/2"



A-2
Oil Rubbed
Bronze
5 1/2"



A-3
Windover
Antique
5 1/2"

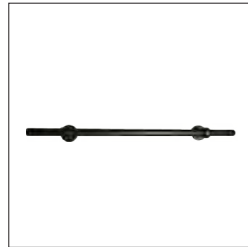

BH-1 Black Iron, 12"



F-6 Satin Nickel, 5 1/2"

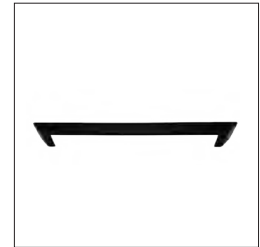

L-25 Black, 1 1/4"



K-11 Satin Nickel, 3 3/4"



K-12
Veneti
Bronze
3 3/4"



M-2 Gold, 5 3/4"



P-16 Bright Nickel Brushed Dull, 3 3/4"



R-18 Satin Nickel, 4 1/2"

R-2 Satin Nickel, 6"



T-25 Black Iron, 4 1/2"



U-2 Oil Rubbed Bronze, 3 3/4"



V-25 Satin Nickel, 6 7/8"



X-2 Satin Nickel, 5 1/8"



X-1
Oil
Rubbed
Bronze
5 1/8"



Y-2 Oil Rubbed Bronze Dull, 4"

Case Goods



...More Customization

Follow the Steps Below, Copy Your sku Number to the Corresponding Boxes Below. Once Complete, Remove Blank Spaces to Create the sku

4 Hardware

**Leave blank if standard hardware*

Knobs



A-25 Black, 1 3/4"



B-2 Satin Nickel, 1 3/4"



B-3
Oil Rubbed
Bronze
1 3/4"



B-4
Windover
Antique
1 3/4"



BH-2 Black Iron, 1 1/2"



C-3 Antique English, 3 3/4"



C-4
Black
Iron
3 3/4"



D-4 Antique English, 1 1/4"



D-5
Black
Iron
1 1/4"



E-5 Oil Rubbed Bronze, 1 1/4"



E-6
Antique
English
1 1/4"

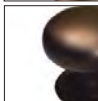

E-8
Dark Brushed
Antique Copper
1 1/4"



E-9
Satin
Nickel
1 1/4"



I-9 Black or Finished, 1 1/4"



J-10 Black Iron, 1 1/4"



M-1 Gold, 1 1/8"



N-14 Black or Finished, 1 1/2"



Q-17 Bright Nickel Brushed Dull, 1 1/4"



SO-1 Antique Brass, 3 1/4"



U-1 Oil Rubbed Bronze, 1 1/4"



Y-1 Oil Rubbed Bronze Dull



Z-4 Satin Nickel, 1 1/4"



Z-3
Brushed Oil
Rubbed Bronze
1 1/4"



Z-5
Pewter
1 1/4"

Case Goods



...More Customization

Follow the Steps Below, Copy Your sku Number to the Corresponding Boxes Below. Once Complete, Remove Blank Spaces to Create the sku

4 Hardware

**Leave blank if standard hardware*

Pulls



H-8 Black, 3 3/4" x 2"



B-25 Bronze, 2 1/8"



M-13 Black, 1" x 3 3/4"



S-19 Antique English, 3 1/2" x 1 1/2"



W-1 Black, 1 1/4" x 4 1/2"



W-3
Oil Rubbed
Bronze



W-4
Antique
Copper



W-2 Black, 1 1/4" x 4 1/2"



W-6
Oil Rubbed
Bronze



W-7
Antique
Copper

Easy Steps to Create Your Order

Follow the Steps Below, Copy Your sku Number to the Corresponding Boxes Below. Once Complete, Remove Blank Spaces to Create the sku



Step 1 - Seating Style

Step 2 - Species

Step 3 - Finishes

Step 4 - Upholstery Style

Seating

1 - Select Seating Style

Use complete chair sku. Sku's that end in "W" signify a wood seat. If your chair has a fabric seat the "W" will be replaced with a "F" or "L" for an upgrade to leather.
 Example "CCSCW" would become CCSCF if ordering a leather seat instead of wood.

2 - Wood Species

Step 1 Step 2 Step 3 Step 4

01 Quartersawn White Oak 02 Oak 03 Brown Maple 04 Cherry 05 Rustic Cherry 06 Rustic Hickory 07 Rustic White Oak

3a - Finish Colors

Step 1 Step 2 Step 3 Step 4

Standard

30 - Asbury	115 - Harbor Gray	72 - Mocha	124 - Soft Brown	Premium	46 - White
51 - Autumn	68 - Hazelnut	53 - Natural	99 - Toffee	114 - Aged Mineral	45 - New Century (Distressed)
65 - Chocolate	33 - Medium	113 - Oatmeal	126 - Velvet Dusk	59 - Antique Black	74 - Rustic Bourbon (Distressed)
103 - Dew	32 - Michaels	58 - Peanut	123 - Warm Brown	44 - Black	
118 - Flannel				86 - Shale	

3b - Add 2nd Color (optional)*

Enter Seat Color Code ___ followed by "2 T N"

*Chair/Bench Frame and Top will be Two Different Colors



3c - Add Distressed Feature (optional)*

2D - Distressed Finish Option



4 - Select Upholstery Style*

*Skip if you Chose a Wood Seat

Fabric Colors

Enter Number for Fabric only in Sku Boxes

Leather Colors

- BLK - Black
- BONE - Bone
- CML - Camel
- GRAY - Gray

- MAH - Mahogany
- MSRM - Mushroom
- PCN - Pecan
- RUM - Rum

- GRN - Tapestry
- TXS - Texas
- WSKY - Whiskey
- WBL - Windsor Blue



Easy Steps to Create Your Order

Follow the Steps Below, Copy Your sku Number to the Corresponding Boxes Below. Once Complete, Remove Blank Spaces to Create sku



Tables



1 Select Table Style

Enter Product Code or Item # *
*Use Base Style Code if Opting for the "Build Your Own" Package



2 Leaf Options

Enter Quantity of Leaves
12 - 12" Wide leaf

Optional Upgrade
B - Upgrade to butterfly leaf



3 Wood Species

- 01
Quartersawn
White Oak
- 02
Oak
- 03
Brown
Maple
- 04
Cherry
- 05
Rustic
Cherry
- 06
Rustic
Hickory
- 07
Rustic
White Oak

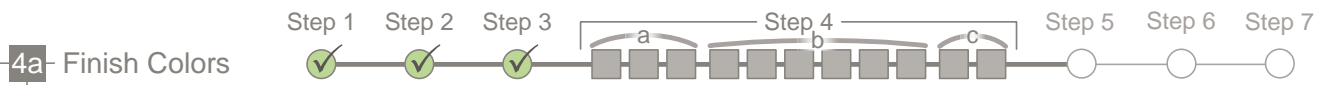

4a Finish Colors

- | | | | | | |
|--|---|---|---|--|---|
| <p>Standard</p> <ul style="list-style-type: none"> 30 - Asbury 51 - Autumn 52 - Chilton 65 - Chocolate 116 - Cider | <ul style="list-style-type: none"> 103 - Dew 118 - Flannel 115 - Harbor Gray 68 - Hazelnut 33 - Medium | <ul style="list-style-type: none"> 32 - Michaels 70 - Mocha 53 - Natural 113 - Oatmeal 49 - Onyx | <ul style="list-style-type: none"> 58 - Peanut 100 - Pebble 99 - Toffee 54 - Washington | <p>Premium</p> <ul style="list-style-type: none"> 114 - Aged Mineral 59 - Antique Black 44 - Black 86 - Shale | <ul style="list-style-type: none"> 46 - White 45 - New Century (Distressed) 74 - Rustic Bourbon (Distressed) |
|--|---|---|---|--|---|



4b Add 2nd Color (optional)*

Enter Base Color Code ___ followed by "2 T N"

*Table Base and Top Will be Two Different Colors



4c Add Distressed Option (optional)

2D - Distress Finish Option



5 Select Table Shape

*Custom top shape only available on Classic table. All other options, fill in standard shape.







- TM - Mission
- TSR - Square Round
- TBS - Boat
- TT - Tapered
- TBT - Banquet
- TR - Round
- TO - Oval



...More Customization









Follow the Steps Below to Maximize Your Customization Options. Once Complete, Transfer the sku Code to the Other Side of This Page. Remove Any Blank Spaces (Where Applicable)

6 Select Edge Profile Step 1 ✓ Step 2 ✓ Step 3 ✓ Step 4 ✓ Step 5 ✓ Step 6 Step 7

EB - Beveled 	EU - Underbevel 	EC - Chamfered 
EM - Mission 	ER - Roundover 	EO - Ogee 

7 More Customization Step 1 ✓ Step 2 ✓ Step 3 ✓ Step 4 ✓ Step 5 ✓ Step 6 Step 7

Optional Leg Upgrade* *Skip if Staying with Standard Leg As Shown in Catalog

							
L1 Brookline	L2 Englewood	L3 Farmer	L7 Mission	L8 Regular	L9 Round Shaker	CCTB Shaker	L4 Hoosier

Important Delivery Info

When shipping, table tops, leaves, and bases are all boxed separately to avoid damage. The table top box will have the complete sku that you have entered. The leaf box also has the same sku but is prefixed by the number (2-). The base will come with the sku prefixed with the number (3-)

- Table Top - (Full sku)
- Table Base - (3-Full sku)



FEATURES, OPTIONS & CARE

Customized beauty and the proper care of your furniture will enhance its place in your home and assure that it can endure the test of time. Your furniture can be handed from generation to generation to become a

TIME-HONORED
FAMILY
HEIRLOOM.

DINING FEATURES & OPTIONS

TRESTLE TABLE SELF-STORING FEATURES

42" x 60"
With Skirt: 0
Without Skirt: 4

42" x 66"
With Skirt: 0
Without Skirt: 4



48" x 60"
With Skirt: 2
Without Skirt: 2

48" x 66"
With Skirt: 2
Without Skirt: 2

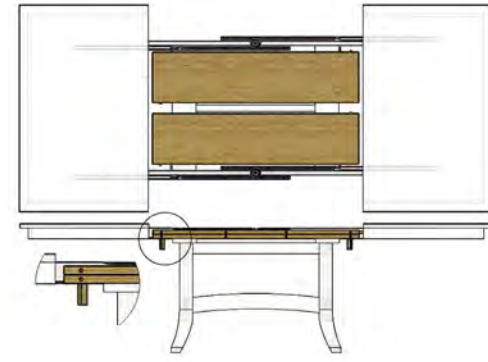

42" x 72"
With Skirt: 2
Without Skirt: 2

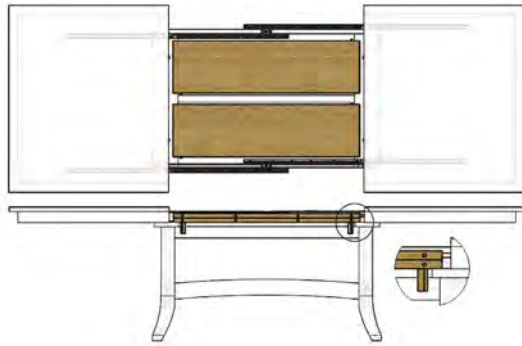

48" x 72"
With Skirt: 0
Without Skirt: 4

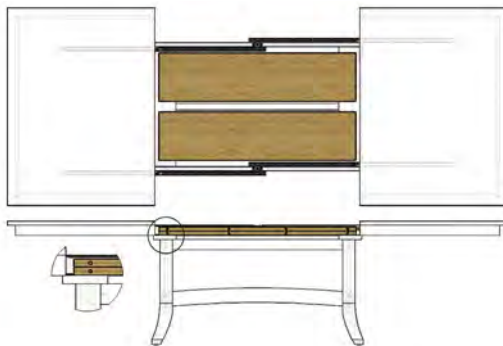

TABLE TOP STANDARD FEATURES



12" Table leaves can be stored inside the table to save valuable time and space.



Dining table legs are connected by a reinforced V-grooved corner block with 2 bolts.



1" solid wood table tops are fitted with steam-bent skirts.



Mortise and tenon construction adds strength to each piece.



Each dining table is number-branded and signed by the craftsman who created your individual piece.



Each dining table's unique leaves receive that table's serial number and numerical label for installation.

PREMIUM SLIDE SYSTEM UPGRADE

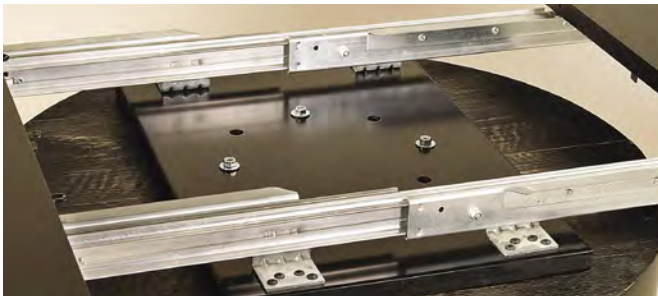

These slides are second to none and well worth the upgrade! Slides will not warp or bind over time and will work as good in 40 years as the day they were installed. *BBS slides are not available on round tables with butterfly style leaves.

INLAY OPTION



Hayworth Inlay can be added to any top. Option includes 1 inlay at each end of table (2 inlays).

CENTER LEG GUIDELINES FOR WOOD SLIDES

36" & 42" Wide Rules: When adding 32" - 84" in leaves, table receives 1 center leg. When adding 84" - 120" in leaves, table receives 2 doubles (4 legs). When adding 120"+, table receives 1 double and 2 singles (4 legs).

48" Wide Rules: 32" - 48" in leaves, table receives 1 center leg. When adding 48" - 84" in leaves, table receives 1 double (2 legs). When adding 84" - 120" in leaves, table receives 2 doubles (4 legs). When adding 120"+, table receives 1 double and 2 singles (4 legs).

Solid Top Rules: 84" and longer receive 1 center leg.

CENTER LEG GUIDELINES FOR BBS SLIDES

36" & 42" Wide Rules: When adding 32" - 84" in leaves, table receives 1 center leg. When adding 84" - 120" in leaves, table receives 2 doubles (4 legs). When adding 120"+, table receives 1 double and 2 singles (4 legs).

48" Wide Rules: 17" - 48" in leaves, table receives 1 center leg. When adding 48" - 84" in leaves, table receives 1 double (2 legs). When adding 84" - 120" in leaves, table receives 2 doubles (4 legs). When adding 120"+, table receives 1 double and 2 singles (4 legs).

Solid Top Rules: 84" and longer receive 1 center leg.

BUTTERFLY LEAF DETAILS



Butterfly leaf round tables cannot be built using aprons on leaves or have BBS slides. Round tops with butterfly leaves are also not available any smaller than 42" in diameter. Butterfly leaf tables are not available in custom sizes. *Butterfly leaves are not available on any thickness other than 1".

SELF STORING SPECIFICATIONS

All tables will be built to self-store and leaf skirt will be added accordingly. If tables cannot self-store (all round or square tables), skirt will be added to leaves as a standard feature. Leaf skirt can be requested for all leaves but must be specified at time of order placement and may void self-storing, see the following rules:

- Self-store is not available on round or square table tops unless using 1" butterfly leaves.
- 1 3/8" thick tops can only self-store 1 leaf without skirt.
- Trestle tables and double pedestal tables with 1" thick top can store as follows: 36" wide will store 2-12" leaves, 42" wide will store 4-12" leaves, 2 with skirt and 2 without; 48" wide will store 4-12" leaves, all without skirt. Any double pedestal or trestle tables that is less than 72" long will only store 2 without skirt. Boat or Oval tops can only self store 2 leaves, 1 with skirt and 1 without.
- Leg tables with 1" thick top can store as follows: 36" wide will store 2-12" leaves without skirt, 42" wide will store 4-12" leaves, 2 with skirt and 2 without, 1 with skirt and 1 without; 48" wide will store 4-12" leaves, 2 with skirt and 2 without, 1 with skirt and 1 without; Boat or Oval tops can only self-store 2 leaves, 1 with skirt and 1 without; 42"x60" and 42"x66" leg tables with BBS slides can only self-store 2-12" leaves, 1 with skirt and 1 without.



Leaf and table locks can be added to tables and leaves in order to hold table together however tables will no longer be able to self-store leaves.

ALL ESSENTIALS+ ITEMS FEATURE HIGH END BALL BEARING TABLE SLIDES & NEW MAGNETIC TABLE LOCKS

Introducing:

The revolutionary new **MAGNETIC LEAF LOCKS** from Fusion Designs! Say goodbye to the hassle of using traditional leaf locks that interfere with self-storing features and require additional steps to use. With our innovative magnetic leaf locks, you can easily and seamlessly extend or retract your table leaves without any fuss.

Our magnetic leaf locks are built right into the edge of your table leaves, holding them securely in place during use. No more wobbling or shifting, just a stable and sturdy surface for you and your guests to enjoy. And when it's time to store your leaves, simply retract them back into the table and store them until needed.

As the first in the industry to offer this game-changing feature, Fusion Designs is proud to provide our customers with the ultimate in convenience and functionality. Our magnetic leaf locks are designed to work seamlessly with our wide range of high-quality tables, so you can enjoy the benefits of this innovative technology no matter what style or size of table you choose.

These magnetic locks will be standard on all Essentials Plus tables and be paired with our ball bearing table slides.

Don't settle for the hassle and inconvenience of traditional leaf locks. Upgrade to Fusion Designs' magnetic leaf locks today and experience the ultimate in convenience, functionality, and style!

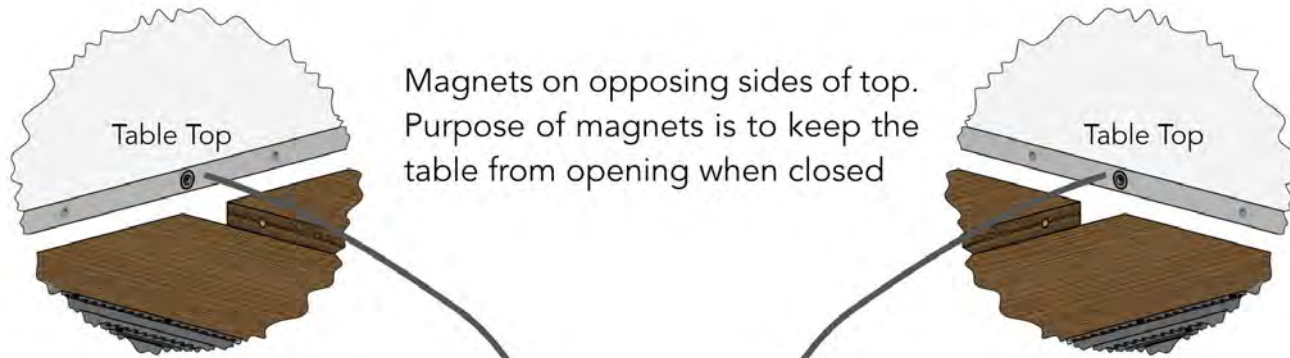

Showing table top in open position with table extension leaves in storing position inside table



DINING FEATURES & OPTIONS

EDGE PROFILES

Edge options available on Classic table at no charge, all other tables will be built with standard edge

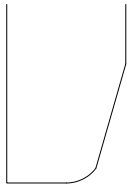

Bevel #EB

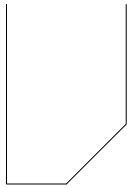

Chamfer #EC



Mission #EM

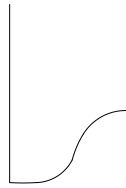

Ogee #EO

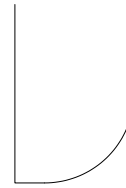

Roundover #ER

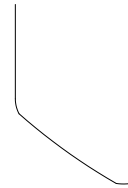

Underbevel #EU

TABLE TOP SHAPES

Dining table tops are available in the sizes listed below. See bases for amount of leaves each size will accommodate.

Table shape options are only available on the Classic Table. All other tables will be built with the top shape listed as standard and do not have optional shapes.

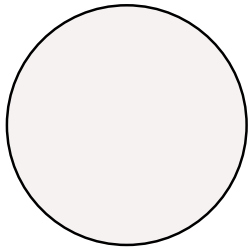

Round #TR

36" x 36"
42" x 42"
48" x 48"
54" x 54"
60" x 60"
72" x 72"

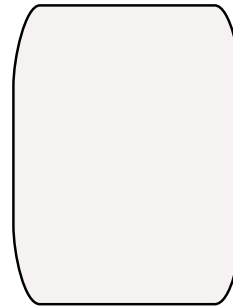

Boat Shape #TBS

36" x 36"	42" x 66"	48" x 72"
36" x 48"	42" x 72"	48" x 84"
36" x 54"	42" x 84"	48" x 96"
36" x 60"	42" x 96"	54" x 54"
42" x 42"	48" x 48"	60" x 60"
42" x 54"	48" x 60"	72" x 72"
42" x 60"	48" x 66"	

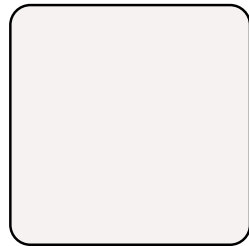

Square-Round #TSR

36" x 36"	42" x 66"	48" x 72"
36" x 48"	42" x 72"	48" x 84"
36" x 54"	42" x 84"	48" x 96"
36" x 60"	42" x 96"	54" x 54"
42" x 42"	48" x 48"	60" x 60"
42" x 54"	48" x 60"	72" x 72"
42" x 60"	48" x 66"	

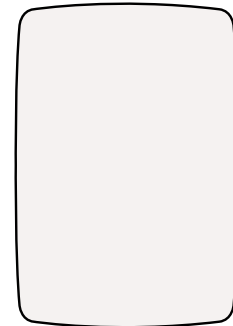

Banquet #TBT

36" x 36"	42" x 66"	48" x 72"
36" x 48"	42" x 72"	48" x 84"
36" x 54"	42" x 84"	48" x 96"
36" x 60"	42" x 96"	54" x 54"
42" x 42"	48" x 48"	60" x 60"
42" x 54"	48" x 60"	72" x 72"
42" x 60"	48" x 66"	

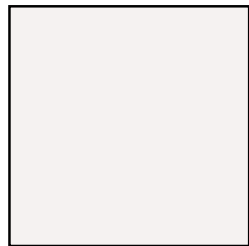

Mission #TM

36" x 36"	42" x 66"	48" x 72"
36" x 48"	42" x 72"	48" x 84"
36" x 54"	42" x 84"	48" x 96"
36" x 60"	42" x 96"	54" x 54"
42" x 42"	48" x 48"	60" x 60"
42" x 54"	48" x 60"	72" x 72"
42" x 60"	48" x 66"	

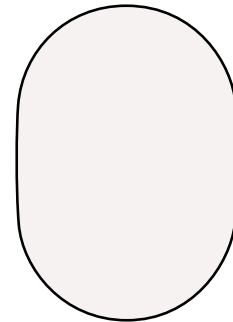

Oval #TR

36" x 48"	42" x 84"
36" x 54"	42" x 96"
36" x 60"	48" x 60"
42" x 54"	48" x 66"
42" x 60"	48" x 72"
42" x 66"	48" x 84"
42" x 72"	48" x 96"

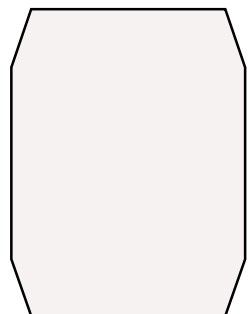

Tapered #TT

36" x 36"	42" x 66"	48" x 72"
36" x 48"	42" x 72"	48" x 84"
36" x 54"	42" x 84"	48" x 96"
36" x 60"	42" x 96"	54" x 54"
42" x 42"	48" x 48"	60" x 60"
42" x 54"	48" x 60"	72" x 72"
42" x 60"	48" x 66"	



Bennett Dining Table

TABLE BASE OPTIONS

LEGS

Maximum extended size with leaves installed for leg bases is 216" in length. Any leg table over 2 leaves will have a center leg added for support. Round or oval tops will be built with square skirt.



L1 Brookline L2 Englewood L3 Farmer L7 Mission L8 Regular L9 Round Shaker CCTB L10 Shaker CHTB Copenhagen
*Base not available in anything other than 30" height EATB Elara

SINGLE PEDESTALS

Maximum extended size with leaves installed for these bases is 66" in length.

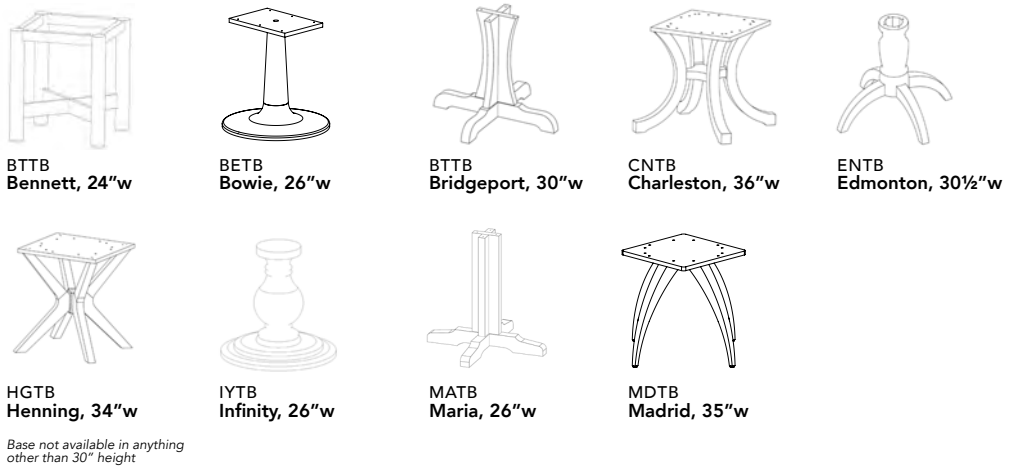

BTTB Bennett, 24"w BETB Bowie, 26"w BTTB Bridgeport, 30"w CNTB Charleston, 36"w ENTB Edmonton, 30½"w
 HGTB Henning, 34"w IYTB Infinity, 26"w MATB Maria, 26"w MDTB Madrid, 35"w

Base not available in anything other than 30" height

Maximum extended size with leaves installed for these bases is 72" in length.

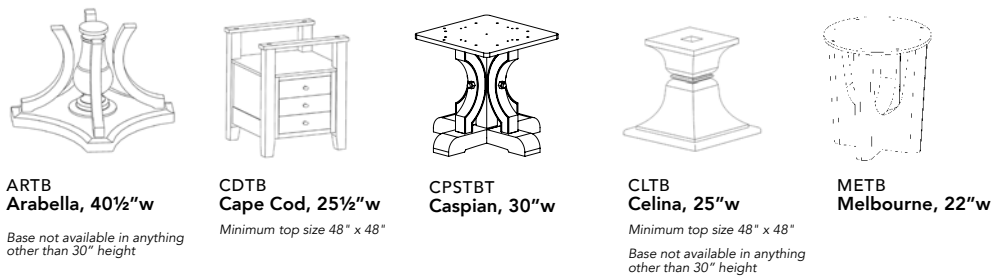

ARTB Arabella, 40½"w CDTB Cape Cod, 25½"w CPSTB Caspian, 30"w CLTB Celina, 25"w METB Melbourne, 22"w
Minimum top size 48" x 48"
Minimum top size 48" x 48"
Base not available in anything other than 30" height

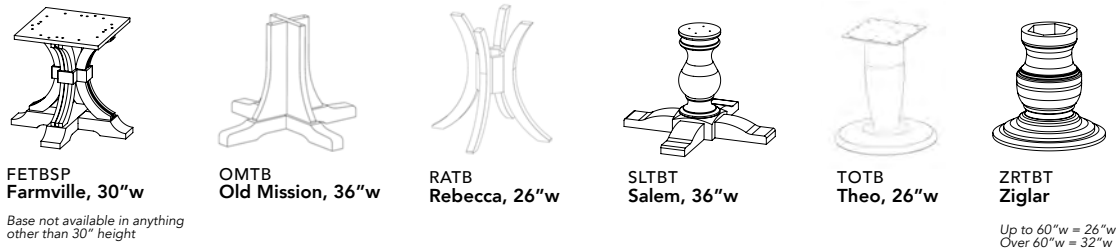

FETBSP Farmville, 30"w OMTB Old Mission, 36"w RATB Rebecca, 26"w SLTBT Salem, 36"w TOTB Theo, 26"w ZRTBT Ziglar
Base not available in anything other than 30" height
Up to 60" w = 26" w
Over 60" w = 32" w

Maximum extended size with leaves installed for these bases is 192" in length.

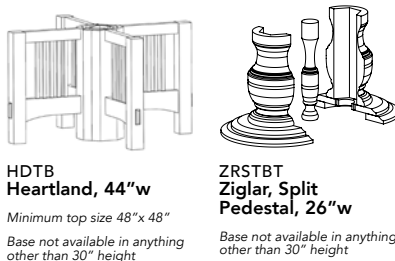

HDTB Heartland, 44"w ZRSTBT Ziglar Split Pedestal, 26"w
Minimum top size 48" x 48"
Base not available in anything other than 30" height
Base not available in anything other than 30" height

TABLE BASE OPTIONS

DOUBLE PEDESTALS

Maximum extended size with leaves installed for this base is 120" in length.

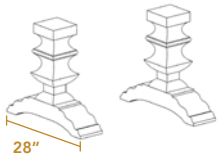

BRTB
Bartlett, 28"w

Base not available in anything other than 30" height

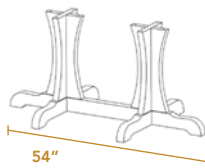

BTDTB
Bridgeport Double, 54"w

Butterfly style leaf not available

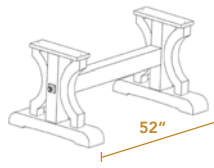

CPTB
Caspian, 52"w

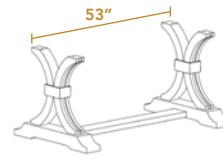

FETB
Farmville, 53"w

Base not available in anything other than 30" height

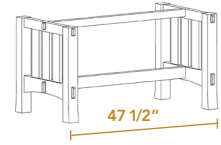

GNTB
Goshen, 47 1/2"w

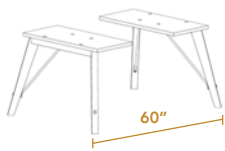

HYTB
Harmony Trestle, 60"w

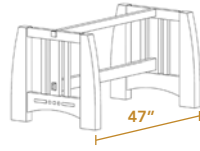

HHTB
Hayworth, 47"w



METB
Melbourne, 25 1/2"w

72" Table Length, 48" Base OAL Length
84" Table Length, 60" Base OAL Length
96" Table Length, 72" Base OAL Length
108" Table Length, 84" Base OAL Length
120" Table Length, 96" Base OAL Length
144" Table Length, 108" Base OAL Length



MITB
Mila, 27 1/2"w

60" Table Length, 37.5" Base OAL Length
66" Table Length, 43.5" Base OAL Length
72" Table Length, 49.5" Base OAL Length
84" Table Length, 61.5" Base OAL Length
96" Table Length, 73.5" Base OAL Length

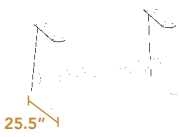

MSTB
Muse Trestle, 25 1/2"w

60" Table Length, 36" Base OAL Length
66" Table Length, 42" Base OAL Length
72" Table Length, 42" Base OAL Length
84" Table Length, 54" Base OAL Length
96" Table Length, 66" Base OAL Length

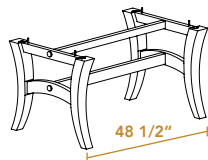

SNTB
Sheridan, 36 1/2"w or 48 1/2"w

Base not available in anything other than 30" height

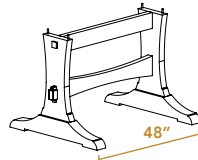

WATB
Wasilla, 36"w or 48"w

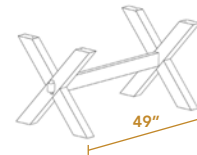

XRTB
Xander, 49"w

BASE OPTIONS

Bases are available in 36" counter height or 42" bar height as listed. Maximum extended size with leaves installed for these heights is 66" in length.

Double pedestal trestle table bases with a starting top size smaller than 72" will receive a 32" stretcher in order to accommodate chair placement at the ends of the table.

CHARACTERISTICS OF SPECIAL TABLE TOPS

Plank Top

A plank-style top is created by randomly joining boards with bread-boarded ends and in varying widths from 2 to 13 inches. Depth of offset from board to board as much as $\frac{3}{8}$ " as well as the number of visible saw cuts will also vary from top to top. Due to the individual uniqueness of each plank top, widths, depth of offsets and saw mark patterns or locations cannot be specified when ordering.

Humidity will affect these types of tops more than a standard top with no breadboards. The breadboards and the boards on the table are moving opposite ways since the grain direction is not the same. This causes shifting of up to $\frac{3}{4}$ ", gapping and the tongue and groove area to sometimes be exposed. Correcting the humidity level in the room will help minimize shifting and gapping, but none of the inconsistencies found in plank-style tops or any top with bread-boarded ends are considered defects. They should, instead, be embraced as unique characteristics of each piece of furniture handcrafted in this manner.

Plank tops not available in Rustic Hickory or Hickory wood.



Showing an **exposed groove** in breadboard



Showing an **exposed board** at breadboard joint

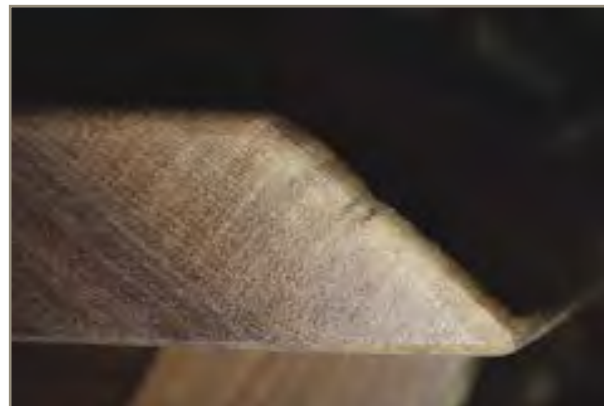

Example of edge with greater angle



Example of edge with little angle

Live-Edge Glue-Up Top

Live-edge glue-up tops are $1\frac{3}{8}$ " thick with live edge pieces on each side and random staves glued in between to achieve the required width. Width is still approximate because of the variation of shapes of the edges. Width can vary by as much as 14" due to the random shapes of the trees from which these pieces are cut. The angle of the edge is determined by where within the log the board was extracted. A table edge without an angle would have been cut from the center of the log. If it has a sharper angle, it means the board was taken close to the outside of the log. One advantage that a glue-up top has compared to a bookmatch live edge slab is that glue-ups tend to be more stable resulting in less cracking and movement as well as lesser cost because of the thickness.

Example of shape without a lot of variation



SEATING FEATURES & OPTIONS

CHAIRS

CHAIR FEATURES

- Constructed with solid hardwoods
- Glued mortise and tenon joints
- Accurately leveled for stability
- Fabric and leather seats are hand selected for consistency

CHAIR OPTIONS

- Distressed finish (#2D)
- Two-tone finish (#2TN)
- Fabric and leather seats available
- Bar stools are available in 24" or 30" high



Joined using both **screws and glue**



Corner block strengthens corners



Solid wood chair backs and table aprons are steam bent during a process that takes days to complete. Once bent, these solid wood parts will last for many lifetimes.



Protective Stretcher Cover (#PC)

- Black protective stretcher covers are standard on all bar chairs.



SEATING FEATURES & OPTIONS

CHAIR CONSTRUCTION

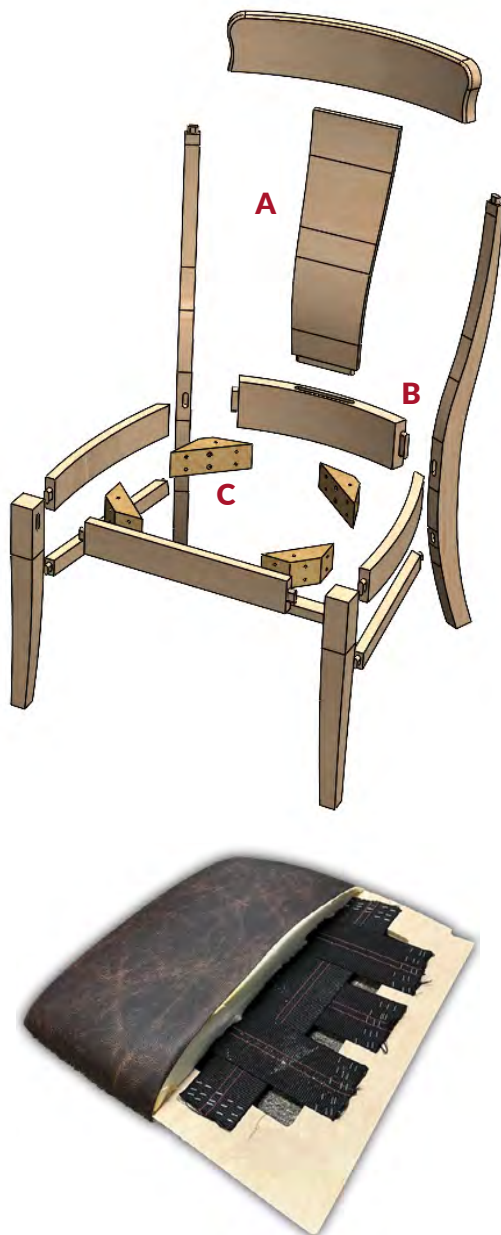

Steam Bent Support (A)

We use high-pressure steam to bend wood into a shape that looks beautiful and provides unparalleled comfort and support.

Mortise & Tenon Joints (B)

A technique that creates a strong and durable frame to withstand everyday use. It also creates a tight and secure fit, making the sturdier and longer-lasting.

Corner Bracing (C)

A framing technique that uses corner blocks to provide additional strength and stability.

Scooped Wood Seats

Designed to contour to the shape of your body, our molded wood seats provide maximum comfort while also helping to maintain proper posture.

Sustainably Sourced Solid Wood

All our chairs are made using responsibly sourced solid wood, giving you the peace of mind that you are making a responsible and sustainable choice.

Superior Comfort with Upholstery

Unlike our competitors, our upholstered seats are built with high quality webbing with a cutout frame that conforms to your body and provides optimal support.

We exclusively use the highest-quality upholstery: stain-resistant, easy to clean performance fabrics as well as durable, long-lasting premium leathers.

scan for more information



UPHOSTERED LIVING ROOM FURNITURE CONSTRUCTION



Unrivaled Seating Support:

Features a #8 Heavy Duty Zig-Zag style spring system for seating to ensure consistent support and resilience for years to come.

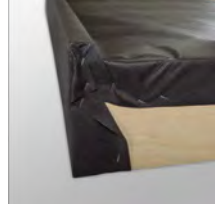

Craftsmanship Beyond Compare:

We've covered the springs with a 1.25oz dust cover and a 3/8" thick insulpad to ensure that your furniture not only looks great but is built to withstand the test of time.



Luxurious Comfort:

The sides of our furniture are covered with Dacron and polyester batting. Sink into the plushness and experience the difference this extra layer of comfort makes.



Fully Upholstered Backs:

We fully upholster the backs of our chairs, sofas, and loveseats to ensure that your furniture looks stunning from every angle.



Premium Materials:

We take pride in offering only the finest materials for our furniture. From performance fabrics to premium leathers, every piece exudes sophistication and luxury.



Unbeatable Cushions:

Our seat cushions boast a 2.8 density with a compression of 35, ensuring a comfortable yet supportive seating experience. Back cushions feature open cell foam with polyester batting, creating a perfect balance of softness and resilience.



Elegance in Style:

Our pillowy box-style seats not only contribute to the exceptional comfort but also make a bold style statement. Fusion Designs' furniture is the epitome of tasteful elegance, making your living room truly stand out.

scan for more information



FABRICS & LEATHERS

FABRICS

One Less Thing to Worry About!

Performance Fabrics are engineered for easy maintenance, comfort, and durability. Performance Fabrics are soft, durable, and stain-resistant. These fabrics are available in a wide array of textures and vibrant colors. Breakthrough protection is woven into every fiber so it won't ever wear away.

Easy Clean:

Performance Fabrics are easy to clean, but are not self-cleaning. Most liquid spills will simply blot off the surface with a dry towel. And for more difficult stains, just follow these simple spot-cleaning instructions:

- Wipe away excess mess using a clean, dry towel
- Mix a simple soap and water solution*
- Apply and agitate with a soft-bristle brush
- Blot with a clean towel
- Rinse thoroughly, repeat if necessary

*We recommend mixing 1 tsp. enzyme laundry detergent, like Tide® or Cheer®, with 2 cups warm water. And remember, soap attracts dirt, so rinse thoroughly.



LEATHERS

Descriptions:

- Premium top-grain glove-soft leather, offers exceptionally soft, silky, hand feel
- Soft silk hand enhanced with the application of a wax touch agent.
- A slightly contrasting crust color is randomly top-sprayed with a translucent solution of highly dispersed micro-pigments to give this leather gentle clouding or smoke effect.
- The natural glow and depth created enhances the sophisticated appearance of this leather.

Thickness:

- 0.9 – 1.0 mm thick

Natural Visibility:

- Some natural marking visible

Finish:

- Top-grain, aniline drum-dyed, micro-pigmented topcoat.
- Moderate protection from application of micro-pigmented topcoat.
- The beauty of aniline drum-dyed leather is the lack of uniformity. The dye does not color all sections of the hide uniformly due to the tissue (or cell) structure.
- The neck may be a bit lighter or darker than the butt; the rib and fat wrinkles may be outlined in a slightly darker cast.

Care & Cleaning:

Vacuum or dust with a soft brush regularly.

For Spots and Spills:

- Gently blot excess liquid with a clean absorbent cloth
- Let air dry naturally

For Butter, Oil, or Grease:

- Absorb excess with a clean, dry cloth
- Leave alone
- Spots should dissipate over a moderate time

Do not apply any shoe polish, ammonia water, oils, or any other chemical solutions.

Recommended: Car and Cleaning kits such as those provided by Leather Master. The natural oils are sealed in for permanent and carefree beauty.



Any fabrics or leathers not in the current book will be treated as COM and must be sent to Fusion.

Upholstery, fabric & leather material, foam have a 1 year warranty.

HARDWARE

Pictures are not accurate assessment of size. See measurements for actual size.



A-1 Satin Nickel 5 1/2"

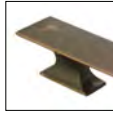

A-2
Oil Rubbed
Bronze

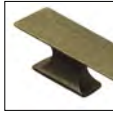

A-3
Windover
Antique



A-25 Knob, Black 7/8"

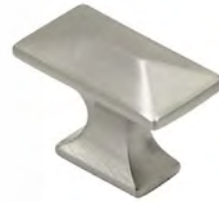

B-2 Satin Nickel 1 3/4"

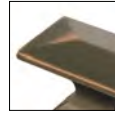

B-3
Oil Rubbed
Bronze



B-4
Windover
Antique



B-25 Bronze 2 1/8"



BH-1
Beacon Hill Handle
Black Iron, 12" Wide



BH-2
Beacon Hill Knob
Black Iron, 1 1/2"



C-3 Antique English 3 3/4"



C-4
Black Iron



D-4 Antique English 1 1/4"



D-5
Black Iron



E-5 Oil Rubbed Bronze 1 1/4"



E-6
Antique
English



E-8
Dark Brushed
Antique
Copper



E-9
Satin Nickel



Satin Nickel
F-6 5 1/2" wide



H-8 Black 3 3/4" x 2"



I-9 Available in
Black or Finished 1 1/4"



J-10 Black Iron 1 1/4"



K-11 Satin Nickel 3 3/4"



K-12
Veneti Bronze



K-Y1 Oil Rubbed Bronze 8"



L-25 Black 8 1/4"



M-1 Gold 1 1/8"



M-2 Gold 5 3/4"



M-13 Black 1" x 3 3/4"



N-14 Available in Black or Finished 1 1/2"



P-16 Bright Nickel Brushed Dull 3 3/4"



Q-17 Bright Nickel Brushed Dull 1 1/4"



R-18 Satin Nickel 4 1/2"
R-2 Satin Nickel 6"



S-19 Antique English 3 1/2" x 1 1/2"



SO-1 Soma Knob
Antique Brass, 3 1/4"



T-25 Black Iron 4 1/2"



Y-2 Oil Rubbed Bronze Dull 4"



U-1 Oil Rubbed Bronze 1 1/4"



U-2 Oil Rubbed Bronze 3 3/4"



V-25 Satin Nickel 6 7/8"



W-1 Black 1 1/4" x 4 1/2"



W-3
Oil Rubbed Bronze



W-4
Antique Copper



W-6
Oil Rubbed Bronze



W-7
Antique Copper



W-2 Black 1 1/4" x 4 1/2"



X-2 Satin Nickel, 5 1/8"



X-1
Oil Rubbed Bronze
Highlighted



Y-1 Oil Rubbed Bronze Dull



Z-4 Satin Nickel, 1 1/4"



Z-3
Brushed Oil
Rubbed Bronze



Z-5
Pewter

BEDROOM FEATURES & OPTIONS



Optional **footrail** instead of footboard is available on most beds.

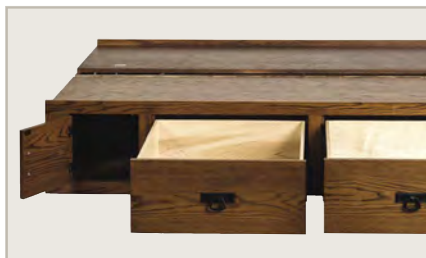

Optional **underbed storage drawers**. Multiple storage rail configurations are available. See line drawings for details.



Dovetail joinery is a time-honored technique that connects each board with interlocking pins and tails.



Optional **LED night light** with touch switch (#LEDN)



Optional **sliding top nightstand** with secret compartment, lock and 3-plug power strip (#STP)



Cast metal brackets firmly hold bed slats in place providing solid support for every mattress size.



Most chest bottom drawers feature a **cedar lined bottom**.



All nightstands feature **USB A&C power port**.



Fusion Designs uses **floating panel construction**. Rubber space balls are inserted into the frame so the wood panels can expand and contract without causing damage. **Soft-close undermount drawer glides** assure quiet operation of solid wood drawers.



2 plug, 2 USB **power port** available in all nightstand top drawers (#DKD). Removable tray keeps drawer organized and can be used as a portable work surface.

Solid wood is used throughout our construction process including case goods and beds however there are times when the design or construction of the item requires us to use some MDF core plywood in order to prevent shrinking or expanding that could be detrimental to the integrity of the piece. There are many different types of plywood cores including veneer core, MDF core and Particle board however all of these are considered plywood which means a veneered piece of wood over a substrate. The reason MDF core is used in a lot of the furniture industry including kitchen cabinets is that it is considered the premier "plywood" to use due to it having a more consistent flat surface. Veneer core can have a "rippling" effect because it is softer in some spots than others making a smooth surface difficult to achieve. Also veneer core plywood will still have a tiny bit of movement where MDF core will not.

CARING FOR YOUR FUSION DESIGNS FURNITURE

Your new furniture is a reflection of your good taste. It combines nature's best materials with our Amish craftsmanship. To assure that your investment becomes a treasured heirloom to withstand the test of time, take the same care in maintaining the beauty of your furniture as you took in selecting it.

“Beautiful!”

PLACEMENT

Carefully consider where your new furniture is located in your home. Avoid setting it directly in front of radiators, heating vents, or wood-burning stoves as dry air can cause wood to dry out and crack.

HUMIDITY

The ideal indoor humidity range for solid wood furniture is 35-45%. An uncontrolled environment causes expansion and contraction which leads to splitting of the grain pattern or joints and gapping where leaves fit into the table. These conditions should be appreciated as inherent characteristics of solid wood and should not be assumed to be a defect in materials or workmanship.

PROTECTION & CLEAN UP

Simply dust furniture often with a soft cloth taking care to follow the grain pattern. Periodically clean with a mild, non-alkaline soap and water using a soft cloth or sponge. Dry immediately with a soft cloth and lightly buff wood grain. Avoid nail polish remover, alcohol, or other solvents. A high-quality furniture polish may be used occasionally, but do not use polishes that contain silicones. Your retailer can recommend a polish or wax.

LEAF STORAGE

Store extra table leaves in or close to table to maintain consistent environmental conditions (not in a damp basement or dry attic). By following these simple tips, you'll get many years of enjoyment from your new furniture and when you are ready to pass it on, the new owner's first word is sure to be, “Beautiful!”



You will need to register with us as the original owner of Fusion Designs furniture. Should the properly maintained furniture fail at any time during the ownership and lifetime of the original owner because of workmanship or materials defect, we will either repair or replace it upon our discretion. This warranty does not apply to damage due to normal use, misuse, neglect or abuse, exposure to extreme heat, cold or humidity or to damage done in transit. Customer is responsible for freight costs to and from the factory. Fusion Designs is not responsible for gapping or seasonal cracking on items after two years of age. One year warranty on all electronics, fabric, leather, foam and upholstery. There is no warranty on custom items.

WOOD SPECIES & FINISHES



RED OAK

Red Oak has a pronounced open grain with an orange/reddish hue with the sapwood being white to light brown. The stain absorbs into this open grain pattern becoming darker where the grain is close and lighter where the grain is more open.

DURABILITY

Very durable with good wear-resistance, with a 1290 rating on the Janka Hardness scale*. The grain pattern can help hide minor dents and wear.



BROWN MAPLE

Brown Maple has a smooth grain pattern and is characterized by the varying brown, tan, white, and cream streaks. It absorbs medium to dark stains well and its smooth surface is ideal for painted finishes.

DURABILITY

It is a softer hardwood so it is more prone to scratches and denting with heavy use. It has a rating of 950 on the Janka Hardness scale*.



1/4 SAWN WHITE OAK

Quarter Sawn White Oak has a unique grain pattern which is achieved by cutting the wood at a 90 degree angle to the tree's growth rings which exhibits a tight grain with cooler white to sage tones, and absorbs stains richly and evenly.

DURABILITY

Very durable with good wear-resistance with a rating of 1360 on the Janka Hardness scale*. The grain pattern can help hide minor dents and wear.



CHERRY

Cherry has a softer, circular grain pattern with minimal knots and pits throughout and slight white, brown, and deep red color variations throughout the wood. Over time the wood will darken with exposure to light and heat.

DURABILITY

Because it is softer hardwood, it is more prone to denting with heavy use. It has a rating of 950 on the Janka Hardness scale*.



RUSTIC CHERRY

Rustic Cherry has a softer, circular grain pattern with knots and pits throughout and contrasting white, brown, and deep red color variations throughout the wood. Over time the wood will darken with exposure to light and heat.

DURABILITY

Because it is a softer hardwood, it is more prone to denting with heavy use. It has a rating of 950 on the Janka Hardness scale*.



RUSTIC HICKORY

Rustic Hickory has a predominant grain pattern with knots and burls and contrasting reddish, cream and dark brown colors.

DURABILITY

It is the strongest wood type that we offer with a rating of 1820 on the Janka Hardness scale*. The grain pattern can help hide minor dents and wear.



RUSTIC WHITE OAK

Compared to red oak, on the average, white oak is heavier, stronger, and frequently darker in color. White oak has much larger (longer and wider) ray cells (1/2 inch long in red and 1-1/2 inches or longer in white), giving white oak a very strong ray fleck pattern.

DURABILITY

White oak wood has many desirable properties, including natural decay resistance, very high strength, and is impervious to liquids and ranks at 1360 on the Janka Hardness Scale and wear.

FINISH COLORS

*Walnut is a 30% upcharge from Cherry cost

*Elm wood is available at quartersawn price Available on table tops, case good tops and chair seats only

#01 Quartersawn White Oak

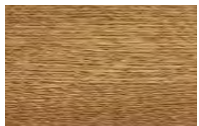

Asbury #30	Michaels #32	Toffee #99	Oatmeal #113	Harbor Gray #115

This cut differs from traditional cutting of oak as it is made parallel to the wood's age rings instead of across. This cut yields a board with amazing strength, much less likely to crack, check or warp than when it is flat sawn. White Oak produces a distinctive "stripping" which gives pieces a more antique look.

***JANKA HARDNESS SCALE**
This number helps determine how well a wood will withstand dents, dings, and wear. The higher the number the more durable the wood is.

#02 Oak



Michaels #32	Medium #33	Toffee #99	Oatmeal #113	Autumn #51	Velvet Dusk #126	Harbor Gray #115

Oak is a heavy, strong, light colored hardwood. Prominent rings and large pores give oak a coarse texture and prominent grain.

#03 Brown Maple



Asbury #30	Michaels #32	Black #44	New Century #45 distressed	White #46	Velvet Dusk #126	Antique Black #59	Chocolate #65	Toffee #99	Eucalyptus #122	Soft Brown #124	Warm Brown #123	Autumn #51

Dew #103	Oatmeal #113	Aged Mineral #114	Harbor Gray #115

*Lighter colors will show more noticeable variation in color due to wood grain

This wood is cut from the center of various soft maple trees and not a specific species of tree. As it's from the center of the tree, it tends to run a range of colors from light to beige to medium brown. It's a smooth wood often finished with paint or darker finishes.

#04 Cherry



Asbury #30	Michaels #32	Autumn #51	Natural #53	Oatmeal #113

A moderately hard, strong, closed grain, light to red-brown wood, cherry tends to resist warping and checking. Cherry is often used in fine furniture and cabinetry and looks great on colors ranging from light to dark. Cherry wood is also known to have small mineral deposits or character marks, these are not considered a defect.

WOOD SPECIES & FINISHES

#06 Rustic Hickory

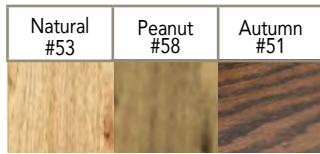
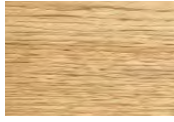

Hickory is one of the heaviest and hardest woods available. It has a close grain without much figure. Hickory wood is often finished in lighter or natural. The rustic refers to the character marks that are noticeable in this cut of wood which can include worm holes, pits, knots, open grain and multiple marks. Knot holes will be filled on tops and chair seats only.

#07 Rustic Cherry

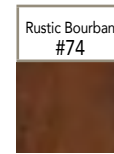
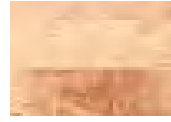

#18 Rustic White Oak

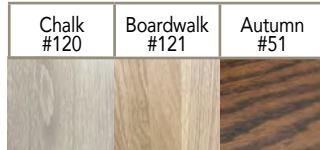

FINISHING OPTIONS

Distressed Option



Distressing can be added to create a worn or aged look to your furniture. Our distressing process is carefully created using hand tools such as handplanes, hammers and nails giving your furniture natural looking worm holes, dents, cracks and natural worn edges.

Painted Color Option

Fusion Designs also has painted colors available to help accent that special piece. Although paints are durable, it is not recommended for use on table tops.

Two Tone



Customize your color combination by going with a two tone finish. Chair seats, table tops and case good tops can be a different color than the rest of the item, making this piece unique!

Any other two tone combination will be charged at a 25% upcharge.

Matte Finish Option

Fusion Designs also offers a matte option that creates a dull, flat finish. This means it will reflect very little light and will lack highlights and gloss.
*No Upcharge

Indicates 15% upcharge

FINISHING STANDARDS

Fusion Designs' modern finishing plant offers a wide variety of finishes including paint alternatives. Conversion varnish is applied to all surfaces to provide the best protection and durability. We use stains, sealers and lacquers with low VOC and HAPS to lessen the impact on the environment.

Fusion Designs uses a "secret" ingredient when mixing their varnish that results in the smooth, warm texture of the finished product. Our dealers have noted that if wearing a blindfold, they could pick out a Fusion Designs item from their floor just by the touch!

Although we try to match the colors shown here as close as possible to the actual woods and finishes, a color sample should be ordered to assure accuracy in colors. Finishes depicted here are paired with the wood & color combinations that are shown on samples. However, all woods shown can be paired with any of the listed colors even if not shown. We also recommend ordering a color sample if choosing a finish/wood combo that is not displayed on a sample.

Superior Stain Resistance

In independent testing with criteria similar to KCMA specifications, the finishes primarily used by Fusion Designs exhibited superior performance in resisting stains.

Chemical	Effect
Water	No Effect
Ethanol (50% in H ₂ O)	No Effect
Coffee (black)	No Effect
Vinegar	No Effect
Lemon juice	No Effect
Orange juice	No Effect
Grape juice	No Effect
Ketchup	No Effect
Olive oil	No Effect
Detergent solution	No Effect
Mustard*	No Effect
Soft drink	No Effect
Whiskey	No Effect
Shoe polish	Slight stain
Ethyl alcohol (100%)	Slight softening
Iodine	Stain

*Mustard test was 1 hour – all others were 24 hours



PAINT



PAINT PROGRAM DISPLAY

We're excited to introduce a new Paint Program Display designed for dealers who want to offer customers an expanded palette of premium paint finishes.

This stand-alone program features a curated set of exclusive paint options that go beyond our standard finish offering. While these paints are not listed in our regular catalog or on existing kiosks, they are available on any Fusion Designs product at no upcharge.

DISPLAY PACKAGE INCLUDES

A branded paint sample display

All curated paint samples

Total cost: \$250



PURE WHITE
SW 7005



ALABASTER
SW 7008



CREAMY
SW 7012



ACCESSIBLE BEIGE
SW 7036



REPOSE GRAY
SW 7015



AGREEABLE GRAY
SW 7029



MINDFUL GRAY
SW 7016



DORIAN GRAY
SW 7017



OYSTER BAY
SW 6206



EVERGREEN FOG
SW 9130



GREEN SPROUT
SW 7728



OLIVE GROVE
SW 7734



NIEBLA AZUL
SW 9137



FRENCH MOIRÉ
SW 9056



NAVAL
SW 6244



GALE FORCE
SW 7605



REDEND POINT
SW 9081



REDDENED EARTH
SW 6053



TOILE RED
SW 0006



CRABBY APPLE
SW 7592



MORRIS ROOM GREY
SW 0037



ANONYMOUS
SW 7046



URBAN BRONZE
SW 7048



TRICORN BLACK
SW 6258

These paint colors are available at no additional charge for any Fusion Designs product.

Please note that we do not recommend painting table tops for durability and aesthetic reasons. The exact appearance of your piece will be influenced by the grain and species of wood. Use these swatches as a guide and ask a finish specialist for an actual sample.



DISPLAYS

The dining room design center and the bar chair display are available for qualifying retailers. Please ask your representative for details.



Fusion Designs Dining Room Display

#1KD

Approximately: 24" w x 24" d x 80" h

The kiosk allows the customer to experiment with various wood stain colors, wood species, along with leg and hardware options. The swivel-leg design allows you to line up your leg choice with optional edge profiles.



Internet Policy

Dear Valued Customer,

It has come to our attention that Fusion Designs tables are being offered for sale on the internet at prices that we consider too low. This has caused a great deal of dissatisfaction among our customers, because of the inability to have a level playing field.

A key component of the success of Fusion Designs has been a quality presentation of our products and a corresponding sales approach that provides the consumer with all of the information necessary to make a truly informed purchase decision. We have always believed that an essential ingredient of our success is the personal interaction between well-trained sales personnel and the retail consumer.

An integral part of ensuring consumer satisfaction is prompt and responsible warranty service. If our tables are sold through the internet to locations remote from that of the actual dealer, the quality of such follow up service usually is inadequate and our image with the consumer could be damaged. It is the dealer's responsibility to take care of such warranty issues.

In light of all the factors stated above, it is our preference that our product is sold in a retail store. However, because of having responsible dealers who sell on the internet at fair prices, we feel we cannot ban internet sales.

Therefore, in order to be fair to everyone, we will require that all online pricing have a new MAP of 120% off of our FINISHED pricelist. This includes sales that you may be running. Failure to comply with this requirement risks termination of dealership.

Here are a few guidelines for advertising our product on the internet: You may not promote "free shipping." Shipping needs to be an added cost, in addition to our required selling price. You should not advertise that you have lower prices because you have no overhead costs. Any reports of an internet company directing customers to a retail store to see furniture, with the intention of buying via the internet because of price, will result in termination of dealership.

We are confident that you will join us in appreciating the long-term benefits of this policy, which is effective immediately.

Sincerely,

Fusion Designs

DINING OPTIONS

Revive the art of conversation by gathering your family and friends for meals in your custom – furnished dining room. Handcrafted furniture by Fusion Designs reflects your personal style, your high quality standards and your great eye for detail. We design our furniture for the way you live.

**YOUR HOME
IS YOUR CANVAS.**

ARABELLA *collection*

COLLECTION FEATURES

- Constructed with solid hardwoods

COLLECTION OPTIONS

- Distressed finish (#2D)
- Two-tone finish (#2TN)

Table Options

- See page 17 for customization and self storing information



60" x 60" x 1 3/8" Round top (6060T138TR) with Arabella single pedestal (ARTB) and a Bevel edge profile (EB)

Arabella 60" Round Pedestal Table

Table-#ARTB 6060T138 TR EB

Table Height: 30 3/8"

Base will accommodate tops in sizes 48" x 48" - 72" x 72". Max top size 72" with leaves installed.

Popular Sizes:

#ARTB4848T138TREB 48" x 48"

#ARTB5454T138TREB 54" x 54"

#ARTB6060T138TREB 60" x 60"

#ARTB7272T138TREB 72" x 72"

12" Table Leaf

36" round tables are not available with BBS slide upgrade



Melbourne Dining Chair

#MESCF- Fabric

Upholstered Seat and Back

18 1/4" w x 17 1/2" d x 34 1/2" h

Not available unfinished



Shown in Brown Maple with #30 Asbury

BARTLETT *collection*

COLLECTION FEATURES

- Constructed with solid hardwoods

Buffet Features

- Soft-closing, full extension, undermount drawer slides
- Soft closing doors
- Dovetailed, solid wood drawers
- Adjustable wood shelves in door
- Wine rack

COLLECTION OPTIONS

Table Options

- See page 17 for customization and self storing information

Buffet Options

- See hardware page in Features & Options section

Bartlett Arm Chair

#BRARW

24"w x 17"d x 38 1/4"h



Bartlett Side Chair

#BRSCW

19 1/4"w x 17"d x 38 1/4"h



Shown in Brown Maple
with # 51 Autumn Finish



*1 shelf per section

Bartlett Buffet (2 Door, 4 Drawer)

#BRBF54

20" w x 54" d x 40" h

Buffet Top: 54" w

Bartlett Buffet (2 Door, 4 Drawer)

#BRBF72

20" w x 72" d x 40" h

Buffet Top: 72" w

Bartlett Buffet (4 Door, 4 Drawer without wine rack)

#BRBF460

20" w x 60" d x 40" h

Buffet Top: 60" w

Bartlett Buffet (2 Door, 4 Drawer)

#BRBF60

20" w x 60" d x 40" h

Buffet Top: 60" w

Bartlett Buffet (4 Door, 4 Drawer without wine rack)

#BRBF454

20" w x 54" d x 40" h

Buffet Top: 54" w

Bartlett Buffet (4 Door, 4 Drawer without wine rack)

#BRBF472

20" w x 72" d x 40" h

Buffet Top: 72" w



Bartlett Table

Table-#BRTB 4272T138 TM EM

Table Height: 30 3/8"

Base will accommodate tops in

sizes 36" x 60" - 72" x 72".

Max top size 120" with

leaves installed.

Popular Sizes:

#BRTB4272T138 42" x 72"

#BRTB4872T138 48" x 72"

12" Table Leaf

42" x 72" x 1 3/8" Mission top (4272T138TM) with
Bartlett Double pedestal (BRTB) and a Mission edge profile (EM)

BENNETT *collection*



Bennett Table

Table-#BTTB
42x42, 48x48, 54x54, 60x60

Max top size 66" with
leaves installed.

Popular Sizes:

#BTTB4242 42"

#BTTB4848 48"

#BTTB5454 54"

#BTTB6060 60"

Available up to 2 leaves. If
table gets leaves, aprons will
be added. Round Under Edge
(Bennett Exclusive).

1.375" Thick Top.

Also available in counter height
and pub height as a solid top
only.



SUGGESTED CHAIR

Kai Side Chair

18"w x 22"d x 35 1/2"h

Fabric Seat #KICF

Leather Seat #KICL

Not available unfinished



Kai Chairs shown in Oak with #100 Pebble with C7-9 Carve Fabric Seat.
Bennett Table shown in Oak with #115 Harbor Gray

BOWIE *collection*

COLLECTION FEATURES

Bowie Features

- Round top is standard
- Underbevel edge is standard
- 1" thick top is standard



SUGGESTED CHAIR

Quinn Side Chair

18" w x 21" D x 31 1/2" h

#QNSCF

Standard with fabric seat/back.

Only available as side chair.

Not available unfinished



Bowie Table

Table-#BETB 4242 TR EU

Max top size 66" with
leaves installed.

Popular Sizes:

#BETB3636 36"

#BETB4242 42"

#BETB4848 48"

#BETB5454 54"

Choice of 12" leaf or
18" butterfly leaf

36" round tables are not
available with BBS slide upgrade

Shown in Brown Maple with #65 Chocolate finish

BOWIE PUB *collection*

COLLECTION FEATURES

Bowie Pub Features

- Available sizes are 36", 42", or 48" Round
- Available only in 36" tall (42" tall not available)
- Underbevel edge is standard
- Pub only available as solid top
- Pub table top will be built without apron

Bowie Pub Table
Table- #BETB 4242 TR EU TLC

Popular Sizes:

#BETB3636TLC 36"

#BETB4242TLC 42"

#BETB4848TLC 48"

36" round tables are not available with BBS slide upgrade



Shown in Oak with #113 Oatmeal with C22-12 Fincher Fabric

BRIDGEPORT *collection*

COLLECTION FEATURES

– Constructed with solid hardwoods

Chair Features

- Bench-built construction
- Glued mortis and tenon joints
- Accurately leveled for stability

COLLECTION OPTIONS

Table Options

- See page 17 for customization and self storing information



42" x 42" x 1" Round top (4242TR) with Bridgeport Single pedestal (BTTB) and a Roundover edge profile (ER)

Bridgeport Table

Table-#BTTB 4242 TR ER

Base will accommodate tops in sizes 36" x 36" - 60" x 60". Max top size 66" with leaves installed.

Popular Sizes:

- #BTTB3636 36"
- #BTTB4242 42"
- #BTTB4848 48"
- #BTTB5454 54"
- #BTTB6060 60"

Choice of 12" leaf or 18" butterfly leaf

36" round tables are not available with BBS slide upgrade

Bridgeport Side Chair

#BTSCW

17"w x 16 1/2"d x 37 1/2"h



Shown in Brown Maple with #32 Michael's Cherry Finish

BRIDGEPORT DOUBLE PEDESTAL

collection

COLLECTION FEATURES

– Constructed with solid hardwoods

COLLECTION OPTIONS

Table Options

– See page 17 for customization and self storing information



Hatfield Side Chair
#HASCW
18 1/2" w x 16 1/2" d x 37 1/2" h



42" x 72" x 1" Banquet top
(4272TBT) with Bridgeport
Double pedestal (BTDTB) and
a Roundover edge profile (ER)

Bridgeport Double Pedestal Table

Table-#BTDTB 4272 TBT ER

Base will accommodate tops in sizes 36" x 60" - 72" x 72". Max top size 120" with leaves installed.

Popular Sizes:

#BTDTB3660 36" x 60" #BTDTB4866 48" x 66"
#BTDTB4266 42" x 66" #BTDTB4872 48" x 72"
#BTDTB4272 42" x 72"

12" Table Leaf



Shown in Brown Maple with #126 Velvet Dusk

CAPE COD PUB *collection*

COLLECTION FEATURES

– Constructed with solid hardwoods

Table Features

– Base features 2 drawer for 30" height tables, 3 drawer for 36" height, and 3 drawer for 42" high

Chair Features

– Standard seat height is 24"

COLLECTION OPTIONS

– Distressed finish (#2D)

– Two-tone finish (#2TN)

Table Options

– See page 17 for customization and self storing information



Shown in Rustic Hickory with #58 Peanut

Cape Cod Bar Chair
#CDBSW
25" w x 18" d x 40" h



48" x 48" x 1" Mission top with 1 butterfly leaf (48481BTM) with 36" tall Cape Cod pedestal (CDTB) and a Mission edge profile (EM)



Cape Cod Table
Table-#CDTB 48481B TM EM

Base will accommodate tops in sizes 48" x 48"-72" x 72". Max top size 72" with leaves installed.

Popular Sizes:
#CDTB4848 48" x 48"
#CDTB4860 48" x 60"

Solid Top or
18" Butterfly Leaf Only

Table is standard with 3 drawers and 36" tall

CASPIAN *collection*

COLLECTION FEATURES

- Constructed with solid hardwoods

Trestle Table Features

- Top features 1 3/8" thick, plank style top

Single Table Features

- 1 3/8" thick smooth top is standard
- Round top is standard
- Mission edge is standard

Hutch Features

- Flush doors with light guard
- Antique glass sides
- Leaded glass doors
- Open deck
- Touch lighting
- 1 adjustable glass shelf w/ plate groove in top
- Fixed shelf in base
- Soft closing undermount drawer guide
- Soft closing doors
- Dovetailed solid wood drawers

COLLECTION OPTIONS

Table Options

- See page 17 for customization and self storing information

Hutch Options

- Hardware options (see Features & Options section)
- Mirror Back (#MB)
- Silverware Drawer insert (#SRD)



Caspian Standard Bench

(not shown)

36" w - #CPBEN36

48" w - #CPBEN48

60" w - #CPBEN60

72" w - #CPBEN72

Caspian Expandable Bench

#CPEXB

48-96" w x 13" d x 18" h

See Features & Options section for expectations and details on plank tops.



Shown in Rustic Cherry with
#74 Rustic Bourbon Distressed



Caspian Arm Chair
#CPACL
24" w x 17" d x 39" h
Not available unfinished



Caspian Side Chair
#CPSCS
19" w x 17" d x 39" h
Not available unfinished



Caspian Single Table
Table-#CPSTBT 1384242 TR EM
Table Height: 30 3/8"
Max top size 72" with leaves installed.
Popular Sizes:
#CPSTBT1384242 42"
#CPSTBT1384848 48"
#CPSTBT1385454 54"
#CPSTBT1386060 60" Solid Top Only
12" Table Leaf
36" round tables are not available with BBS slide upgrade

Shown in Brown Maple
with #30 Asbury Finish

CASPIAN *collection*

CONTINUED...

Caspian Hutch

#CPBFT40 (2-door)
42 1/2" w x 20" d x 46" h

#CPBFT60 (3-door)
60 1/2" w x 20" d x 46" h

#CPBFT80 (4-door)
80 1/2" w x 20" d x 46" h

Caspian Buffet

#CPBFB40 (2-door)
40" w x 20" d x 34" h
Buffet Top: 40" w

#CPBFB60 (3-door)
58" w x 20" d x 34" h
Buffet Top: 58" w

#CPBFB80 (4-door)
78" w x 20" d x 34" h
Buffet Top: 76" w



- *1 fixed shelf in base
- *1 adjustable glass shelf w/ plate groove in top



Caspian Table
iron detail



Caspian Table

Table-#CPTB 4272P1 TM EM
Table Height: 30 3/8"
Base will accommodate tops in sizes
36" x 60" -72" x 72". Max top size 120"
with leaves installed.

Popular Sizes:

#CPTB4272P1 42" x 72"
#CPTB4872P1 48" x 72"

16" Table Leaf

42" x 72" x 1 3/8" Planked mission
top (4272P1TM) with Caspian
Double pedestal (CPTB) and a
Mission edge profile (EM)

CELINA *collection*

COLLECTION FEATURES

- Constructed with solid hardwoods

Buffet Features

- Soft-closing, full extension, undermount drawer slides
- Soft closing doors
- Dovetailed, solid wood drawers
- Radius doors
- 1 shelf per door stationary
- If no wine rack, 1 shelf in center

COLLECTION OPTIONS

Table Options

- See page 17 for customization and self storing information

Buffet Options

- See hardware page in Features & Options section



Celina Side Chair

#CLSCF

19" w x 17" d x 39" h

Not available unfinished



Shown in Quartersawn with #100 Pebble finish

CELINA *collection*

CONTINUED...

Celina Buffet
(4 door, 1 drawer)

#CLBF54
20" d x 54" l x 40" h
Buffet Top: 54" w

Celina Buffet
(4 door, 1 drawer)

#CLBF60
20" D x 60" l x 40" h
Buffet Top: 60" w

Celina Buffet
(4 door, 1 drawer)

#CLBF72
20" d x 72" l x 40" h
Buffet Top: 72" w

*1 shelf per door stationary
*If no wine rack, 1 shelf in center



60" x 60" x 1 3/8" Round top
(6060T138TR) with Celina single
pedestal (CLTB) and a Ogee edge
profile (EO)

Celina Table

Table-#CLTB 6060T138 TR EO

Table Height: 30 3/8"

Base will accommodate tops in sizes 48" x 48" -
72" x 72". Max top size 72" with leaves installed.

Popular Sizes:

#CLTB48T138 48"

#CLTB54T138 54"

#CLTB60T138 60"

#CLTB72T138 72" Solid Top Only

12" Table Leaf

36" round tables are not
available with BBS slide upgrade

CHARLESTON *collection*

COLLECTION FEATURES

- Constructed with solid hardwoods
- 1" thick tops

Sebring Side Chair

Wood #SGSCW

Fabric #SGSCF

Leather #SGSCL

18 1/2" w x 16 1/2" d x 37 1/2" h



CHARLESTON *collection*

CONTINUED...

Charleston Pub Table

Table-#CNTBTLC 4242 TR EM

Base will accommodate tops in sizes 42" x 42" - 60" x 60". Max top size 66" with leaves installed.

36" round tables are not available with BBS slide upgrade

42" x 42" x 1" Round top (4242TR) with Charleston single pedestal counter height (CNTBTLC) and a Mission edge profile (EM)



Charleston Table

Table-#CNTB 4242 TR EM

Base will accommodate tops in sizes 42" x 42" - 60" x 60". Max top size 66" with leaves installed.

Popular Sizes:

#CNTB4242 42"

#CNTB4848 48"

#CNTB5454 54"

#CNTB6060 60"

-Solid Top Only

Choice of 12" leaf or 18" butterfly leaf

36" round tables are not available with BBS slide upgrade

42" x 42" x 1" Round top (4242TR) with Charleston single pedestal (CNTB) and a Mission edge profile (EM)

CLASSIC *collection*

COLLECTION FEATURES

- Constructed with solid hardwoods
- 1" thick tops

Buffet & Hutch Features

- Soft-closing, full extension, undermount drawer guides
- Dovetailed, solid wood drawers
- Recessed touch lighting
- Beveled glass doors are standard
- 1 fixed shelf in base
- 1 glass shelf w/ plate groove in top
- Soft-close doors

COLLECTION OPTIONS

- Distressed finish (#2D)
- Two-tone finish (#2TN)

Table Options

- See page 17 for customization, table top shape, and self storing information

Buffet & Hutch Options

- See hardware page in Features & Options section
- Silverware drawer insert (#SRD)
- Mirror back available
- Available with 2 doors (40" wide), 3 doors (56" wide) or 4 doors (72" wide)

Kennebec Side Chair

#KCSCW
19 1/2" w x 19" d x 42" h

Kennebec Arm Chair

(not shown)
#KCACW
25" w x 19" d x 42" h



"STOCK
ITEMS
READY FOR
IMMEDIATE
SHIPPING"



Shown in Brown Maple with #30 Asbury

CLASSIC *collection*

CONTINUED...



Leg options L to R

(top square leg dimensions):

- #L1 Brookline (2 3/8")
- #L2 Englewood (3")
- #L3 Farmer (3 1/2")
- #L4 Hoosier (3")
- #L7 Mission (3")
- #L8 Regular (3")
- #L9 Round Shaker (3")
- #CCTB Classic Shaker L10 (3")



Classic Table

Table-#CCTB 4266 TM EB

Base will accommodate tops in sizes 36" x 36" - 72" x 72". Max top size 216" with leaves installed.

Popular Sizes:

- | | |
|---------------------|---------------------|
| #CCTB3648 36" x 48" | #CCTB4860 48" x 60" |
| #CCTB3654 36" x 54" | #CCTB4866 48" x 66" |
| #CCTB3660 36" x 60" | #CCTB4872 48" x 72" |
| #CCTB4260 42" x 60" | #CCTB6060 60" x 60" |
| #CCTB4266 42" x 66" | #CCTB7272 72" x 72" |
| #CCTB4272 42" x 72" | |

Choice of 12" leaf or 18" butterfly leaf

42" x 66" x 1" Mission top (4266TM) with Shaker legs (CCTB) and a Bevel edge profile (EB)

*Butterfly leaf only available with Mission shaped top (TM)



Classic Hutch

#CCBFT40 (2-door) 40" w x 20" d x 46" h
 #CCBFT56 (3-door) 56" w x 20" d x 46" h
 #CCBFT72 (4-door) 72" w x 20" d x 46" h

Classic Buffet

#CCBFB40 (2-door) 40" w x 20" d x 34" h, Buffet Top: 38 7/8" w
 #CCBFB56 (3-door) 56" w x 20" d x 34" h, Buffet Top: 56 3/8" w
 #CCBFB72 (4-door) 72" w x 20" d x 34" h, Buffet Top: 72" w

- *1 fixed shelf in base
- *1 glass shelf w/ plate groove in top



Classic Arm Chair

#CCACW
 25 1/2" w x 17 3/4" d x 42" h



Classic Side Chair

#CCSCW
 18" w x 17 3/4" d x 42" h

COPENHAGEN *collection*

COLLECTION FEATURES

- Mission edge is standard
- No optional table shapes or edges available
- Base will be used in combination with Flush skirt as shown

Leaf Storage Cabinet Features

- Available in 60" length – stores 36", 42", or 48" long leaves
- 36" standard height
- Standard depth is 19" and will need to add 6" in depth to store 16" wide leaves
- Cabinets can store up to 10 leaves with skirt
- Standard with two adjustable shelves

SUGGESTED CHAIR

Morgan Side Chair

19 1/4" w x 17" D x 34" h

#MNSCW Wood

#MNSCF Fabric

#MNSCL Leather

Morgan Arm Chair (not shown)

24 1/2" w x 17" d x 34" h

#MNACW Wood

#MNACF Fabric

#MNACL Leather



Copenhagen Table

Table-#CHTB 4266 TM EM

Max top size 120" with leaves installed.

Popular Sizes:

#CHTB4260 42" x 60"

#CHTB4266 42" x 66"

#CHTB4272 42" x 72"

#CHTB4860 48" x 60"

#CHTB4866 48" x 66"

#CHTB4872 48" x 72"

12" Table Leaf



Copenhagen Leaf Storage Cabinet

#CHBF60 60"

60" w x 19" d x 36" h



Shown in Brown Maple with #65 Chocolate finish

EDMONTON *collection*

COLLECTION FEATURES

- Constructed with solid hardwoods
- 1" thick tops

Hutch & Buffet Features

- Soft-closing, full extension, undermount drawer slides
- Dovetailed, solid wood drawers
- Inset doors and drawers are standard
- 2 adjustable glass shelves
- Recessed touch lighting
- Adjustable wood shelf in base
- Soft-close doors

COLLECTION OPTIONS

- Distressed finish (#2D)
- Two-tone finish (#2TN)

Table Options

- See page 17 or customization and self storing information

Hutch & Buffet Options

- See hardware page in Features & Options section
- Silverware drawer insert (#SRD)

Edmonton Side Chair
#ENSCW
18"w x 17"d x 38"h



"STOCK
ITEMS
READY FOR
IMMEDIATE
SHIPPING"



Shown in Brown Maple with #99 Toffee

EDMONTON *collection*

CONTINUED...

Edmonton Corner Hutch
#ENBFT
46" w x 25" d x 53" h

Edmonton Corner Buffet
#ENBFB
46" w x 25" d x 36" h

Standard hardware is E-5



Edmonton Table
Table-#ENTB 4242 TR EM

Base will accommodate tops in sizes 36" x 36" - 60" x 60". Max top size 66" with leaves installed.

Popular Sizes:
#ENTB3636 36"
#ENTB4242 42"
#ENTB4848 48"
#ENTB5454 54"

Choice of 12" leaf or 18" butterfly leaf
36" round tables are not available with BBS slide upgrade

42" x 42" x 1" Round top (4242TR) with Edmonton single pedestal (ENTB) and a Mission edge profile (EM)

ELARA *collection*

COLLECTION FEATURES

- Constructed with solid wood
- 1" Thick Tops

Table Features

- Base will be used in combination with detailed skirt as shown

Buffet & Hutch Features

- Soft-closing, full extension, undermount drawer guides
- Dovetailed, solid wood drawers
- Recessed touch lighting
- Soft-close doors
- Display chest includes 2 adjustable glass shelves
- Door chest includes 2 adjustable shelves
- Shelf chest includes 2 adjustable shelves that can be used as wine bottle holders or regular shelves

COLLECTION OPTIONS

- Distressed finish (#2D)

Table Options

- See page 17 for customization and self storing information

Hutch & Buffet Options

- See hardware page in Features and Options section



Elara Side Chair

#EASCF- Fabric

#EASCL - Leather

18 1/2" w x 16 3/4" d x 38" h

Not available unfinished



Shown in Brown Maple with #103 Dew

ELARA *collection*

CONTINUED...



54" x 36" x 1" w/1-18"
Butterfly Leaf and
Mission top (54361BTM)
with Elara legs Counter
Height (EATBTLC) and an
underbevel edge profile (EU)



Elara Bar Chair

#EA24
18 1/2"w x 16 3/4"d x 44"h
#EA24F - 24" Fabric
#EA24L - 24" Leather

#EA30
18 1/2"w x 16 3/4"d x 50"h
#EA30F - 30" Fabric
#EA30L - 30" Leather
Not available unfinished

Elara Pub Table

Table-#EATBTLC 54361B TM EU

Base will accommodate tops in sizes
36"x36"-72"x72". Max top size 216" with
leaves installed.

Popular Sizes:

#EATB36TLC 54"w x 36"d x 36"h Tall
#EATB42TLC42 54"w x 36"d x 42"h Tall
18" Butterfly Leaf



Elara Dining Table

Table-#EATB 4284 TM EU

Base will accommodate tops in sizes 36"x36"-
72"x72". Max top size 216" with leaves installed.

Popular Sizes:

#EATB3648 36"x48" #EATB4284 42"x84" Solid Top Only
#EATB3654 36"x54" #EATB4860 48"x60"
#EATB3660 36"x60" #EATB4866 48"x66"
#EATB4260 42"x60" #EATB4872 48"x72"
#EATB4266 42"x66" Choice of 12" leaf or 18" butterfly leaf
#EATB4272 42"x72"

42" x 84" x 1" Mission top
(4284TM) with Elara legs
(EATB) and an underbevel
edge profile (EU)



Elara Display Chest
#EADPC
40" w x 19" d x 78" h

For same hardware in
brushed nickel color,
specify 7975384195
Hardware choice.

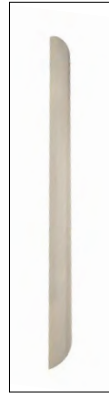

Elara Shelf Chest
#EASC
38" w x 18" d x 38" h



Elara Door Chest
#EADC
38" w x 18" d x 38" h



Shelves can be reversed
for wine bottle storage



Individual units can be combined to form 1 large buffet

FARMVILLE *collection*

COLLECTION FEATURES

- Constructed with solid wood

Trestle Features

- Mission top
- 1³/₈" thick top
- Mission edge profile

Single Pedestal Features

- Mission edge profile
- 1³/₈" thick top
- Minimum top size 42"
- Round top
- Max. length 66" with leaves included

Buffet Features

- Soft-Closing, full extension, undermount drawer slides
- Soft closing doors on buffet only
- Dovetailed, solid wood drawers
- 2 shelves per section in base
- Recessed touch lighting
- 2 glass adjustable shelves in top

COLLECTION OPTIONS

Table Options

- See page 17 for customization and self storing information

Buffet Options

- See hardware page in Features & Options section

Conner Side Chair

19"w x 17"d x 41"h
#CRSCW Wood
#CRSCF Fabric
#CRSCL Leather

Conner Arm Chair (not shown)

25"w x 17"d x 41"h
#CRACW Wood
#CRACF Fabric
#CRACL Leather



Shown in Rustic Cherry with #103 Dew

FARMVILLE *collection*

CONTINUED...

*2 shelves per section in base
*2 shelves in top



Farmville Hutch (2 Door)
#FEBFT
20"w x 60 1/2"d x 46 1/2"h

Farmville Hutch (1 Door)
#FEBFT35
20"w x 57"d x 35"h



Farmville Buffet (3 Drawer, 2 Door)
#FEBF
20"w x 57"d x 35"h

Farmville Buffet (1 Drawer, 2 Door)
#FEBF31
20"w x 31 1/2"d x 35"h



Farmville Single Table
Table-#FETBSP48T138 TR EM
Table Height: 30 3/8"
Max top size 72" with leaves installed.

Popular Sizes:
#FETBSP42T138 42"
#FETBSP48T138 48"
#FETBSP54T138 54"
#FETBSP60T138 60" Solid Top Only

12" Table Leaf

Shown in Brown Maple with #45 New Century finish

36" round tables are not available with BBS slide upgrade



42" x 72" x 1 3/8" Mission top (4272T138TM) with Farmville Double pedestal (FETB) and a Mission edge profile (EM)

Farmville Table
Table- #FETB 4272T138 TM EM
Table Height: 30 3/8"
Base will accommodate tops in sizes 36"x60"-72"x72". Max top size 120" with leaves installed.

Popular Sizes:
#FETB4272T138 42"x72"
#FETB4284T138 42"x84" Solid Top Only
#FETB4872T138 48"x72"
#FETB4884T138 48"x84" Solid Top Only
12" Table Leaf

GOSHEN *collection*



42" x 72" x 1" Mission top
(4272TM) with Goshen
Double pedestal (GNTB) and
a Mission edge profile (EM)

Goshen Table

Table-#GNTB 4272 TM EM

Base will accommodate tops in sizes 36" x 60" -
72" x 72". Max top size 120" with leaves installed.

Popular Sizes:

#GNTB3654 36" x 54"

#GNTB3660 36" x 60"

#GNTB4272 42" x 72"

#GNTB4872 48" x 72"

12" Table Leaf



Goshen Buffet

#GNBF60

60" w x 20" d x 40" h

*1 adjustable wood shelf

GOSHEN *collection*

CONTINUED...

COLLECTION FEATURES

- Constructed with solid hardwoods
- 1" thick tops

Buffet Features

- Textured glass is standard
- One adjustable shelf in each door
- Inset doors and drawers are standard
- Soft-closing, full extension, undermount drawer slides
- Dovetailed, solid wood drawers
- Soft-close doors



Classic Side Chair

#CCSCW

18" w x 17 3/4" d x 42" h

Classic Arm Chair

(not shown)

#CCACW

25 1/2" w x 17 3/4" d x 42" h



Shown in Quartersawn Oak with #12 Michael's Cherry

HARMONY TRESTLE

collection

COLLECTION FEATURES

TABLE FEATURES

- Underbevel edge
- Mission shaped top
- 1" thick solid wood top
- Self storing leaves

-42" x 72" x 1" Mission top (4272TM) with Harmony Trestle (HYTB) and an underbevel edge profile (EU)



Harmony Trestle

#HYTB4272TMEU

Base will accommodate tops in sizes 42" x 72" - 48" x 72". Max top size 120" with leaves installed.

Popular Sizes:

#HYTB4872 48" x 72"

#HYTB4272 42" x 72"

12" Table Leaf



Harmony 66" Bench

#HYBEN6603

66" w x 15 7/8" d x 18 3/8" h



Morgan Chair
#MNSCW
19 1/4" w x 17" d x 34" h



Morgan Arm Chair
#MNACW
24 1/2" w x 17" d x 34" h



HARMONY LEG

collection



42" x 66" x 1" Banquet top
(4266TBT) with Harmony legs
(HYL) and an Underbevel edge
profile (EU)

Harmony Leg Table
#HYLTB4266 TBTEU
42" x 66-88"

Popular Sizes:

#HYLTB3654 36" x 54"
#HYLTB3660 36" x 60"
#HYLTB4260 42" x 60"
#HYLTB4266 42" x 66"

#HYLTB4272 42" x 72"
#HYLTB4860 48" x 60"
#HYLTB4866 48" x 66"
#HYLTB4872 48" x 72"



Harlow Arm Chair
#HWACW
22 1/2" w x 19 1/4" d x 36" h



Harlow Side Chair
#HWSCW
17 3/4" w x 19 1/4" d x 36" h



Shown in Brown Maple with #115 Harbor Gray

HATFIELD *collection*

COLLECTION FEATURES

– Solid wood construction

Chair Features

- Bench built construction
- Glued mortis and tenon joints
- Accurately leveled for stability
- Leather and fabric are hand selected for consistency

COLLECTION OPTIONS

Table Options

- See page 17 for customization and self storing information

Hatfield Side Chair

#HASCW

18 1/2" w x 16 1/2" d x 37 1/2" h

- Also available with fabric or leather seat



Hatfield Table

Table-#L1 4266 TBS EB

Base will accommodate tops in sizes 36" x 36" - 72" x 72". Max top size 216" with leaves installed.

Popular Sizes:

#L1TB3654 36" x 54"

#L1TB3660 36" x 60"

#L1TB4260 42" x 60"

#L1TB4266 42" x 66"

12" Table Leaf

#L1TB4272 42" x 72"

#L1TB4860 48" x 60"

#L1TB4866 48" x 66"

#L1TB4872 48" x 72"

42" x 66" x 1" Boat top (4266TBS) with Brookline legs (L1) and a Bevel edge profile (EB)



Shown in Brown Maple with #32 Michael's Cherry



Features **Ebony Inlays**

- Hayworth Hutch**
 #HHBFT62 (3-door)
 62" w x 21 1/2" d x 46" h
 #HHBFT46 (2-door)
 47" w x 21 1/2" d x 46" h
 #HHBFT80 (4-door)
 80" w x 21 1/2" d x 46" h
 - Crown molding adds
 3" to overall width



*1 shelf in base and
 1 shelf in top



- Hayworth Buffet**
 #HHBFB46 (2-door)
 43 1/2" w x 21 1/2" d x 35" h
 #HHBFB62 (3-door)
 61 1/2" w x 21 1/2" d x 35" h
 #HHBFB80 (4-door)
 76 1/2" w x 21 1/2" d x 35" h



42" x 72" x 1" Boat top (4272TBS) with Hayworth Double pedestal (HHTB) and a Bevel edge profile (EB) with inlay (HI)

Inlay in top and base is standard.

Hayworth Table
 Table-#HHTB 4272 TBS EBHI

Base will accommodate tops in sizes 36" x 60" - 72" x 72". Max top size 120" with leaves installed.

Popular Sizes:
 #HHTB4272HI 42"x72" With Inlay In Top
 #HHTB4872HI 48"x72" With Inlay In Top
 12" Table Leaf

HAYWORTH *collection*

COLLECTION FEATURES

- Constructed with solid hardwoods
- 1" thick tops
- Ebony inlays

Table Features

- Inlay in top and base standard

Hutch & Buffet Features

- Recessed touch lighting
- Beveled glass doors are standard
- 1 shelf in base and 1 shelf in top
- Soft-closing, full extension, undermount drawer slides
- Dovetailed, solid wood drawers
- Soft-close doors



**Hayworth High Back
Arm Chair** (shown)
#HHHACW
26" w x 18" d x 49" h

Hayworth Arm Chair
#HHACW
26" w x 18" d x 43" h



**Hayworth
Side Chair** (shown)
#HHSCW
19" w x 18" d x 43" h

**Hayworth High Back
Side Chair**
#HHHSCW
19" w x 18" d x 49" h



Shown in Quartersawn Oak with #30 Asbury

Ellington Side Chair
18 1/2" w x 17" d x 41" h
Wood #ELSCW
Fabric #ELSCF
Leather #ELSCL

Ellington Arm Chair
26 1/2" w x 17" d x 41" h
Wood #ELACW
Fabric #ELACF
Leather #ELACL



Goshen Buffet
#GNBF60
60" w x 20" d x 40" h
*1 adjustable wood shelf

HEARTLAND *collection*

COLLECTION FEATURES

- Constructed with solid hardwoods
- 1" thick tops
- Mission edge is standard

Buffet Features

- Textured glass is standard
- One adjustable shelf in each door
- Inset doors and drawers are standard
- Soft-closing, full extension, undermount drawer slides
- Dovetailed, solid wood drawers
- Soft-close doors

**Not available with BBS slides due to base style*

54" x 54" x 1" Round top (5454TR) with Heartland single pedestal (HDTB) and a Mission edge profile (EM)



Heartland Table

Table-#HDTB 5454 TR EM

Base will accommodate tops in sizes 48"x48"-72"x72". Max top size 192" with leaves installed.

Popular Sizes:

#HDTB4848 48"

#HDTB5454 54"

Standard with 16" leaves



Table splits in center to accommodate up to 192" in length

HENNING *collection*

COLLECTION FEATURES

- Constructed with solid wood
- Egg Shaped

COLLECTION OPTIONS

Table Options

- See page 17 for customization and self storing information

Henning Side Chair
#HGSCW
18 1/2"w x 17 1/2"d x 32"h



Shown in Brown Maple with #65 Chocolate Finish



Henning Bench
 #HGBEN54
 16" w x 54" d x 18" h



Henning Table
 Table-#HGTB 4254 TE EM

Base will accommodate tops in sizes 42" x 42" – 60" x 60". Max top size 66" with leaves installed.

Popular Sizes:

- #HGTB4254 42" x 54"
- #HGTB4854 48" x 60"
- Solid Top Only

12" Table Leaf

36" round tables are not available with BBS slide upgrade

42" x 54" x 1" Egg/Oval shaped top (4254TE) with Henning single pedestal (HGTB) and a Mission edge profile (EM)

*42" x 54" and 48" x 60" sizes will be standard with square apron as pictured – This table standard with 16" leaves table tops will receive round apron
 Oval table tops will receive oval apron, in order to accommodate slides

INFINITY *collection*

COLLECTION FEATURES

- Constructed with solid hardwoods
- 1" thick tops

Infinity Table

Table-#IYTB 4242 TR EO

Base will accommodate tops in sizes 36"x36"-60"x60". Max top size 66" with leaves installed.

Popular Sizes:

#IYTB4242 42"

#IYTB4848 48"

#IYTB5454 54"

Choice of 12" leaf or 18" butterfly leaf

36" round tables are not available with BBS slide upgrade

42" x 42" x 1" Round top (4242TR) with Infinity single pedestal (IYTB) and an Ogee edge profile (EO)



Madrid Side Chair

#MDSCF- Fabric

#MDSCL- Leather



Shown in Brown Maple with #126 Velvet Dusk

MADRID & MADRID PUB *collection*

COLLECTION FEATURES

Table Features

- Available in 38", 44", or 50" Round
- Round top is standard with flush 2" skirt
- Mission edge is standard
- Standard top thickness is 1"
- No custom sizes or shapes due to flush skirt

Pub Features

- Available in 42" and 48" round solid top
- Standard with round top without skirt
- Underbevel edge is standard
- Standard top thickness is 1"
- Standard height is 36"
- 42" high is not available

View of Madrid
Bar Stool Back



Madrid Side Chair

- #MDSCF- Fabric
- #MDSCL- Leather



Madrid Bar Stool

- #MDSCF- Fabric
- #MDSCL- Leather



Shown in Brown Maple with #30 Asbury finish

MADRID & MADRID PUB

collection

CONTINUED...



Madrid Table
#MDTBM 44 TR EM

Max top size 66" with
leaves installed.

Popular Sizes:
#MDTBM38 38"
#MDTBM44 44"
#MDTBM50 50"

12" Table Leafs
38" round tables are not
available with BBS slide upgrade

Madrid Pub Table
#MDTBM 42TLC TR EM

Solid Top Only

Popular Sizes:
#MDTBM42TLC 42"
#MDTBM48TLC 48"



MARIA *collection*

COLLECTION FEATURES

- Solid wood construction
- Chamfer edge
- Features 1-16' leaf
- Round top is standard
- 1" thick top is standard



Harmony Arm Chair

#HYACW

22 1/2" w x 19 1/4" d x 36" h



Harmony Side Chair

#HYSCW

17 3/4" w x 19 1/4" d x 36" h



Maria Round Table

Table-#MATB4242TREC

Base will accommodate tops in sizes 36"x36" - 60"x60". Max top size 66" with leaves installed.

Popular Sizes:

MATB3636 36"

MATB4242 42"

MATB4848 48"

MATB5454 54"

Choice of 12" leaf or 18" butterfly leaf

36" round tables are not

available with BBS slide upgrade



Shown in Brown Maple with #113 Oatmeal

MELBOURNE *collection*

COLLECTION FEATURES

- Mission Shaped Top
- Mission Edge Profile
- Solid Top Only, grain lengthwise
- Solid hardwoods

Melbourne Single Pedestal Table

#MESTB4848 - 48" Round
#MESTB5454 - 54" Round
*MESTB6060 - 60" Round

Available as a solid top or with leaves
Solid tops standard without aprons
Split tops standard with aprons
Roundunder Edge Standard
Round top shape standard
1 3/8" Standard Top Thickness
OAL Height is 30"



Melbourne Table

Table-#METB4296TMEM

Available Sizes :
36" X-72,84,96,108,120,144
42" X-72,84,96,108,120,144
48" X 72,84,96,108,120,144

Mission Shaped Top
Mission Edge Profile
Solid Top Only, grain lengthwise
Solid hardwoods



Melbourne Dining Chair

#MESCF- Fabric
Upholstered Seat and Back
18 1/4" w x 17 1/2" d x 34 1/2" h
Not available unfinished





Melbourne Buffet

#MEBF

68" w x 18" d x 36" h

Two adjustable wood shelves

Soft-closing doors

No hardware options on buffet



Melbourne Curio

#MECO

40" w x 18" d x 78.5" h

Three adjustable glass shelves

Touch lighting

Soft-closing doors

No hardware options on hutch



Shown in Rustic White Oak with #121 Boardwalk

MILA *collection*



Mila Table
Table-#MATB

Available Sizes :
Width Options: 36, 42, 48
Length Options: 60, 66, 72, 84, 96

Solid Top Only. Oval Top.
Under-chamfer edge (Mila Exclusive).
1.375 Thick Top.

Amara Side Chair
#AMSCF- Fabric
18" w x 21" d x 35 1/2" h
Upholstered Seat and Back
Only available as side chair
Not available unfinished



Santiago Curio
#SGCO
Cabinets: 18.5" d x 36" w x 86" h
1 Adjustable Glass Shelf w/ LED
Lights
1 Adjustable Wood Shelf

Santiago Wine Cabinet
#SCWE
1 Adjustable Wood Shelf
Wine Rack & Stemware Holder



Shown in Rustic White Oak with #120 Chalk with C22-12 Fincher Fabric on chairs

MUSE *collection*



Muse Table

Table-#MSTB

Available Sizes :

Width Options: 36, 42, 48, 54

Length Options: 60, 66, 72, 84, 96

Available as a solid top only

Live edge profile standard

Live edge top shape standard

1.375 standard top thickness

OAL height is 30"

Muse Side Chair

#MSSCW - Wood

#MSSCF - Fabric

#MSSCL - Leather

20"w x 25"d x 38"h

Upholstered Seat and Back

Only available as side chair

Not available unfinished





OLD MISSION *collection*

COLLECTION FEATURES

- Round top is standard
- 1" thick top is standard
- Mission edge is standard

Livonia Desk Chair

25" w x 20" d x 37" h

- Fabric #LVACF
- Leather #LVACL

- Only available on arm chairs
- All desk chair options will have the pictured base as standard.
- No additional options available.

Not available unfinished



Shown in Oak with #32 Michaels

OLD MISSION *collection*

CONTINUED...

Butterfly Leaf shown below



42" x 42" x 1" Round top (4242TR) with Old Mission single pedestal (OMTB) and a Mission edge profile (EM)

Old Mission Table

Table-#OMTB 42421B TR EM

Base will accommodate tops in sizes 36" x 36" - 72" x 72". Max top size 72" with leaves installed.

Popular Sizes:

#OMTB4242 42"

#OMTB4848 48"

#OMTB5454 54"

#OMTB6060 60"

Choice of 12" leaf or 18" butterfly leaf

36" round tables are not available with BBS slide upgrade

REBECCA *collection*

COLLECTION FEATURES

- Solid wood construction
- Chamfer edge is standard
- Round Shaped Top is standard
- 1" top is standard



Harper Arm Chair

#HPACW

22 1/2" w x 19 1/4" d x 36" h



Harper Side Chair

#HPSCW

17 3/4" w x 19 1/4" d x 36" h



Rebecca Round Table

Table #RATB4242TREC
42RD

Base will accommodate tops in sizes 36" x 36" - 60" x 60". Max top size 66" with leaves installed.

Popular Sizes:

#RATB3636 36"
#RATB4242 42"
#RATB4848 48"
#RATB5454 54"

Choice of 12" leaf or 18" butterfly leaf
36" round tables are not available with BBS slide upgrade



Shown in Brown Maple with #113 Oatmeal

SALEM *collection*

COLLECTION FEATURES

- Round top is standard
- Mission edge is standard
- 1 3/8" smooth top is standard



SUGGESTED CHAIR

Richfield Side Chair

NC-9036SCW

19 1/2" w x 17 1/2" d x 41" h

Richfield Arm Chair

(not shown)

NC-9036ACW

26" w x 17 1/2" d x 41" h



Salem Table

#SLTBT 13842 TR EM

Table Height: 30 3/8"

Max top size 72" with leaves installed.

Popular Sizes:

#SLTBT13842 42"

#SLTBT13848 48"

#SLTBT13854 54"

#SLTBT13860 60"

12" Table Leaf

Shown in Brown Maple with
#30 Asbury finish.

36" round tables are not
available with BBS slide upgrade

SHERIDON *collection*

COLLECTION FEATURES

– Bevel edge standard

Conner Side Chair

19" w x 17" d x 41" h

#CRSCW Wood

#CRSCF Fabric

#CRSCL Leather

Conner Arm Chair

(not shown)

25" w x 17" d c 41" h

#CRACW Wood

#CRACF Fabric

#CRACL Leather



Sheridon Table

#SNTB 4272 TM EB

Max top size 120" with leaves installed.

Popular Sizes:

#SNTB4260 42" x 60"

#SNTB4266 42" x 66"

#SNTB4272 42" x 72"

#SNTB4872 48" x 72"

12" Table Leaf

Shown in Cherry wood with #53 Natural finish.



SIMPLICITY *collection*

COLLECTION FEATURES

- Soft close slides
- Natural poplar drawer box with English Dovetail
- All wood species include Walnut accents

**Simplicity Side Chair
(with Inlays)**
#51-9065SCW

**Simplicity Side Chair
(without Inlays, not shown)**
#51-9065SCWNI

**Simplicity Arm Chair
(with Inlays, not shown)**
#51-9065ACW

**Simplicity Arm Chair
(without Inlays, not shown)**
#51-9065AWNI

Drawing from the streamlined looks and clean lines of mid-century modern design and the pared-down aesthetic of Scandinavian spaces, the Simplicity Collection is a contemporary interpretation of Shaker style re-imagined for today's more modern tastes. Smaller-scaled with an emphasis on flexibility, the collection is marked by angular posts and pilasters and functional open shelving that offers the fresh and airy feeling indicative of these serene, light-filled styles. Finished in a mellow Brown Maple stain coupled with tapered walnut bases, legs and contrasting walnut accents, these multi-functional dining room pieces easily move from one room to another depending on decorating needs.



Shown in Brown Maple with #99 Toffee

SIMPLICITY *collection*

CONTINUED...



**Simplicity
Solid Top Bench**
#51-36BEN

Popular Sizes:
#51-36BEN 36"
#51-48BEN 48"
#51-60BEN 60"
#51-72BEN 72"

**Simplicity
Expandable Bench**
#51-1401EXB



Simplicity Trestle
#51-8003 4272 TM EM

Max top size 120" with
leaves installed.

Popular Sizes:
#51-80034272 42"x 72"
#51-80034872 48"x 72"

12" Table Leaf

Top features **Bowtie Inlays**
in each corner and center.

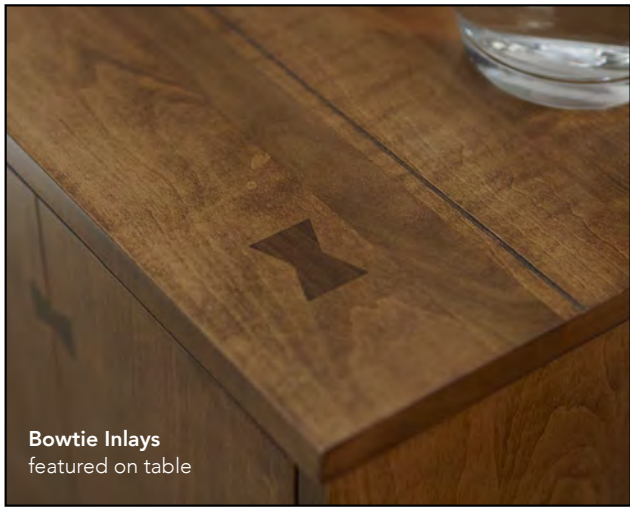

Bowtie Inlays
featured on table



Simplicity Curio Cabinet
#51-1001
38" w x 15" d x 60" h
– Features Walnut base



Simplicity Server
#51-1101
56" w x 19" d x 36" h
– Features Walnut base

THEO *collection*



Theo Table
Table-#TOTB

Popular Sizes:

- #TOTB3030 30"
- #TOTB4242 42"
- #TOTB4848 48"
- #TOTB5454 54"

If table gets leaves, aprons will be added. Inverted Edge. 1" Thick Top. Available in Counter Height (36) and Pub Height (42) ST Only.



Quinn Side Chair

#QNSCF

18" w x 21" d x 32 1/2"

Standard with fabric seat/back.

Only available as side chair.

Not available unfinished



Oak with #113 Oatmeal.
C22-12 Fincher Fabric on Quinn Side Chairs

WASILLA *collection*

COLLECTION FEATURES

– Mission edge standard

Kendall Side Chair

19" w x 18 5/8" d x 42" h

#KLSCW Wood

#KLSCF Fabric

#KLSCL Leather

Kendall Arm Chair

25" w x 18 5/8" d x 42" h

#KLACW Wood

#KLACF Fabric

#KLACL Leather



Wasilla Bench

#WABEN36 36"

#WABEN48 48"

#WABEN60 60"

#WABEN72 72"

Wasilla Expandable Bench

#WAEXB



Wasilla Table

#WATB4272TMEM

Max top size 120"
with leaves installed.

#WATB4260 42" x 60"

#WATB4266 42" x 66"

#WATB4272 42" x 72"

#WATB4872 48" x 72"

12" Table Leaf

Shown in Red Oak with
#100 Pebble finish.

WASILLA Live Edge

collection



Baily Side Chair

18" w x 20 1/2" d x 34 1/2" h
-Wood #BYSCW

Fabric, leather and arm
chair not available



Beautiful **live edge**



Wasilla Live Edge Table

#WATB4272LE
Max top size 96"

#WATB4260LE 42" x 60"
#WATB4266LE 42" x 66"
#WATB4272LE 42" x 72"
#WATB4872LE 48" x 72"

42" x 72" x 1 3/8" Live Edge mission shape top
(42726LETM) with Wasilla double pedestal (WATB)
and a live edge profile (LE)

XANDER *Collection*

COLLECTION FEATURES

– Constructed with solid hardwoods



Beautiful **live edge**



Top shown in Brown Maple with #65 Chocolate
Base Shown in Brown Maple with #44 Black

XANDER *collection*

CONTINUED...



Xander Arm Chair
#XRACW
25 3/4" w x 17 1/4" d x 42 1/4" h



Xander Side Chair
#XRSCW
19" w x 17 1/4" d x 42 1/4" h



Xander Table
Table-#XRTB 4296LE TM
Table Height: 30 3/8"
Base will accommodate tops in sizes 36" x 60" - 72" x 72". Max top size 120" with leaves installed.

- Popular Sizes:**
#XRTB4272LE 42" x 72" Solid Top Only
#XRTB4284LE 42" x 84" Solid Top Only
#XRTB4296LE 42" x 96" Solid Top Only
#XRTB4872LE 48" x 72" Solid Top Only
#XRTB4884LE 48" x 84" Solid Top Only
#XRTB4896LE 48" x 96" Solid Top Only



AM2 Table
Table # AM2TB4296LE
Table Height: 30 3/8"

Base will accommodate tops in sizes 36" x 60" - 72" x 72". Max top size 120" with leaves installed.

- Popular Sizes:**
#AM2TB4272LE 42" x 72" Solid Top Only
#AM2TB4284LE 42" x 84" Solid Top Only
#AM2TB4296LE 42" x 96" Solid Top Only
#AM2TB4872LE 48" x 72" Solid Top Only
#AM2TB4884LE 48" x 84" Solid Top Only
#AM2TB4896LE 48" x 96" Solid Top Only

*Black powder coated metal base

42" x 96" x 1 3/8" Live Edge mission shape top (4296LE TM) with AM2 metal base (AM2TB) and a live edge profile

ZIGLAR *collection*

COLLECTION FEATURES

- Available in 42", 48", 54", 60", and 72" diameter
- 72" round solid top available no leaves
- Standard top thickness is 1 3/8"
- Standard edge profile is 3/4" roundover
- Standard shape is round



SUGGESTED CHAIR

Richfield Side Chair

#NC-9036SCW

19 1/2" w x 17 1/2" d x 41" h

SUGGESTED CHAIR

Bartlett Side Chair

19 1/2" w x 17" d x 38 1/4" h

#BRSCW Wood

#BRSCF Fabric

#BR_SCL Leather



*Not available with BBS slides due to base style – only on split pedestal

ZIGLAR *collection*

CONTINUED...



Ziglar Split Pedestal Table

#ZRSTB 4848 T138 TR ER

Table Height: 30 3/8"

Popular Sizes:

#ZRSTBT1384242 42"

Max top size 126" with leaves.

#ZRSTBT1384848 48"

Max top size 192" with leaves.

12" Table Leaf

*No BBS slides available



Ziglar Table

#ZRTB 5454 T138 TR ER

Table Height: 30 3/8"

Max top size 72" with leaves installed.

Popular Sizes:

#ZRTBT1384242 42"

#ZRTBT1384848 48"

#ZRTBT1385454 54"

#ZRTBT1386060 60"

#ZRTBT1387272 72" Solid Top Only

12" Table Leaf

36" round tables are not available with BBS slide upgrade

LAZY SUSAN

COLLECTION FEATURES

- 1" thick solid wood top
- Ball bearing swivel

A rotating tray to place on a table or countertop to help organize your kitchen or dining room.

30" Lazy Susan
#LS30
30" Round

24" Lazy Susan
#LS24
24" Round



Shown in Brown Maple with #30 Asbury finish





SEATING OPTIONS

Have a seat, sit a spell, chat, relax, reminisce. Share stories of the past. Celebrate the present. Dream of a bright future. Seating by Fusion Designs will be there through it all, from generation to generation, providing comfort, durability, and lasting impressions.

**MEMORIES
BUILT TO LAST
AND SHARE.**

CHAIRS



Amara Chair

Side Chair

18" w x 21" d x 35 1/2" h

– Fabric #AMSCF

– Leather #AMSCL

*Not available as a bar chair

*Not available unfinished



Americana Chair

Side Chair

19" w x 17 1/2" d x 38" h

– Wood #AASCW

– Fabric #AASCF

– Leather #AASCL

Arm Chair

25" w x 17 1/2" d x 38" h

– Wood #AAACW

– Fabric #AAACF

– Leather #AAACL



Banks Chair

Side Chair

19 1/2" w x 21" d x 38 3/4" h

– Fabric #BSSCF

– Leather #BSSCL

Arm Chair

27" w x 21" d x 38 3/4" h

– Fabric #BSACF

– Leather #BSACL



Banks Desk Chair

Arm Desk Chair

27" w x 21" d x 38 3/4" h

– Fabric #BSACFCGL

– Leather #BSACLGL



Bailey Chair

Side Chair

18" w x 20 1/2" d x 34 1/2" h

– Wood #BYSCW

Fabric, leather and arm chair not available

*Desk chair not available.

*Not available as a bar chair



Bartlett Chair

Side Chair

19 1/4" w x 17" d x 38 1/4" h

– Wood #BRSCW

– Fabric #BRSCF

– Leather #BRSCL

Arm Chair

24" w x 17" d x 38 1/4" h

– Wood #BRACW

– Fabric #BRACF

– Leather #BRACL

*Not available as a bar chair



Beacon Hill Chair

Side Chair

- 18 1/2" w x 16 1/2" d x 38" h
 – Fabric #BHSCF
 – Leather #BHSCCL

Arm Chair

- 25 1/2" w x 16 1/2" d x 38" h
 – Fabric #BHACF
 – Leather #BHACL

*Not available as a bar chair
 Not available unfinished

Add to item number the following trim options:

- (#F) French Natural
 (#P) Pewter Nickel
 (#Z) Z Finish, standard if not specified



Bridgeport Chair

Side Chair

- 17" w x 16 1/2" d x 37 1/2" h
 – Wood #BTSCW

*Not available in two tone finish
 *Not available as a bar chair



Caspian Chair

Side Chair

- 19" w x 17" d x 39" h
 – Fabric #CPSCF
 – Leather #CPSCCL

Arm Chair

- 24" w x 17" d x 39" h
 – Fabric #CPACF
 – Leather #CPACL

*Not available as a bar chair
 *Not available unfinished



Celina Chair

Side Chair

- 19" w x 17" d x 39" h
 – Fabric #CLSCF
 – Leather #CLSCCL

Arm Chair

- 20" w x 17" d x 39" h
 – Fabric #CLACF
 – Leather #CLACL

*Not available as a bar chair
 *Not available unfinished



Classic Chair

Side Chair

- 18" w x 17 3/4" d x 42" h
 – Wood #CCSCW
 – Fabric #CCSCF
 – Leather #CCSCCL

Arm Chair

- 25 1/2" w x 17 3/4" d x 42" h
 – Wood #CCACW
 – Fabric #CCACF
 – Leather #CCACL



Clyde Chair

Side Chair

- 20 1/2" w x 24 1/2" d x 35" h
 – Fabric #CYSCF
 – Leather #CYSCCL

Arm Chair

- 20 1/2" w x 24 1/2" d x 35" h
 – Fabric #CYACF
 – Leather #CYACL

*Not available as a bar chair

Desk Chair

- 20 1/2" w x 24 1/2" d x 35" h
 *Not available unfinished

CHAIRS



Cohen Chair

Side Chair

19 1/2" w x 21" d x 38 3/4" h
 - Fabric #CNSCF

- Leather #CNSCL

Arm Chair

27" w x 21" d x 38 3/4" h

- Fabric #CNACF

- Leather #CNAFL

*Not available unfinished



"STOCK
ITEMS
READY FOR
IMMEDIATE
SHIPPING"

Conner Chair

Side Chair

19" w x 17" d x 41" h
 - Wood #CRSCW

- Fabric #CRSCF

- Leather #CRSCL

Arm Chair

25" w x 17" d x 41" h

- Wood #CRACW

- Fabric #CRACF

- Leather #CRACL



"STOCK
ITEMS
READY FOR
IMMEDIATE
SHIPPING"

Edmonton Chair

Side Chair

18" w x 17" d x 38" h
 - Wood #ENSCW

Arm Chair

22 1/2" w x 17" d x 38" h

- Wood #ENACW

*Not available in two tone finish

*Not available as a bar chair



Elara Chair

Side Chair

18 1/2" w x 16 3/4" d x 38" h
 - Fabric #EASCF

- Leather #EASCL

*Not available unfinished



Ellington Chair

Side Chair

18 1/2" w x 17" d x 41" h

- Wood #ELSCW

- Fabric #ELSCF

- Leather #ELSCL

Arm Chair

26 1/2" w x 17" d x 41" h

- Wood #ELACW

- Fabric #ELACF

- Leather #ELACL

*Not available as a bar chair



Flora Chair

Side Chair

18 1/2" w x 22" d x 31 3/4" h

- Fabric #FASCF

- Leather #FASCL

- Wood #FASCW

*Not available unfinished

"STOCK
ITEMS
READY FOR
IMMEDIATE
SHIPPING"



Harlow Chair

Side Chair

17 3/4" w x 19 1/4" d x 36" h

- Wood #HWSCW

- Fabric #HWSCF

- Leather #HWSCCL

Arm Chair

22 1/2" w x 19 1/4" d x 36" h

- Wood #HWACW

- Fabric #HWACF

- Leather #HWACL



"STOCK
ITEMS
READY FOR
IMMEDIATE
SHIPPING"

Harmony Chair

Side Chair

17 3/4" w x 19 1/4" d x 36" h

- Wood #HYSCW

- Fabric #HYSCF

- Leather #HYSCL

Arm Chair

22 1/2" w x 19 1/4" d x 36" h

- Wood #HYACW

- Fabric #HYACF

- Leather #HYACL

CHAIRS

"STOCK
ITEMS
READY FOR
IMMEDIATE
SHIPPING"



Harper Chair

Side Chair

7 3/4" w x 19 1/4" d x 36" h
- Wood #HPSCW
- Fabric #HPSCF
- Leather #HPSCL

Arm Chair

22 1/2" w x 19 1/4" d x 36" h
- Wood #HPACW
- Fabric #HPACF
- Leather #HPACL



Hatfield Chair

Side Chair

18 1/2" w x 16 1/2" d x 37 1/2" h
- Wood #HASCW
- Fabric #HASC F
- Leather #HASCL

Arm Chair

25" w x 16 1/2" d x 37 1/2" h
- Wood #HAACW
- Fabric #HAACF
- Leather #HAACL



Hayworth Chair

Side Chair

18" w x 18" d x 43" h
- Wood #HHSCW
- Fabric #HHSCF
- Leather #HHSCL

Arm Chair

26" w x 18" d x 43" h
- Wood #HHACW
- Fabric #HHACF
- Leather #HHACL

*Not available as a bar chair



Hayworth Highback Chair

Side Chair

19" w x 18" d x 49" h
- Wood #HHHSCW
- Fabric #HHHSCF
- Leather #HHHSCL

Arm Chair

26" w x 18" d x 49" h
- Wood #HHHACW
- Fabric #HHHACF
- Leather #HHHACL



Henning Chair

Side Chair

18 1/2" w x 17 1/2" d x 32" h
- Wood #HGSCW
- Fabric #HGSCF
- Leather #HGSC L



Jameson Chair

Side Chair

17" w x 16 3/4" d x 39 1/2" h
- Wood Seat #JNSCW
- Fabric Seat #JNSCF
- Leather Seat #JNSCL



Kai Chair

Side Chair

18" w x 22" d x 35 1/2" h
- Fabric Seat #KICF
- Leather Seat #KICL
*Not available unfinished



"STOCK
ITEMS
READY FOR
IMMEDIATE
SHIPPING"

Kendall Chair

- Side Chair**
19" w x 18 5/8" d x 42" h
– Wood #KLSCW
– Fabric #KLSCF
– Leather #KLACL
- Arm Chair**
25" w x 18 5/8" d x 42" h
– Wood #KLACW
– Fabric #KLACF
– Leather #KLACL



"STOCK
ITEMS
READY FOR
IMMEDIATE
SHIPPING"

Kennebec Chair

- Side Chair**
19 1/2" w x 19" d x 42" h
– Wood #KCSCW
– Fabric #KCSCF
– Leather #KCACL
- Arm Chair**
25" w x 19" d x 42" h
– Wood #KCACW
– Fabric #KCACF
– Leather #KCACL



Livonia Channel Back Desk Chair

- 25" w x 20" d x 37" h
– Fabric #LVACCF
– Leather #LVACL
- All desk chair options will have the pictured base as standard.
No additional options available.
- *Base available as shown only
*Not available unfinished



Livonia Desk Chair

- 25" w x 20" d x 37" h
– Fabric #LVACF
– Leather #LVACL
- All desk chair options will have the pictured base as standard.
No additional options available.
- *Not available unfinished



Madrid Chair

- Side Chair**
19 1/2" w x 18" d x 35" h
– Fabric #MDSCF
– Leather #MDSCL
- *Not available as swivel bar chairs
*Not available as desk chair



Melbourne Chair

- Side Chair**
18 1/4" w x 17 1/2" d x 34 1/2" h
– Fabric #MESCF
– Leather #MESCL
- *Not available as a bar chair
*Not available unfinished



Morgan Chair

- Side Chair**
19 1/4" w x 17" d x 34" h
– Wood #MNSCW
– Fabric #MNSCF
– Leather #MNSCL
- Arm Chair**
24 1/2" w x 17" d x 34" h
– Wood #MNACW
– Fabric #MNACF
– Leather #MNAACL
- *Not available as a bar chair



Muse Chair

- Side Chair**
20" w x 25" d x 38" h
– Wood #MSSCW
– Fabric #MSSCF
– Leather #MSSCL
- *Not available as a bar chair

CHAIRS



Old Mission Chair

- Side Chair**
 18" w x 17" d x 38" h
 – Wood #OMSCW
 – Fabric #OMSCF
 – Leather #OMSCL
- Arm Chair**
 25" w x 18" d x 38" h
 – Wood #OMACW
 – Fabric #OMACF
 – Leather #OMACL



"STOCK
ITEMS
READY FOR
IMMEDIATE
SHIPPING"

Palmer Chair

- Side Chair**
 18 1/2" w x 16 1/2" d x 37 1/2" h
 – Wood #PRSCW
 – Fabric #PRSCF
 – Leather #PRSCL
- Arm Chair**
 25" w x 16 1/2" d x 37 1/2" h
 – Wood #PRACW
 – Fabric #PRACF
 – Leather #PRACL
- *Not available as a bar chair



Quinn Chair

- Side Chair**
 18" w x 21" d x 32 1/2" h
 – Fabric #QNSCF
 – Leather #QNSCL
- *Not available as arm chair
 *Not available unfinished



"STOCK
ITEMS
READY FOR
IMMEDIATE
SHIPPING"

Richfield Chair

- Side Chair**
 19 1/2" w x 17 1/2" d x 41" h
 – Wood #NC-9036SCW
 – Fabric #NC-9036SCF
 – Leather NC-9036SCL
- Arm Chair**
 26" w x 17 1/2" d x 41" h
 – Wood #NC-9036ACW
 – Fabric #NC-9036ACF
 – Leather #NC-9036ACL



"STOCK
ITEMS
READY FOR
IMMEDIATE
SHIPPING"

Sebring Chair

- Side Chair**
 18 1/2" w x 16 1/2" d x 37 1/2" h
 – Wood #SGSCW
 – Fabric #SGSCF
 – Leather #SGSCL
- Arm Chair**
 25" w x 16 1/2" d x 37 1/2" h
 – Wood #SGACW
 – Fabric #SGACF
 – Leather #SGACL

*Not available as a bar chair



Simplicity Chair

- Side Chair (with Inlays)**
 19" w x 17.5" d x 42" h
 – Wood #51-9065SCW
 – Fabric #51-9065SCF
 – Leather #51-9065SCL
- Side Chair (without Inlays)**
 19" w x 17.5" d x 42" h
 – Wood #51-9065SCWNI
 – Fabric #51-9065SCFNI
 – Leather #51-9065SCLNI
- *Not available as a bar chair
 *Arm chair available, see pricelist for details



Xander Chair

- Side Chair**
 19" w x 17 1/4" d x 42 1/4" h
 – Wood #XRSCW
 – Fabric #XRSCF
 – Leather #XRSCCL
- Arm Chair**
 25 3/4" w x 17 1/4" d x 42 1/4" h
 – Wood #XRACW
 – Fabric #XRACF
 – Leather #XRACL
- *Not available as a bar chair

DESK CHAIRS



All desk chair options will have the pictured base as standard except Livonia and Livonia Channel back.

Livonia and Livonia Channel back have the base pictured below.

No additional options available.



BARSTOOLS

Americana Stationary Bar Chair



Available Features Swivel Stationary Wood Seat Upholstered Seat Arm Kickplate

SKU	Seat Type	Arm Chair	Side Chair	Width	Depth	Height	Footrest Height (From Ground)	Backrest Height (From Seat)
LOW COUNTER 24" Seat Height								
AASCW24B	Wood		✓	18	21½	43	6½	19
AASCF24B	Fabric		✓	18	21½	43	6½	19
AASCL24B	Leather		✓	18	21½	43	6½	19
AAACW24B	Wood	✓		24	21½	43	6½	19
AAACF24B	Fabric	✓		24	21½	43	6½	19
AAACL24B	Leather	✓		24	21½	43	6½	19
COUNTER 26" Seat Height								
AASCW26B	Wood		✓	18	21½	45	8½	19
AASCF26B	Fabric		✓	18	21½	45	8½	19
AASCL26B	Leather		✓	18	21½	45	8½	19
AAACW26B	Wood	✓		24	21½	45	8½	19
AAACF26B	Fabric	✓		24	21½	45	8½	19
AAACL26B	Leather	✓		24	21½	45	8½	19
BAR 30" Seat Height								
AASCW30B	Wood		✓	18	21½	49	12½	19
AASCF30B	Fabric		✓	18	21½	49	12½	19
AASCL30B	Leather		✓	18	21½	49	12½	19
AAACW30B	Wood	✓		24	21½	49	12½	19
AAACF30B	Fabric	✓		24	21½	49	12½	19
AAACL30B	Leather	✓		24	21½	49	12½	19



ONLINE CONFIGURATOR

*Not available in two tone finish



BARSTOOLS

Americana Swivel Bar Chair



ONLINE CONFIGURATOR

Available Features Swivel Stationary Wood Seat Upholstered Seat Arm Kickplate

SKU	Seat Type	Arm Chair	Side Chair	Width	Depth	Height	Footrest Height (From Ground)	Backrest Height (From Seat)
LOW COUNTER 24" Seat Height								
AASCW24WB	Wood		✓	18	22¼	42½	6½	19
AASCF24WB	Fabric		✓	18	22¼	42½	6½	19
AASCL24WB	Leather		✓	18	22¼	42½	6½	19
AAACW24WB	Wood	✓		24	22¼	42½	6½	19
AAACF24WB	Fabric	✓		24	22¼	42½	6½	19
AAACL24WB	Leather	✓		24	22¼	42½	6½	19
COUNTER 26" Seat Height								
AASCW26WB	Wood		✓	18	22¼	44½	8½	19
AASCF26WB	Fabric		✓	18	22¼	44½	8½	19
AASCL26WB	Leather		✓	18	22¼	44½	8½	19
AAACW26WB	Wood	✓		24	22¼	44½	8½	19
AAACF26WB	Fabric	✓		24	22¼	44½	8½	19
AAACL26WB	Leather	✓		24	22¼	44½	8½	19
BAR 30" Seat Height								
AASCW30WB	Wood		✓	18	22¼	48½	12½	19
AASCF30WB	Fabric		✓	18	22¼	48½	12½	19
AASCL30WB	Leather		✓	18	22¼	48½	12½	19
AAACW30WB	Wood	✓		24	22¼	48½	12½	19
AAACF30WB	Fabric	✓		24	22¼	48½	12½	19
AAACL30WB	Leather	✓		24	22¼	48½	12½	19

*Not available in two tone finish

Arya Swivel Bar Chair



Available Features Swivel Stationary Wood Seat Upholstered Seat Arm Kickplate

SKU	Seat Type	Arm Chair	Side Chair	Width	Depth	Height	Footrest Height (From Ground)	Backrest Height (From Seat)
LOW COUNTER 24" Seat Height								
AYSCF24WB	Fabric		✓	21½	20	34	6½	10
AYSCL24WB	Leather		✓	21½	20	34	6½	10
COUNTER 26" Seat Height								
AYSCF26WB	Fabric		✓	21½	20	34	8½	10
AYSCL26WB	Leather		✓	21½	20	34	8½	10
BAR 30" Seat Height								
AYSCF30WB	Fabric		✓	21½	20	34	12½	10
AYSCL30WB	Leather		✓	21½	20	34	12½	10

*Not available in two tone finish *Not available unfinished



ONLINE CONFIGURATOR

BARSTOOLS

Banks Stationary Bar Chair

Available Features Swivel Stationary Wood Seat Upholstered Seat Arm Kickplate



ONLINE CONFIGURATOR

SKU	Seat Type	Arm Chair	Side Chair	Width	Depth	Height	Footrest Height (From Ground)	Backrest Height (From Seat)
LOW COUNTER 25½" Seat Height								
BSSCF24B	Fabric		✓	18	20	42	6½	16%
BSSCL24B	Leather		✓	18	20	42	6½	16%
BSACF24B	Fabric	✓		24	20	42	6½	16%
BSACL24B	Leather	✓		24	20	42	6½	16%
COUNTER 27½" Seat Height								
BSSCF26B	Fabric		✓	18	20	42	8½	16%
BSSCL26B	Leather		✓	18	20	42	8½	16%
BSACF26B	Fabric	✓		24	20	42	8½	16%
BSACL26B	Leather	✓		24	20	42	8½	16%
BAR 31½" Seat Height								
BSSCF30B	Fabric		✓	18	20	42	12½	16%
BSSCL30B	Leather		✓	18	20	42	12½	16%
BSACF30B	Fabric	✓		24	20	42	12½	16%
BSACL30B	Leather	✓		24	20	42	12½	16%

*Not available in two tone finish *Not available unfinished

Banks Swivel Bar Chair

Available Features Swivel Stationary Wood Seat Upholstered Seat Arm Kickplate



ONLINE CONFIGURATOR

SKU	Seat Type	Arm Chair	Side Chair	Width	Depth	Height	Footrest Height (From Ground)	Backrest Height (From Seat)
LOW COUNTER 25½" Seat Height								
BSSCF24WB	Fabric		✓	18	20½	41¼	6½	16%
BSSCL24WB	Leather		✓	18	20½	41¼	6½	16%
BSACF24WB	Fabric	✓		24	20½	41¼	6½	16%
BSACL24WB	Leather	✓		24	20½	41¼	6½	16%
COUNTER 27½" Seat Height								
BSSCF26WB	Fabric		✓	18	20½	41¼	8½	16%
BSSCL26WB	Leather		✓	18	20½	41¼	8½	16%
BSACF26WB	Fabric	✓		24	20½	41¼	8½	16%
BSACL26WB	Leather	✓		24	20½	41¼	8½	16%
BAR 31½" Seat Height								
BSSCF30WB	Fabric		✓	18	20½	41¼	12½	16%
BSSCL30WB	Leather		✓	18	20½	41¼	12½	16%
BSACF30WB	Fabric	✓		24	20½	41¼	12½	16%
BSACL30WB	Leather	✓		24	20½	41¼	12½	16%

*Not available in two tone finish *Not available unfinished

BARSTOOLS

Cape Cod Stationary Bar Chair



Available Features Swivel Stationary Wood Seat Upholstered Seat Arm Kickplate

SKU	Seat Type	Arm Chair	Side Chair	Width	Depth	Height	Footrest Height (From Ground)	Backrest Height (From Seat)
LOW COUNTER 24" Seat Height								
CD24BSW	Wood		✓	25	18	40	6½	16
CD24BSF	Fabric		✓	25	18	40	6½	16
CD24BSL	Leather		✓	25	18	40	6½	16
COUNTER 26" Seat Height								
CD26BSW	Wood		✓	25	18	42	8½	16
CD26BSF	Fabric		✓	25	18	42	8½	16
CD26BSL	Leather		✓	25	18	42	8½	16
BAR 30" Seat Height								
CD30BSW	Wood		✓	25	18	46	12½	16
CD30BSF	Fabric		✓	25	18	46	12½	16
CD30BSL	Leather		✓	25	18	46	12½	16



ONLINE CONFIGURATOR

Cape Cod Swivel Bar Chair



Available Features Swivel Stationary Wood Seat Upholstered Seat Arm Kickplate

SKU	Seat Type	Arm Chair	Side Chair	Width	Depth	Height	Footrest Height (From Ground)	Backrest Height (From Seat)
LOW COUNTER 24" Seat Height								
CD24BSWW	Wood		✓	25	18	40	6½	16
CD24BSWF	Fabric		✓	25	18	40	6½	16
CD24BSWL	Leather		✓	25	18	40	6½	16
COUNTER 26" Seat Height								
CD26BSWW	Wood		✓	25	18	42	8½	16
CD26BSWF	Fabric		✓	25	18	42	8½	16
CD26BSWL	Leather		✓	25	18	42	8½	16
BAR 30" Seat Height								
CD30BSWW	Wood		✓	25	18	46	12½	16
CD30BSWF	Fabric		✓	25	18	46	12½	16
CD30BSWL	Leather		✓	25	18	46	12½	16



ONLINE CONFIGURATOR

BARSTOOLS

Claremont Stationary Bar Chair

Available Features Swivel Stationary Wood Seat Upholstered Seat Arm Kickplate



SKU	Seat Type	Arm Chair	Side Chair	Width	Depth	Height	Footrest Height (From Ground)	Backrest Height (From Seat)
LOW COUNTER 24¼" Seat Height								
CD24BSW	Wood		✓	18	14	24¼	7¾	-
CD24BSF	Fabric		✓	18	14	24¼	7¾	-
CD24BSL	Leather		✓	18	14	24¼	7¾	-
COUNTER 26¼" Seat Height								
CD26BSW	Wood		✓	18	14	26¼	7¾	-
CD26BSF	Fabric		✓	18	14	26¼	7¾	-
CD26BSL	Leather		✓	18	14	26¼	7¾	-
BAR 30¼" Seat Height								
CD30BSW	Wood		✓	18	14	30¼	7¾	-
CD30BSF	Fabric		✓	18	14	30¼	7¾	-
CD30BSL	Leather		✓	18	14	30¼	7¾	-

ONLINE CONFIGURATOR

Classic Stationary Bar Chair

Available Features Swivel Stationary Wood Seat Upholstered Seat Arm Kickplate



ONLINE CONFIGURATOR

SKU	Seat Type	Arm Chair	Side Chair	Width	Depth	Height	Footrest Height (From Ground)	Backrest Height (From Seat)
LOW COUNTER 24" Seat Height								
CCSCW24B	Wood		✓	18	19	43	6½	19
CCSCF24B	Fabric		✓	18	19	43	6½	19
CCSCL24B	Leather		✓	18	19	43	6½	19
CCACW24B	Wood	✓		24	19	43	6½	19
CCACF24B	Fabric	✓		24	19	43	6½	19
CCACL24B	Leather	✓		24	19	43	6½	19
COUNTER 26" Seat Height								
CCSCW26B	Wood		✓	18	19	45	8½	19
CCSCF26B	Fabric		✓	18	19	45	8½	19
CCSCL26B	Leather		✓	18	19	45	8½	19
CCACW26B	Wood	✓		24	19	45	8½	19
CCACF26B	Fabric	✓		24	19	45	8½	19
CCACL26B	Leather	✓		24	19	45	8½	19
BAR 30" Seat Height								
CCSCW30B	Wood		✓	18	19	49	12½	19
CCSCF30B	Fabric		✓	18	19	49	12½	19
CCSCL30B	Leather		✓	18	19	49	12½	19
CCACW30B	Wood	✓		24	19	49	12½	19
CCACF30B	Fabric	✓		24	19	49	12½	19
CCACL30B	Leather	✓		24	19	49	12½	19

*Not available in two tone finish

BARSTOOLS

Classic Swivel Bar Chair



ONLINE CONFIGURATOR

Available Features Swivel Stationary Wood Seat Upholstered Seat Arm Kickplate

20	Seat Type	Arm Chair	Side Chair	Width	Depth	Height	Footrest Height (From Ground)	Backrest Height (From Seat)
LOW COUNTER 24" Seat Height								
CCSCW24WB	Wood		✓	18	20	42	6½	19
CCSCF24WB	Fabric		✓	18	20	42	6½	19
CCSCL24WB	Leather		✓	18	20	42	6½	19
CCACW24WB	Wood	✓		24	20	42	6½	19
CCACF24WB	Fabric	✓		24	20	42	6½	19
CCACL24WB	Leather	✓		24	20	42	6½	19
COUNTER 26" Seat Height								
CCSCW26WB	Wood		✓	18	20	44	8½	19
CCSCF26WB	Fabric		✓	18	20	44	8½	19
CCSCL26WB	Leather		✓	18	20	44	8½	19
CCACW26WB	Wood	✓		24	20	44	8½	19
CCACF26WB	Fabric	✓		24	20	44	8½	19
CCACL26WB	Leather	✓		24	20	44	8½	19
BAR 30" Seat Height								
CCSCW30WB	Wood		✓	18	20	48	12½	19
CCSCF30WB	Fabric		✓	18	20	48	12½	19
CCSCL30WB	Leather		✓	18	20	48	12½	19
CCACW30WB	Wood	✓		24	20	48	12½	19
CCACF30WB	Fabric	✓		24	20	48	12½	19
CCACL30WB	Leather	✓		24	20	48	12½	19

*Not available in two tone finish

Clyde Swivel Bar Chair



ONLINE CONFIGURATOR

Available Features Swivel Stationary Wood Seat Upholstered Seat Arm Kickplate

SKU	Seat Type	Arm Chair	Side Chair	Width	Depth	Height	Footrest Height (From Ground)	Backrest Height (From Seat)
LOW COUNTER 24" Seat Height								
CYSCF24WB	Fabric		✓	18	23½	37	6½	15½
CYSCL24WB	Leather		✓	18	23½	37	6½	15½
CYACF24WB	Fabric	✓		24	23½	37	6½	15½
CYACL24WB	Leather	✓		24	23½	37	6½	15½
COUNTER 26" Seat Height								
CYSCF26WB	Fabric		✓	18	23½	39	8½	15½
CYSCL26WB	Leather		✓	18	23½	39	8½	15½
CYACF26WB	Fabric	✓		24	23½	39	8½	15½
CYACL26WB	Leather	✓		24	23½	39	8½	15½
BAR 30" Seat Height								
CYSCF30WB	Fabric		✓	18	23½	43	12½	15½
CYSCL30WB	Leather		✓	18	23½	43	12½	15½
CYACF30WB	Fabric	✓		24	23½	43	12½	15½
CYACL30WB	Leather	✓		24	23½	43	12½	15½

*Not available in two tone finish *Not available unfinished

BARSTOOLS

Cohen Stationary Bar Chair



ONLINE
CONFIGURATOR

Available Features Swivel Stationary Wood Seat Upholstered Seat Arm Kickplate

SKU	Seat Type	Arm Chair	Side Chair	Width	Depth	Height	Footrest Height (From Ground)	Backrest Height (From Seat)
LOW COUNTER 25½" Seat Height								
CNSCF24B	Fabric		✓	18	19½	41	6½	15
CNSCL24B	Leather		✓	18	19½	41	6½	15
CNACF24B	Fabric	✓		24	19½	41	6½	15
CNACL24B	Leather	✓		24	19½	41	6½	15
COUNTER 27½" Seat Height								
CNSCF26B	Fabric		✓	18	19½	43	8½	15
CNSCL26B	Leather		✓	18	19½	43	8½	15
CNACF26B	Fabric	✓		24	19½	43	8½	15
CNACL26B	Leather	✓		24	19½	43	8½	15
BAR 31½" Seat Height								
CNSCF30B	Fabric		✓	18	19½	47	12½	15
CNSCL30B	Leather		✓	18	19½	47	12½	15
CNACF30B	Fabric	✓		24	19½	47	12½	15
CNACL30B	Leather	✓		24	19½	47	12½	15

*Not available in two tone finish *Not available unfinished

Cohen Swivel Bar Chair



ONLINE
CONFIGURATOR

Available Features Swivel Stationary Wood Seat Upholstered Seat Arm Kickplate

SKU	Seat Type	Arm Chair	Side Chair	Width	Depth	Height	Footrest Height (From Ground)	Backrest Height (From Seat)
LOW COUNTER 25½" Seat Height								
CNSCF24WB	Fabric		✓	18	20	40	6½	15
CNSCL24WB	Leather		✓	18	20	40	6½	15
CNACF24WB	Fabric	✓		24	20	40	6½	15
CNACL24WB	Leather	✓		24	20	40	6½	15
COUNTER 27½" Seat Height								
CNSCF26WB	Fabric		✓	18	20	42	8½	15
CNSCL26WB	Leather		✓	18	20	42	8½	15
CNACF26WB	Fabric	✓		24	20	42	8½	15
CNACL26WB	Leather	✓		24	20	42	8½	15
BAR 31½" Seat Height								
CNSCF30WB	Fabric		✓	18	20	46	12½	15
CNSCL30WB	Leather		✓	18	20	46	12½	15
CNACF30WB	Fabric	✓		24	20	46	12½	15
CNACL30WB	Leather	✓		24	20	46	12½	15

*Not available in two tone finish *Not available unfinished

BARSTOOLS

Conner Stationary Bar Chair



ONLINE
CONFIGURATOR

Available Features Swivel Stationary Wood Seat Upholstered Seat Arm Kickplate

21	Seat Type	Arm Chair	Side Chair	Width	Depth	Height	Footrest Height (From Ground)	Backrest Height (From Seat)
LOW COUNTER 24" Seat Height								
CRSCW24B	Wood		✓	18	21	43	6½	19¼
CRSCF24B	Fabric		✓	18	21	43	6½	19¼
CRSCL24B	Leather		✓	18	21	43	6½	19¼
CRACW24B	Wood	✓		24	21	43	6½	19¼
CRACF24B	Fabric	✓		24	21	43	6½	19¼
CRACL24B	Leather	✓		24	21	43	6½	19¼
COUNTER 26" Seat Height								
CRSCW26B	Wood		✓	18	21	45	8½	19¼
CRSCF26B	Fabric		✓	18	21	45	8½	19¼
CRSCL26B	Leather		✓	18	21	45	8½	19¼
CRACW26B	Wood	✓		24	21	45	8½	19¼
CRACF26B	Fabric	✓		24	21	45	8½	19¼
CRACL26B	Leather	✓		24	21	45	8½	19¼
BAR 30" Seat Height								
CRSCW30B	Wood		✓	18	21	49	12½	19¼
CRSCF30B	Fabric		✓	18	21	49	12½	19¼
CRSCL30B	Leather		✓	18	21	49	12½	19¼
CRACW30B	Wood	✓		24	21	49	12½	19¼
CRACF30B	Fabric	✓		24	21	49	12½	19¼
CRACL30B	Leather	✓		24	21	49	12½	19¼

*Not available in two tone finish

BARSTOOLS

Conner Swivel Bar Chair



ONLINE CONFIGURATOR

Available Features Swivel Stationary Wood Seat Upholstered Seat Arm Kickplate

SKU	Seat Type	Arm Chair	Side Chair	Width	Depth	Height	Footrest Height (From Ground)	Backrest Height (From Seat)
LOW COUNTER 24" Seat Height								
CRSCW24WB	Wood		✓	18	22	42	6½	19¼
CRSCF24WB	Fabric		✓	18	22	42	6½	19¼
CRSCL24WB	Leather		✓	18	22	42	6½	19¼
CRACW24WB	Wood	✓		24	22	42	6½	19¼
CRACF24WB	Fabric	✓		24	22	42	6½	19¼
CRACL24WB	Leather	✓		24	22	42	6½	19¼
COUNTER 26" Seat Height								
CRSCW26WB	Wood		✓	18	22	44	8½	19¼
CRSCF26WB	Fabric		✓	18	22	44	8½	19¼
CRSCL26WB	Leather		✓	18	22	44	8½	19¼
CRACW26WB	Wood	✓		24	22	44	8½	19¼
CRACF26WB	Fabric	✓		24	22	44	8½	19¼
CRACL26WB	Leather	✓		24	22	44	8½	19¼
BAR 30" Seat Height								
CRSCW30WB	Wood		✓	18	22	48	12½	19¼
CRSCF30WB	Fabric		✓	18	22	48	12½	19¼
CRSCL30WB	Leather		✓	18	22	48	12½	19¼
CRACW30WB	Wood	✓		24	22	48	12½	19¼
CRACF30WB	Fabric	✓		24	22	48	12½	19¼
CRACL30WB	Leather	✓	✓	24	22	48	12½	19¼

*Not available in two tone finish

Elara Stationary Bar Chair



ONLINE CONFIGURATOR

Available Features Swivel Stationary Wood Seat Upholstered Seat Arm Kickplate

SKU	Seat Type	Arm Chair	Side Chair	Width	Depth	Height	Footrest Height (From Ground)	Backrest Height (From Seat)
LOW COUNTER 24" Seat Height								
EASCF24B	Fabric		✓	18½	16¼	44	5	20
EASCL24B	Leather		✓	18½	16¼	44	5	20
COUNTER 26" Seat Height								
EASCF26B	Fabric		✓	18½	16¼	46	7	20
EASCL26B	Leather		✓	18½	16¼	46	7	20
BAR 30" Seat Height								
EASCF30B	Fabric		✓	18½	16¼	50	11	20
EASCL30B	Leather		✓	18½	16¼	50	11	20

*Not available in two tone finish *Not available unfinished



BARSTOOLS

Enzo Stationary Bar Chair



Available Features Swivel Stationary Wood Seat Upholstered Seat Arm Kickplate

SKU	Seat Type	Arm Chair	Side Chair	Width	Depth	Height	Footrest Height (From Ground)	Backrest Height (From Seat)
LOW COUNTER 24" Seat Height								
EOSCW24B	Wood		✓	17	18½	33	7¾	9¼
EOSCF24B	Fabric		✓	17	18½	33	7¾	9¼
EOSCL24B	Leather		✓	17	18½	33	7¾	9¼
COUNTER 26" Seat Height								
EOSCW26B	Wood		✓	17	18½	35	9¾	9¼
EOSCF26B	Fabric		✓	17	18½	35	9¾	9¼
EOSCL26B	Leather		✓	17	18½	35	9¾	9¼
BAR 30" Seat Height								
EOSCW30B	Wood		✓	17	18½	39	13¾	9¼
EOSCF30B	Fabric		✓	17	18½	39	13¾	9¼
EOSCL30B	Leather		✓	17	18½	39	13¾	9¼

ONLINE CONFIGURATOR

Hatfield Stationary Bar Chair



ONLINE CONFIGURATOR

Available Features Swivel Stationary Wood Seat Upholstered Seat Arm Kickplate

SKU	Seat Type	Arm Chair	Side Chair	Width	Depth	Height	Footrest Height (From Ground)	Backrest Height (From Seat)
LOW COUNTER 24" Seat Height								
HASCW24B	Wood		✓	18	21¼	41¾	6½	18
HASCF24B	Fabric		✓	18	21¼	41¾	6½	18
HASCL24B	Leather		✓	18	21¼	41¾	6½	18
HAACW24B	Wood	✓		24	21¼	41¾	6½	18
HAACF24B	Fabric	✓		24	21¼	41¾	6½	18
HAACL24B	Leather	✓		24	21¼	41¾	6½	18
COUNTER 26" Seat Height								
HASCW26B	Wood		✓	18	21¼	43¾	8½	18
HASCF26B	Fabric		✓	18	21¼	43¾	8½	18
HASCL26B	Leather		✓	18	21¼	43¾	8½	18
HAACW26B	Wood	✓		24	21¼	43¾	8½	18
HAACF26B	Fabric	✓		24	21¼	43¾	8½	18
HAACL26B	Leather	✓		24	21¼	43¾	8½	18
BAR 30" Seat Height								
HASCW30B	Wood		✓	18	21¼	47¾	12½	18
HASCF30B	Fabric		✓	18	21¼	47¾	12½	18
HASCL30B	Leather		✓	18	21¼	47¾	12½	18
HAACW30B	Wood	✓		24	21¼	47¾	12½	18
HAACF30B	Fabric	✓		24	21¼	47¾	12½	18
HAACL30B	Leather	✓	✓	24	21¼	47¾	12½	18

*Not available in two tone finish

BARSTOOLS

Hatfield Swivel Bar Chair



ONLINE
CONFIGURATOR

Available Features Swivel Stationary Wood Seat Upholstered Seat Arm Kickplate

HAACL24WB	Seat Type	Arm Chair	Side Chair	Width	Depth	Height	Footrest Height (From Ground)	Backrest Height (From Seat)
LOW COUNTER 24" Seat Height								
HASCW24WB	Wood		✓	18	22	41	6½	18
HASCF24WB	Fabric		✓	18	22	41	6½	18
HASCL24WB	Leather		✓	18	22	41	6½	18
HAACW24WB	Wood	✓		24	22	41	6½	18
HAACF24WB	Fabric	✓		24	22	41	6½	18
HAACL24WB	Leather	✓		24	22	41	6½	18
COUNTER 26" Seat Height								
HASCW26WB	Wood		✓	18	22	43	8½	18
HASCF26WB	Fabric		✓	18	22	43	8½	18
HASCL26WB	Leather		✓	18	22	43	8½	18
HAACW26WB	Wood	✓		24	22	43	8½	18
HAACF26WB	Fabric	✓		24	22	43	8½	18
HAACL26WB	Leather	✓		24	22	43	8½	18
BAR 30" Seat Height								
HASCW30WB	Wood		✓	18	22	47	12½	18
HASCF30WB	Fabric		✓	18	22	47	12½	18
HASCL30WB	Leather		✓	18	22	47	12½	18
HAACW30WB	Wood	✓		24	22	47	12½	18
HAACF30WB	Fabric	✓		24	22	47	12½	18
HAACL30WB	Leather	✓		24	22	47	12½	18

*Not available in two tone finish



BARSTOOLS

Kendall Stationary Bar Chair



ONLINE
CONFIGURATOR

Available Features Swivel Stationary Wood Seat Upholstered Seat Arm Kickplate

SKU	Seat Type	Arm Chair	Side Chair	Width	Depth	Height	Footrest Height (From Ground)	Backrest Height (From Seat)
LOW COUNTER 24" Seat Height								
KLSCW24B	Wood		✓	18	21½	45½	6½	22
KLSCF24B	Fabric		✓	18	21½	45½	6½	22
KLACL24B	Leather		✓	18	21½	45½	6½	22
KLACW24B	Wood	✓		24	21½	45½	6½	22
KLACF24B	Fabric	✓		24	21½	45½	6½	22
KLACL24B	Leather	✓		24	21½	45½	6½	22
COUNTER 26" Seat Height								
KLSCW26B	Wood		✓	18	21½	47½	8½	22
KLSCF26B	Fabric		✓	18	21½	47½	8½	22
KLACL26B	Leather		✓	18	21½	47½	8½	22
KLACW26B	Wood	✓		24	21½	47½	8½	22
KLACF26B	Fabric	✓		24	21½	47½	8½	22
KLACL26B	Leather	✓		24	21½	47½	8½	22
BAR 30" Seat Height								
KLSCW30B	Wood		✓	18	21½	51½	12½	22
KLSCF30B	Fabric		✓	18	21½	51½	12½	22
KLACL30B	Leather		✓	18	21½	51½	12½	22
KLACW30B	Wood	✓		24	21½	51½	12½	22
KLACF30B	Fabric	✓		24	21½	51½	12½	22
KLACL30B	Leather	✓		24	21½	51½	12½	22

*Not available in two tone finish

BARSTOOLS

Kendall Swivel Bar Chair



ONLINE
CONFIGURATOR

Available Features Swivel Stationary Wood Seat Upholstered Seat Arm Kickplate

22	Seat Type	Arm Chair	Side Chair	Width	Depth	Height	Footrest Height (From Ground)	Backrest Height (From Seat)
LOW COUNTER 24" Seat Height								
KLSCW24WB	Wood		✓	18	22	45	6½	22
KLSCF24WB	Fabric		✓	18	22	45	6½	22
KLACL24WB	Leather		✓	18	22	45	6½	22
KLACW24WB	Wood	✓		24	22	45	6½	22
KLACF24WB	Fabric	✓		24	22	45	6½	22
KLACL24WB	Leather	✓		24	22	45	6½	22
COUNTER 26" Seat Height								
KLSCW26WB	Wood		✓	18	22	47	8½	22
KLSCF26WB	Fabric		✓	18	22	47	8½	22
KLACL26WB	Leather		✓	18	22	47	8½	22
KLACW26WB	Wood	✓		24	22	47	8½	22
KLACF26WB	Fabric	✓		24	22	47	8½	22
KLACL26WB	Leather	✓		24	22	47	8½	22
BAR 30" Seat Height								
KLSCW30WB	Wood		✓	18	22	51	12½	22
KLSCF30WB	Fabric		✓	18	22	51	12½	22
KLACL30WB	Leather		✓	18	22	51	12½	22
KLACW30WB	Wood	✓		24	22	51	12½	22
KLACF30WB	Fabric	✓		24	22	51	12½	22
KLACL30WB	Leather	✓		24	22	51	12½	22

*Not available in two tone finish

BARSTOOLS

Kennebec Stationary Bar Chair



ONLINE
CONFIGURATOR

Available Features Swivel Stationary Wood Seat Upholstered Seat Arm Kickplate

24	Seat Type	Arm Chair	Side Chair	Width	Depth	Height	Footrest Height (From Ground)	Backrest Height (From Seat)
LOW COUNTER 24" Seat Height								
KCSCW24B	Wood		✓	18	21	45¾	6½	22
KCSCF24B	Fabric		✓	18	21	45¾	6½	22
KCSCL24B	Leather		✓	18	21	45¾	6½	22
KCACW24B	Wood	✓		24	21	45¾	6½	22
KCACF24B	Fabric	✓		24	21	45¾	6½	22
KCACL24B	Leather	✓		24	21	45¾	6½	22
COUNTER 26" Seat Height								
KCSCW26B	Wood		✓	18	21	47¾	8½	22
KCSCF26B	Fabric		✓	18	21	47¾	8½	22
KCSCL26B	Leather		✓	18	21	47¾	8½	22
KCACW26B	Wood	✓		24	21	47¾	8½	22
KCACF26B	Fabric	✓		24	21	47¾	8½	22
KCACL26B	Leather	✓		24	21	47¾	8½	22
BAR 30" Seat Height								
KCSCW30B	Wood		✓	18	21	51¾	12½	22
KCSCF30B	Fabric		✓	18	21	51¾	12½	22
KCSCL30B	Leather		✓	18	21	51¾	12½	22
KCACW30B	Wood	✓		24	21	51¾	12½	22
KCACF30B	Fabric	✓		24	21	51¾	12½	22
KCACL30B	Leather	✓		24	21	43	12½	22

*Not available in two tone finish

BARSTOOLS

Kennebec Swivel Bar Chair



ONLINE
CONFIGURATOR

Available Features Swivel Stationary Wood Seat Upholstered Seat Arm Kickplate

SKU	Seat Type	Arm Chair	Side Chair	Width	Depth	Height	Footrest Height (From Ground)	Backrest Height (From Seat)
LOW COUNTER 24" Seat Height								
KCSCW24WB	Wood		✓	18	21½	45	6½	22
KCSCF24WB	Fabric		✓	18	21½	45	6½	22
KCSCL24WB	Leather		✓	18	21½	45	6½	22
KCACW24WB	Wood	✓		24	21½	45	6½	22
KCACF24WB	Fabric	✓		24	21½	45	6½	22
KCACL24WB	Leather	✓		24	21½	45	6½	22
COUNTER 26" Seat Height								
KCSCW26WB	Wood		✓	18	21½	47	8½	22
KCSCF26WB	Fabric		✓	18	21½	47	8½	22
KCSCL26WB	Leather		✓	18	21½	47	8½	22
KCACW26WB	Wood	✓		24	21½	47	8½	22
KCACF26WB	Fabric	✓		24	21½	47	8½	22
KCACL26WB	Leather	✓		24	21½	47	8½	22
BAR 30" Seat Height								
KCSCW30WB	Wood		✓	18	21½	51	12½	22
KCSCF30WB	Fabric		✓	18	21½	51	12½	22
KCSCL30WB	Leather		✓	18	21½	51	12½	22
KCACW30WB	Wood	✓		24	21½	51	12½	22
KCACF30WB	Fabric	✓		24	21½	51	12½	22
KCACL30WB	Leather	✓		24	21½	51	12½	22

*Not available in two tone finish

BARSTOOLS

Livonia Swivel Bar Chair



Available Features Swivel Stationary Wood Seat Upholstered Seat Arm Kickplate

SKU	Seat Type	Arm Chair	Side Chair	Width	Depth	Height	Footrest Height (From Ground)	Backrest Height (From Seat)
LOW COUNTER 24" Seat Height								
LVACF24WB	Fabric	<input checked="" type="checkbox"/>	<input type="checkbox"/>	24	17	41	6½	18
LVACL24WB	Leather	<input checked="" type="checkbox"/>	<input type="checkbox"/>	24	17	41	6½	18
COUNTER 26" Seat Height								
LVACF26WB	Fabric	<input checked="" type="checkbox"/>	<input type="checkbox"/>	24	17	43	8½	18
LVACL26WB	Leather	<input checked="" type="checkbox"/>	<input type="checkbox"/>	24	17	43	8½	18
BAR 30" Seat Height								
LVACF30WB	Fabric	<input checked="" type="checkbox"/>	<input type="checkbox"/>	24	17	47	12½	18
LVACL30WB	Leather	<input checked="" type="checkbox"/>	<input type="checkbox"/>	24	17	47	12½	18

*Not available in two tone finish *Not available unfinished

ONLINE CONFIGURATOR

Luca Swivel Bar Chair



Available Features Swivel Stationary Wood Seat Upholstered Seat Arm Kickplate

SKU	Seat Type	Arm Chair	Side Chair	Width	Depth	Height	Footrest Height (From Ground)	Backrest Height (From Seat)
LOW COUNTER 24" Seat Height								
LASCF24WB	Fabric	<input type="checkbox"/>	<input checked="" type="checkbox"/>	19½	21½	36	6½	12½
LASCL24WB	Leather	<input type="checkbox"/>	<input checked="" type="checkbox"/>	19½	21½	36	6½	12½
COUNTER 26" Seat Height								
LASCF26WB	Fabric	<input type="checkbox"/>	<input checked="" type="checkbox"/>	19½	21½	38	8½	12½
LASCL26WB	Leather	<input type="checkbox"/>	<input checked="" type="checkbox"/>	19½	21½	38	8½	12½
BAR 30" Seat Height								
LASCF30WB	Fabric	<input type="checkbox"/>	<input checked="" type="checkbox"/>	19½	21½	42	12½	12½
LASCL30WB	Leather	<input type="checkbox"/>	<input checked="" type="checkbox"/>	19½	21½	42	12½	12½

*Not available in two tone finish *Not available unfinished

ONLINE CONFIGURATOR

BARSTOOLS

Madrid Stationary Bar Chair



Available Features Swivel Stationary Wood Seat Upholstered Seat Arm Kickplate

SKU	Seat Type	Arm Chair	Side Chair	Width	Depth	Height	Footrest Height (From Ground)	Backrest Height (From Seat)
LOW COUNTER 24" Seat Height								
MDSCF24B	Fabric		✓	19½	18	41	5	17½
MDSCF24B	Leather		✓	19½	18	41	5	17½
COUNTER 26" Seat Height								
MDSCF26B	Fabric		✓	19½	18	43	7	17½
MDSCL26B	Leather		✓	19½	18	43	7	17½
BAR 30" Seat Height								
MDSCF30B	Fabric		✓	19½	18	47	11	17½
MDSCL30B	Leather		✓	19½	18	47	11	17½

*Not available in two tone finish *Not available unfinished

ONLINE CONFIGURATOR



BARSTOOLS

Old Mission Stationary Bar Chair



ONLINE CONFIGURATOR

Available Features Swivel Stationary Wood Seat Upholstered Seat Arm Kickplate

17¼	Seat Type	Arm Chair	Side Chair	Width	Depth	Height	Footrest Height (From Ground)	Backrest Height (From Seat)
LOW COUNTER 24" Seat Height								
OMSCW24B	Wood		✓	18	20½	41	6½	17¼
OMSCF24B	Fabric		✓	18	20½	41	6½	17¼
OMSCL24B	Leather		✓	18	20½	41	6½	17¼
OMACW24B	Wood	✓		24	20½	41	6½	17¼
OMACF24B	Fabric	✓		24	20½	41	6½	17¼
OMACL24B	Leather	✓		24	20½	41	6½	17¼
COUNTER 26" Seat Height								
OMSCW26B	Wood		✓	18	20½	43	8½	17¼
OMSCF26B	Fabric		✓	18	20½	43	8½	17¼
OMSCL26B	Leather		✓	18	20½	43	8½	17¼
OMACW26B	Wood	✓		24	20½	43	8½	17¼
OMACF26B	Fabric	✓		24	20½	43	8½	17¼
OMACL26B	Leather	✓		24	20½	43	8½	17¼
BAR 30" Seat Height								
OMSCW30B	Wood		✓	18	20½	47	12½	17¼
OMSCF30B	Fabric		✓	18	20½	47	12½	17¼
OMSCL30B	Leather		✓	18	20½	47	12½	17¼
OMACW30B	Wood	✓		24	20½	47	12½	17¼
OMACF30B	Fabric	✓		24	20½	47	12½	17¼
OMACL30B	Leather	✓		24	20½	47	12½	17¼

*Not available in two tone finish



Quinn Swivel Bar Chair
Shown in Oak with #113 Oatmeal with C22-12 Fincher Fabric Seat

BARSTOOLS

Old Mission Swivel Bar Chair



ONLINE CONFIGURATOR

Available Features Swivel Stationary Wood Seat Upholstered Seat Arm Kickplate

17¼	Seat Type	Arm Chair	Side Chair	Width	Depth	Height	Footrest Height (From Ground)	Backrest Height (From Seat)
LOW COUNTER 24" Seat Height								
OMSCW24WB	Wood		✓	18	21	40¼	6½	17¼
OMSCF24WB	Fabric		✓	18	21	40¼	6½	17¼
OMSCL24WB	Leather		✓	18	21	40¼	6½	17¼
OMACW24WB	Wood	✓		24	21	40¼	6½	17¼
OMACF24WB	Fabric	✓		24	21	40¼	6½	17¼
OMACL24WB	Leather	✓		24	21	40¼	6½	17¼
COUNTER 26" Seat Height								
OMSCW26WB	Wood		✓	18	21	42¼	8½	17¼
OMSCF26WB	Fabric		✓	18	21	42¼	8½	17¼
OMSCL26WB	Leather		✓	18	21	42¼	8½	17¼
OMACW26WB	Wood	✓		24	21	42¼	8½	17¼
OMACF26WB	Fabric	✓		24	21	42¼	8½	17¼
OMACL26WB	Leather	✓		24	21	42¼	8½	17¼
BAR 30" Seat Height								
OMSCW30WB	Wood		✓	18	21	46¼	12½	17¼
OMSCF30WB	Fabric		✓	18	21	46¼	12½	17¼
OMSCL30WB	Leather		✓	18	21	46¼	12½	17¼
OMACW30WB	Wood	✓		24	21	46¼	12½	17¼
OMACF30WB	Fabric	✓		24	21	46¼	12½	17¼
OMACL30WB	Leather	✓		24	21	46¼	12½	17¼

*Not available in two tone finish

Quinn Swivel Bar Chair



Available Features Swivel Stationary Wood Seat Upholstered Seat Arm Kickplate

SKU	Seat Type	Arm Chair	Side Chair	Width	Depth	Height	Footrest Height (From Ground)	Backrest Height (From Seat)
LOW COUNTER 24" Seat Height								
QNSCF24WB	Fabric		✓	18	21¾	35	6½	10
QNSCL24WB	Leather		✓	18	21¾	35	6½	10
COUNTER 26" Seat Height								
QNSCF26WB	Fabric		✓	18	21¾	37	8½	10
QNSCL26WB	Leather		✓	18	21¾	37	8½	10
BAR 30" Seat Height								
QNSCF30WB	Fabric		✓	18	21¾	41	12½	10
QNSCL30WB	Leather		✓	18	21¾	41	12½	10

*Not available in two tone finish *Not available unfinished



ONLINE CONFIGURATOR

BARSTOOLS

Richfield Stationary Bar Chair



ONLINE CONFIGURATOR

Available Features Swivel Stationary Wood Seat Upholstered Seat Arm Kickplate

SKU	Seat Type	Arm Chair	Side Chair	Width	Depth	Height	Footrest Height (From Ground)	Backrest Height (From Seat)
LOW COUNTER 24" Seat Height								
NC-9036SCW24B	Wood		✓	18	20¾	44½	6½	21
NC-9036SCW24B	Fabric		✓	18	20¾	44½	6½	21
NC-9036SCL24B	Leather		✓	18	20¾	44½	6½	21
NC-9036ACW24B	Wood	✓		24	20¾	44½	6½	21
NC-9036ACF24B	Fabric	✓		24	20¾	44½	6½	21
NC-9036ACL24B	Leather	✓		24	20¾	44½	6½	21
COUNTER 26" Seat Height								
NC-9036SCW26B	Wood		✓	18	20¾	46½	8½	21
NC-9036SCF26B	Fabric		✓	18	20¾	46½	8½	21
NC-9036SCL26B	Leather		✓	18	20¾	46½	8½	21
NC-9036ACW26B	Wood	✓		24	20¾	46½	8½	21
NC-9036ACF26B	Fabric	✓		24	20¾	46½	8½	21
NC-9036ACL26B	Leather	✓		24	20¾	46½	8½	21
BAR 30" Seat Height								
NC-9036SCW30B	Wood		✓	18	20¾	50½	12½	21
NC-9036SCF30B	Fabric		✓	18	20¾	50½	12½	21
NC-9036SCL30B	Leather		✓	18	20¾	50½	12½	21
NC-9036ACW30B	Wood	✓		24	20¾	50½	12½	21
NC-9036ACF30B	Fabric	✓		24	20¾	50½	12½	21
NC-9036ACL30B	Leather	✓		24	20¾	50½	12½	21

*Not available in two tone finish

Rylee Stationary Bar Chair



Available Features Swivel Stationary Wood Seat Upholstered Seat Arm Kickplate

SKU	Seat Type	Arm Chair	Side Chair	Width	Depth	Height	Footrest Height (From Ground)	Backrest Height (From Seat)
LOW COUNTER 24" Seat Height								
RESCF24B	Fabric		✓	18	22½	34	7	10
RESCL24B	Leather		✓	18	22½	34	7	10
COUNTER 26" Seat Height								
RESCF26B	Fabric		✓	18	22½	36	8½	10
RESCL26B	Leather		✓	18	22½	36	8½	10
BAR 30" Seat Height								
RESCF30B	Fabric		✓	18	22½	40	12½	10
RESCL30B	Leather		✓	18	22½	40	12½	10

*Not available unfinished

ONLINE CONFIGURATOR

BARSTOOLS

Richfield Swivel Bar Chair



ONLINE
CONFIGURATOR

Available Features Swivel Stationary Wood Seat Upholstered Seat Arm Kickplate

44	Seat Type	Arm Chair	Side Chair	Width	Depth	Height	Footrest Height (From Ground)	Backrest Height (From Seat)
LOW COUNTER 24" Seat Height								
NC-9036SCW24WB	Wood		✓	18	21½	44	6½	21
NC-9036SCF24WB	Fabric		✓	18	21½	44	6½	21
NC-9036SCL24WB	Leather		✓	18	21½	44	6½	21
NC-9036ACW24WB	Wood	✓		24	21½	44	6½	21
NC-9036ACF24WB	Fabric	✓		24	21½	44	6½	21
NC-9036ACL24WB	Leather	✓		24	21½	44	6½	21
COUNTER 26" Seat Height								
NC-9036SCW26WB	Wood		✓	18	21½	46	8½	21
NC-9036SCF26WB	Fabric		✓	18	21½	46	8½	21
NC-9036SCL26WB	Leather		✓	18	21½	46	8½	21
NC-9036ACW26WB	Wood	✓		24	21½	46	8½	21
NC-9036ACF26WB	Fabric	✓		24	21½	46	8½	21
NC-9036ACL26WB	Leather	✓		24	21½	46	8½	21
BAR 30" Seat Height								
NC-9036SCW30WB	Wood		✓	18	21½	50	12½	21
NC-9036SCF30WB	Fabric		✓	18	21½	50	12½	21
NC-9036SCL30WB	Leather		✓	18	21½	50	12½	21
NC-9036ACW30WB	Wood	✓		24	21½	50	12½	21
NC-9036ACF30WB	Fabric	✓		24	21½	50	12½	21
NC-9036ACL30WB	Leather	✓		24	21½	50	12½	21

*Not available in two tone finish



Protective Stretcher Cover (#PC)

All bar chairs will come standard with black kickplate if available.

BENCHES



Ashton Bench

17" d x 19" h
 Fabric, 36" w #ANBEN36F
 Fabric, 48" w #ANBEN48F
 Fabric, 60" w #ANBEN60F
 Fabric, 72" w #ANBEN72F
 Leather, 36" w #ANBEN36L
 Leather, 48" w #ANBEN48L
 Leather, 60" w #ANBEN60L
 Leather, 72" w #ANBEN72L
Not available unfinished

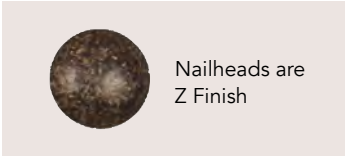

Nailheads are
 Z Finish

Caspian Expandable Bench

#CPEXB
 48" - 96" w x 13" d x 18" h

Caspian Bench (not shown)

13" d x 18" h
 36" w #CPBEN36
 48" w #CPBEN48
 60" w #CPBEN60
 72" w #CPBEN72



Features Plank Style Top



Leg Bench

Options L to R
 Specify leg style by
 adding selected
 Leg SKU to end of
 Bench SKU

#L1 Brookline
 #L4 Hoosier
 #L9 Round Shaker
 #L10 Classic Shaker

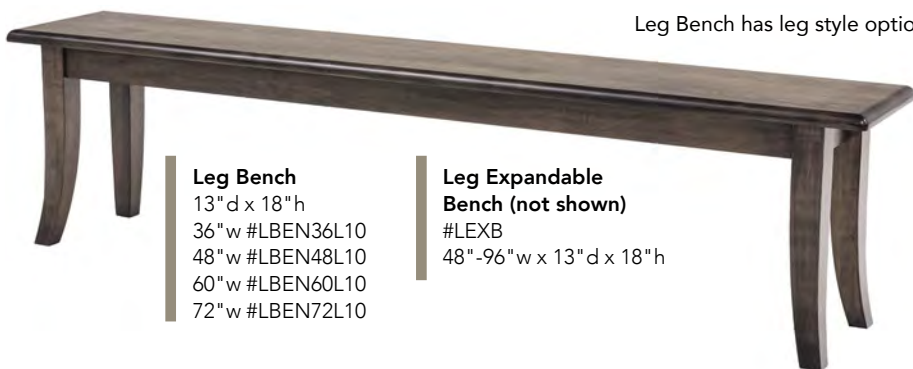

Leg Bench has leg style option

Leg Bench

13" d x 18" h
 36" w #LBEN36L10
 48" w #LBEN48L10
 60" w #LBEN60L10
 72" w #LBEN72L10

Leg Expandable Bench (not shown)

#LEXB
 48" - 96" w x 13" d x 18" h



Henning Bench

#HGBEN54
 54" w x 16" d x 18" h



Hayworth Bench

13" d x 18" h
 36" w #HHBEN36
 48" w #HHBEN48
 60" w #HHBEN60
 72" w #HHBEN72

BENCHES

Mission Expandable Bench

#MNEXB

48"-96" w x 13" d x 18" h

- Three 16" Leaves
- Leaf Holder



Mission Bench

13" d x 18" h

36" w #MNBEN36

48" w #MNBEN48

60" w #MNBEN60

72" w #MNBEN72



Simplicity Solid Top Bench

#51-36BEN

Popular Sizes:

#51-36BEN 36"

#51-48BEN 48"

#51-60BEN 60"

#51-72BEN 72"

Simplicity Expandable Bench

#51-1401EXB



Wasilla Bench

#WABEN36 36"

#WABEN48 48"

#WABEN60 60"

#WABEN72 72"

Wasilla Expandable Bench

#WAEXB



Xander Live Edge Bench

16" d x 18" h

60" w #XR BEN60

72" w #XR BEN72

84" w #XR BEN84

90" w #XR BEN90



STORAGE

OPTIONS

Why, you ask, do we make our beautiful hutches, buffets, and sideboards in the time-honored tradition of handcrafted furniture- building?

**BECAUSE
YOU WOULDN'T
WANT IT ANY
OTHER WAY.**

We are true craftsmen, dedicated to building and finishing every piece of furniture by hand, one piece at a time. Because you wouldn't expect any less from Fusion Designs.

HUTCHES

Caspian



Caspian Hutch

#CPBFT40 (2-door)
42 1/2" w x 20" d x 46" h

#CPBFT60 (3-door)
60 1/2" w x 20" d x 46" h

#CPBFT80 (4-door)
80 1/2" w x 20" d x 46" h

- Flush doors with light guard
- Antique glass sides
- Leaded glass doors
- Open deck
- Touch lighting
- Soft-close doors
- Hardware options
(see Features & Options)

Caspian Buffet

#CPBFB40 (2-door)
40" w x 20" d x 34" h

#CPBFB60 (3-door)
58" w x 20" d x 34" h

#CPBFB80 (4-door)
76" w x 20" d x 34" h

Total height buffet with hutch is 80"

- 1 fixed shelf in base
- 1 adjustable glass shelf w/ plate groove in top

Classic



Classic Hutch

#CCBFT40 (2-door)
40" w x 20" d x 46" h

#CCBFT56 (3-door)
56" w x 20" d x 46" h

#CCBFT72 (4-door)
72" w x 20" d x 46" h

- Beveled glass in doors
- Recessed touch lighting
- Soft-close doors

Classic Buffet

#CCBFB40 (2-door)
38 7/8" w x 20" d x 34" h

#CCBFB56 (3-door)
56 3/8" w x 20" d x 34" h

#CCBFB72 (4-door)
72" w x 20" d x 34" h

- Soft-close doors & drawers
- Hardware options (see Features & Options)

Total height buffet with hutch is 80"

- 1 fixed shelf in base
- 1 glass shelf w/ plate groove in top

Edmonton



Edmonton Corner Hutch

#ENBFT
46" w x 25" d x 56.5" h

- Recessed touch lighting
- Inset doors
- Soft-close doors

Edmonton Corner Buffet

#ENBFB
32 1/2" w x 25" d x 34" h

- Soft-close doors
- Hardware options (see Features & Options)

Standard hardware is E-5

Total height buffet with hutch is 90.5"

- 1 shelf in base
- 2 shelves in top

Elara Display Chest



Elara Display Chest
#EADPC
40" w x 19" d x 78" h
Chest Top: 40" w

- Soft-closing, full extension, undermount drawer guides
- Dovetailed, solid wood drawers
- Recessed touch lighting
- Soft-close doors
- Display Chest includes 2 Adjustable glass shelves

See hardware page in Features and Options section



Farmville



Farmville Hutch
#FEBFT (2 Door)
60.5" w x 20" d x 46 1/2" h

#FEBFT35 (1 Door)
35" w x 20" d x 46 1/2" h
Hutch Top: 35" w

Farmville Buffet
#FEBF (3 Drawer, 2 Door)
57" w x 20" d x 35" h

#FEBF31 (1 Drawer, 2 Door)
31" w x 20" d x 35" h

- Soft-closing, full extension, undermount drawer slides
- Soft closing doors on buffet only
- Dovetailed, solid wood drawers
- Recessed touch lighting

See hardware page in the Features & Options section

Total height buffet with hutch is 81 1/2"
- 2 shelves per section in base
- 2 shelves in top

Hayworth



Hayworth Hutch
#HHBFT46 (2-door)
47" w x 21 1/2" d x 46" h

#HHBFT62 (3-door)
62" w x 21 1/2" d x 46" h

- #HHBFT80 (4-door)
80" w x 21 1/2" d x 46" h
- Recessed touch lighting
 - Beveled glass doors
 - Soft-close doors
 - Ebony inlays

Hayworth Buffet
#HHBFB46 (2-door)
43 1/2" w x 21 1/2" d x 35" h

#HHBFB62 (3-door)
61 1/2" w x 21 1/2" d x 35" h

- #HHBFB80 (4-door)
76 1/2" w x 21 1/2" d x 35" h
- Soft-close drawers & doors

Total height buffet with hutch is 81"
- 1 shelf in base
- 1 shelf in top

Melbourne



Melbourne Curio
#MECO
40" w x 18" d x 78.5" h
Three adjustable glass shelves
Touch lighting
Soft-closing doors
No hardware options on hutch

HUTCHES

Santiago

Santiago Curio

#SGCO

Cabinets: 18.5" d x 36" w x 86" h

1 Adjustable Glass Shelf w/ LED

Lights

1 Adjustable Wood Shelf

Santiago Wine Cabinet

#SCWE

1 Adjustable Wood Shelf

Wine Rack & Stemware Holder



BUFFETS & SIDEBOARDS

Bartlett



- | | | |
|--|---|--|
| #BRBF54 (2-door)
54"w x 20"d x 40"h | #BRBF454 (4-door)
54"w x 20"d x 40"h | – Soft-closing, full extension,
undermount drawer slides |
| #BRBF60 (2-door)
60"w x 20"d x 40"h | #BRBF460 (4-door)
60"w x 20"d x 40"h | – Soft closing doors |
| #BRBF72 (2-door)
72"w x 20"d x 40"h | #BRBF472 (4-door)
72"w x 20"d x 40" | – Dovetailed, solid wood drawers |
| | | – 1 shelf per section |
| | | – 4-door unit comes with doors and
shelf instead of wine rack |
| | | See hardware page in Features &
Options section |

Celina Buffet



- | | |
|---|---|
| #CLBF54 (4 door, 1 drawer)
54"w x 20"d x 40" h | – Soft-closing, full extension,
undermount drawer slides |
| #CLBF60 (4 door, 1 drawer)
60"w x 20"d x 40" h | – Soft closing doors |
| #CLBF72 (4 door, 1 drawer)
72"w x 20"d x 40" h | – Dovetailed, solid wood drawers |
| | – Radius doors |
| | – Outside doors, 1 shelf per door
stationary (if no wine rack,
1 shelf in center) |

Copenhagen Leaf Storage Cabinet



- #CHBF60 60"
60"w x 19"d x 36"h
- Available size: 60" length- 60" stores 36", 42", or 48" long leaves
 - 36" standard height
 - Standard depth is 19" and will need to add 6" in depth to store 16" wide leaves
 - Cabinets can store up to 10 leaves w/ skirt
 - Standard with two adjustable shelves

Elara Shelf Chest



- #EASC
38"w x 18"d x 38"h
- Shelf chest includes 2 adjustable shelves that can be used as wine bottle holders or regular shelves
 - See hardware page in Features and Options section

Elara Door Chest



- #EADC
 38" w x 18" d x 38" h
 – Soft-close doors
 – Includes 2 adjustable shelves
 – See hardware pg. 24 in Features and Options section

Goshen Buffet



- #GNBF60
 60" w x 20" d x 40" h
 – Textured glass
 – 1 adjustable wood shelf
 – Inset doors and drawers
 – Soft-closing, full extension, undermount drawer slides
 – Dovetailed solid wood drawers
 – Soft-close doors
 – Hardware (see Features & Options)



- Elara Door Chest & Elara Shelf Chest
 Individual units can be combined to form
 1 large buffet

Harmony Buffet



#HYBF65ST03
 65" w x 19" d x 36" h

#HYBF35RT03
 34 3/4" w x 19" d x 36" h

*See pages 148 & 149 for options and details for the Harmony Buffets



#HHBFB46 (2-door)
 (2 door, 2 drawer)
 43 1/2" w x 21 1/2" d x 35" h

#HHBFB62 (3-door)
 61 1/2" w x 21 1/2" d x 35" h

#HHBFB80 (4-door)
 (4 door, 3 drawer)
 76 1/2" w x 21 1/2" d x 35" h

- Soft-closing, full extension, undermount drawer slides
 – Dovetailed, solid wood drawers
 – Soft-close doors
 – Ebony Inlays
 – Hardware (see Features & Options)
 – 1 shelf in base

Hayworth Buffet



BUFFETS & SIDEBOARDS

Melbourne Buffet



#MEBF
68" w x 18" d x 36" h
Two adjustable wood shelves
Soft-closing doors
No hardware options on buffet

Simplicity Server



#51-1101
56" w x 19" d x 36" h
– Features Walnut base
– Inlays are standard

Simplicity Curio Cabinet



#51-1001
38" w x 15" d x 60" h
Features Walnut base
Inlays are standard

35" BUFFET OPTIONS, #HYBF35

BUFFET FEATURES

- Dovetailed drawer box
- Soft close slides
- Adjustable shelf
- Reversible wine glass holder shelf
- Spice rack in drawer
- Removable Fusion Designs cutting board

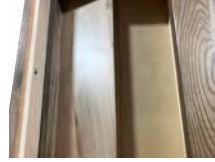

Spice Rack



Cutting Board Front



Cutting Board Back

RAISED PANEL

REVERSE PANEL

GLASS PANEL

BLOCK LEGS



#RB



#SB



#GB

TAPERED LEGS



#RT



#ST



#GT

TURNED LEGS



#RS



#SS



#GS

65" BUFFET OPTIONS, #HYBF65



Cutting Board Slot



Spice Rack



BUFFET FEATURES

- Dovetailed drawer box
- Soft close slides
- Adjustable shelf
- Reversible wine glass holder shelf
- Spice rack in drawer
- Removable Fusion Designs cutting board

RAISED PANEL

REVERSE PANEL

GLASS PANEL

BLOCK LEGS



#RB



#SB



#GB

TAPERED LEGS



#RT



#ST



#GT

TURNED LEGS



#RS



#SS



#GS



LIVING ROOM

COLLECTIONS

Imagine the compliments you'll get when your guests' eyes are drawn to your classically modern occasional table from Fusion Designs.

HONORING THE PAST DESIGNED FOR THE FUTURE.

Many furniture makers follow traditional designs primarily in the Mission or Arts and Crafts style. While we adhere to quality craftsmanship and attention to detail, our designs are innovative and imaginative.



All items shown in Oak with #100 Pebble

ARDEN

occasional collection

Introducing the Arden Collection — where sculptural form meets grounded simplicity. Crafted in a range of rich wood tones, each piece features bold, architectural arches that evoke timeless strength and contemporary grace. From the refined console to versatile side and coffee tables, this collection brings balance, beauty, and warmth to any living space.



Arden Sofa Table
#ARST
70" w x 16" d x 35" h



Arden End Table
#ARET
20" w x 20" d x 22" h



Arden Coffee Table
#AR48CT
48" w x 48" d x 18" h



Arden Coffee Table
#AR32CT
32" w x 32" d x 18" h



Arden Occasional Collection



BUNGALOW MISSION

collection

COLLECTION FEATURES

- 1" tops
- Dovetailed, maple drawers
- Premium soft-close, undermount drawer glides
- H-8 hardware

COLLECTION OPTIONS

- Distressed finish (#2D)
- Two-tone finish (#2TN)
- Hardware options (see Features & Options)



**Bungalow Mission
1 Drawer End Table**
#13-2501
21" w x 25" d x 24" h



**Bungalow Mission
26" Round End Table**
#13-2504
26" w x 26" d x 26" h

**Bungalow Mission
30" Round End Table**
#13-2505
30" w x 30" d x 26" h



**Bungalow Mission
Phone Stand**
#13-2507
19" w x 17" d x 28 1/2" h



**Bungalow Mission
Magazine Rack**
#13-2506
19 3/4" w x 13" d x 14" h



**Bungalow Mission
3 Drawer Coffee Table**
#13-2502
53" w x 25" d x 18" h

All items shown in
Quartersawn Oak with
#32 Michaels finish

All items shown in
Quartersawn Oak with
#32 Michaels finish

**Bungalow Mission
3 Drawer Sofa Table**
#13-2503
53" w x 19" d x 30" h



**Bungalow Mission
Bookcase 6 Shelves**
#13-2906
38" w x 13" d x 80" h

**Bungalow Bookcase
5 Shelves**
#13-2905
38" w x 13" d x 72" h

**Bungalow Mission
Bookcase 4 Shelves**
#13-2904
38" w x 13" d x 65" h

**Bungalow Bookcase
3 Shelves**
#13-2903
38" w x 13" d x 52" h



**Bungalow Mission
Bookcase 2 Shelves**
#13-2902
38" w x 13" d x 40" h

**Bungalow Mission
Bookcase 1 Shelves**
#13-2901
38" w x 13" d x 30" h



**Bungalow Mission
Single Door Bookcase**
#13-2907
32" w x 13 1/2" d x 60 1/2" h



**Bungalow Mission
Double Door Bookcase**
#13-2908
63" w x 13 1/2" d x 60 1/2" h

BUNGALOW MISSION

collection

CONTINUED...

All items shown in
Quartersawn Oak with
#32 Michaels finish



**Bungalow Mission
Club Chair**
#13-2301L Leather
#13-2301F Fabric
36 1/4" w x 38" d x 39" h
Stationary



**Bungalow Mission
Morris Chair**
#13-2310L Leather
#13-2310F Fabric
35" w x 37 3/4" d x 44" h
Reclines



**Bungalow Mission
Love Seat**
#13-2303L Leather
#13-2303F Fabric
60 3/4" w x 38" d x 39" h



Bungalow Mission Sofa
#13-2302L Leather
#13-2302F Fabric
84 3/4" w x 38" d x 39" h

CAMPBELL

collection

COLLECTION FEATURES

- Roundover edge on 1" thick tops
- Dovetailed, solid wood drawers
- Soft-closing, full extension, undermount drawer guides
- Soft-close doors
- N-14 knobs

COLLECTION OPTIONS

- Distressed finish (#2D)
- Two-tone finish (#2TN)



All items shown in
Brown Maple with
#49 Onvx finish



Campbell 16" End Table

#4CAET16
16" w x 24" d x 24" h

Campbell 22" End Table

#4CAET22
22" w x 24" d x 24" h

Campbell Sofa Table

#4CAST
54" w x 19" d x 30" h

Campbell Coffee Table

#4CACT
48" w x 28" d x 19" h



CASTLEBROOK

collection

COLLECTION FEATURES

- 1" tops with bread board ends
- Dovetailed, maple drawers
- Premium soft-close, undermount drawer glides
- Yellowheart wood inlays
- W-2 hardware

COLLECTION OPTIONS

- Distressed finish (#2D)
- Two-tone finish (#2TN)
- Hardware options (see Features & Options)



All items shown in
Quartersawn White Oak with
#30 Asbury finish



Castlebrook 42" Coffee Table

#4CKC42
42"w x 24"d x 18"h

Castlebrook 48" Coffee Table

(not shown)
#4CKC48
48"w x 28"d x 18"h

Castlebrook 16" End Table

#4CKE16
16"w x 26"d x 24"h

Castlebrook 23" End Table

(not shown)
#4CKE23
23"w x 26"d x 24"h

Castlebrook Sofa Table

#4CKS
54"w x 16"d x 29 1/2"h



HIGHLAND

collection



Highland Club Chair
#HL-2301L Leather
#HL-2301F Fabric
36 1/4" w x 38" d x 39" h
Stationary



Highland Morris Chair
#HL-2310L Leather
#HL-2310F Fabric
35" w x 37 3/4" d x 44" h
Reclines



Highland Love Seat
#HL-2303L Leather
#HL-2303F Fabric
60 3/4" w x 38" d x 39" h



Highland Sofa
#HL-2302L Leather
#HL-2302F Fabric
84 3/4" w x 38" d x 39" h



Highland Ottoman
#HL-2311L Leather
#HL-2311F Fabric
25" w x 15" d x 17" h

All items shown in Rustic White Oak with #120 Chalk



HUDSON

occasional collection

Introducing the Hudson Collection — a contemporary take on solid wood craftsmanship, where bold cylindrical legs and clean lines create a sculptural yet grounded presence. Designed to elevate modern living spaces, each piece brings timeless form and everyday function into perfect harmony.

Hudson Coffee Table
#HNCT
40" w x 40" d x 17" h



Hudson End Table
#HNET
18" w x 18" d x 20" h



Hudson Sofa Table
HNST
60" w x 18" d x 32" h

All items shown in Rustic White Oak with #119 Sand



JAXON

occasional collection

Meet the Jaxon Occasional Set — a modern expression of balance and simplicity, where softly rounded edges meet sculptural curves in solid wood. Available in round or square end tables, plus coordinating sofa and coffee tables, Jaxon brings effortless style and warmth to any space.

Jaxon Coffee Table

#JNCT

54" w x 30" d x 18" h



Jaxon Round End Table

#JNRDET

21" w x 21" d x 21" h



Jaxon Sofa Table

#JNST

54" w x 19" d x 30" h



Jaxon Square End Table

#JNSQET

21" w x 21" d x 21" h



MEMPHIS (CLOSED) *collection*

COLLECTION FEATURES

- 1" thick reverse-bevel tops
- Fully inset drawer & door fronts
- I-9 knobs
- Soft-close drawers & doors

COLLECTION OPTIONS

- Distressed finish (#2D)
- Two-tone finish (#2TN)

See matching Memphis pieces in the Entertainment section.



All items shown in
Quartersawn White Oak with
#30 Asbury finish

Memphis Closed End Table

#4MYET

22" w x 20" d x 24" h

Memphis Closed Coffee Table

#4MYCT

42" w x 22" d x 17 1/2" h

Memphis Closed Sofa Table

#4MYST

48" w x 16" d x 29 1/2" h



MEMPHIS (OPEN) *collection*

COLLECTION FEATURES

- 1" thick reverse-bevel tops
- Fully inset drawer fronts
- Arched top aprons
- I-9 knob
- Soft-closing, full-extension, undermount drawer guides

COLLECTION OPTIONS

- Distressed finish (#2D)
- Two-tone finish (#2TN)

See matching Memphis pieces in the Entertainment section.

All items shown in Quartersawn White Oak with #30 Asbury finish



Memphis Open Coffee Table

#4MYOCT
48" w x 28" d x 17 1/2" h

Memphis Open Sofa Table

#4MYOST
54" w x 16" d x 29 1/2" h

Memphis Open 23" End Table

#4MYOET23
23" w x 26" d x 24" h

Memphis Open 16" End Table

#4MYOET16
16" w x 26" d x 24" h



PLATTE RIVER

collection

COLLECTION FEATURES

- 1" tops
- Dovetailed, maple drawers
- Premium Side mount ball bearing glides
- SO-1 hardware

COLLECTION OPTIONS

- Distressed finish (#2D)
- Two-tone finish (#2TN)
- Hardware options
(see Features & Options)



**Platte River
Coffee Table**
#PRCT
42" w x 22" d x 17" h



**Platte River Lift
Top Coffee Table**
#PRLCT
42" w x 22" d x 17" h



**Platte River End
Table**
#PRET
20" w x 20" d x 21" h



**Platte River Sofa
Table**
#PRST
54" w x 16" d x 30" h

SIMPLICITY

collection

COLLECTION FEATURES

- 1" tops
- Dovetailed, maple drawers
- Premium soft-close, undermount drawer glides
- Features a walnut bowtie inlay in tops
- Drawer front cutout as the hardware

All items are shown in Brown Maple wood with #99 Toffee finish

COLLECTION OPTIONS

- Distressed finish (#2D)
- Two-tone finish (#2TN)



**Simplicity
Cocktail Table**
#51-2503
48" w x 26" d x 19" h



**Simplicity
Chairside Table**
#51-2501
18" w x 25" d x 24" h



**Simplicity
End Table**
#51-2502
22" w x 27" d x 23" h



**Simplicity
2 Drawer Desk**
#51-2801
50" w x 18" d x 30" h



**Simplicity
Console Table**
#51-2504
50" w x 18" d x 30" h



Tops features **Walnut Inlays**

SIMPLICITY *collection*

CONTINUED...



Simplicity Morris Chair
35" w x 37 3/4" d x 44" h
#SPMCF- Fabric
#SPMCL- Leather
Reclines



Simplicity Club Chair
42 1/2" w x 38" d x 39" h
#SPCCF- Fabric
#SPCCL- Leather
Stationary

Bottom frames feature
Walnut boards as standard



Simplicity Ottoman
25" w x 15" d x 17" h
#SPONF- Fabric
#SPONL- Leather



Simplicity Loveseat
60" w x 38" d x 39" h
#SPLSF- Fabric
#SPLSL- Leather



Simplicity Sofa
84" w x 38" d x 39" h
#SPSAF- Fabric
#SPSAL- Leather

All arms feature a
Walnut Bowtie Inlay



SOMA

collection

All items are shown in Brown Maple wood with #113 Oatmeal finish.

COLLECTION FEATURES

- 1" tops
- Dovetailed, maple drawers
- Premium soft-close, undermount drawer glides
- SO-1 hardware

COLLECTION OPTIONS

- Distressed finish (#2D)
- Two-tone finish (#2TN)
- Hardware options (see Features & Options)



Soma End Table
#SET
24" w x 28" d x 24" h



Soma Sofa Table
#SST
64" w x 16" d x 29 1/2" h



Soma Console
#SCT
72" w x 14" d x 24" h



Soma Coffee Table
#SCFT
48" w x 18" d x 28" h

ENTERTAINMENT & MEDIA CONSOLE

COLLECTIONS

Whatever your available space, whatever feature you desire, whatever persona you want to add to your room's decor, Fusion Designs offers a media center that's adaptable to your needs.

PERFECT FIT AND FUNCTION.

All of our beautiful cabinets, hutches, and towers are crafted to provide an aesthetically pleasing look and long-lasting use.

Media Consoles

MEMPHIS

COLLECTION FEATURES

- Dovetailed solid wood drawers
- Soft-close doors & drawers
- I-9 hardware

Media Unit Features

- 2 CD/DVD accessible drawers
- 1 adjustable shelf behind each door
- KV ball bearing, full-extension slides
- Smoked glass in doors

COLLECTION OPTIONS

- Hardware Options
(see Features & Options page)

See matching Memphis pieces in the Living Room section.

All items shown in Quartersawn White Oak with #32 Michaels Cherry finish

15"	18.625"	10.375"	
7.25"	30.25"		
18" Model Interior Depth 15.5"			

15"	18.625"	10"	
7.25"	24.25"		
18" Model Interior Depth 15.5"			

15"	18.625"	
7.25"	38.5"	
18" Model Interior Depth 15.5"		



**Memphis 49"
Media Console**
#4MYTVS49
49" w x 18" d x 29 1/2" h

**Memphis 60"
Media Console**
#4MYTVS60
60" w x 18" d x 29 1/2" h

**Memphis 72"
Media Console**
#4MYTVS72
72" w x 18" d x 29 1/2" h

PLATTE RIVER

COLLECTION FEATURES

- Constructed using solid wood
- Dovetailed, solid wood drawer boxes
- Soft closing doors
- BH-2 Knobs, SO-1 Pulls hardware
- 1 shelf behind each door

COLLECTION OPTIONS

- Hardware options
(see Features & Options)



Platte River 60" Console

#PRTV60

60" w x 21" d x 32" h

Platte River 72" Console

#PRTV72

72" w x 21" d x 32" h

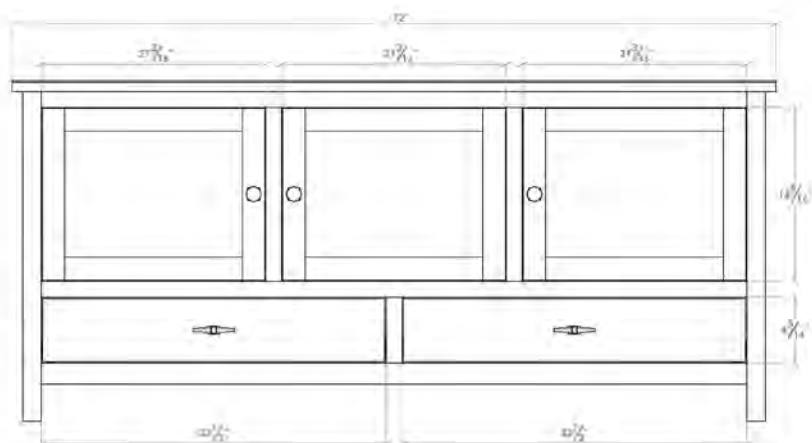
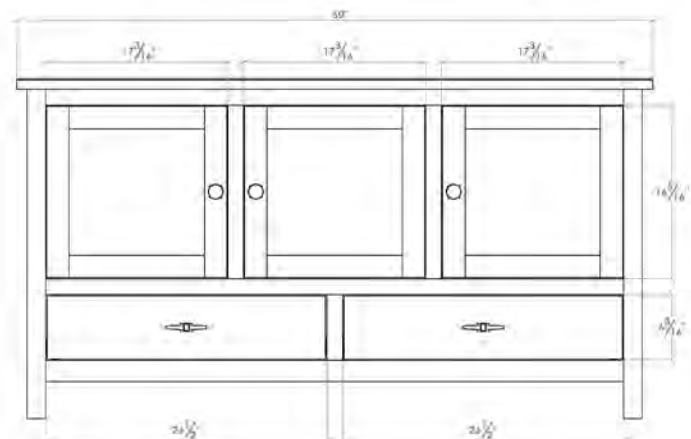

SOMA

All items are shown in Brown Maple wood with #113 Oatmeal finish.

COLLECTION FEATURES

- Constructed using solid wood
- Dovetailed, solid wood drawer boxes
- Soft closing doors
- SO-1 Knob hardware
- 1 shelf behind each door

COLLECTION OPTIONS

- Hardware options
(see Features & Options)



Soma Open 60" Console
#SOET60
60" w x 18" d x 30" h

Soma Open 72" Console
#SOET72
72" w x 18" d x 30" h

Soma Closed 60" Console
#SCET60
60" w x 18" d x 30" h

Soma Closed 72" Console
#SCET72
72" w x 18" d x 30" h

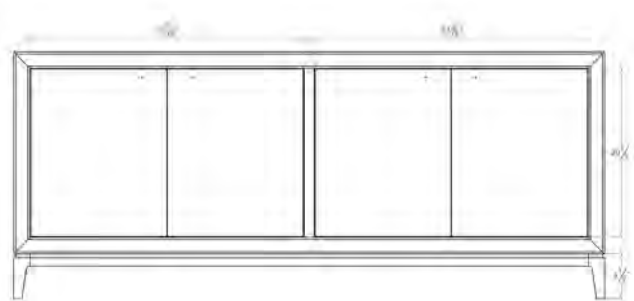
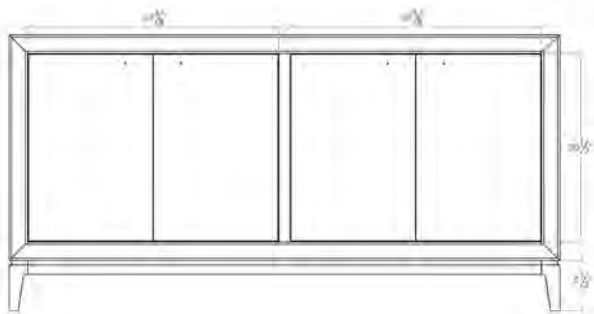
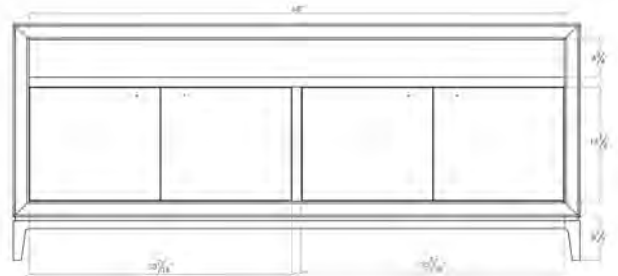
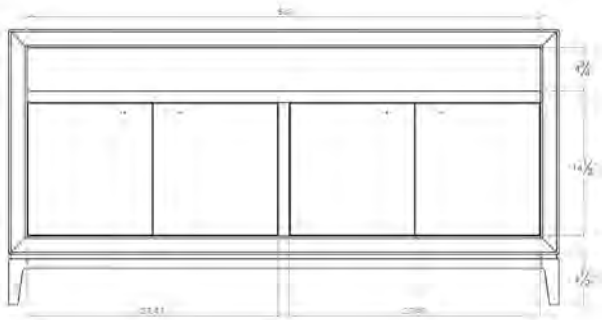

OFFICE

COLLECTIONS

Our office furniture reflects the growing enthusiasm in a crafted furniture experience for the home. With talented artisans using time-honored techniques passed down through generations, these are timeless pieces that will never pass out of style.

FURNITURE MEANT TO BE ENJOYED FOR GENERATIONS.

OFFICE COLLECTIONS

Livonia Channel Back Upholstered Chair
#LVACCF
25" w x 20" d x 37" h
– Fabric #LVACCF
– Leather #LVACCL



Clyde Desk Chair
20 1/2" w x 24 1/2" d x 35" h
– Fabric #CYDCF
– Leather #CYDCL



Renley Office Chair
#LVACCF
25" w x 26 1/2" d x Adjustable Height
– Fabric #RYACF
– Leather #RYACL

Platte River

COLLECTION FEATURES

- Constructed using solid wood
- Dovetailed, solid wood drawer boxes
- Sidemounted slides

Executive Desk Features

- Electrical/USB port
- SO-1 hardware

Bookshelf Features

- Adjustable shelves

COLLECTION OPTIONS

- Hardware Options
(see Features & Options page)

*Not available as custom

All items are shown in Brown Maple wood with #113 Oatmeal finish.

Power Port/USB



Platte River Executive Desk
#PRDK66
66"W x 24"D x 30"H



Platte River Writing Desk
#PRDK48
48"W x 24"D x 30"H



Platte River File Cabinet
#PRFC2D
19.5"W x 24"D x 30"H



Platte River 72\" Bookshelf
#PRBK72, 4 shelves
36"W x 14"D x 72"H

OFFICE COLLECTIONS

Platte River

Platte River 30" Bookshelf
#PRBK30, 1 shelf
36"W x 14"D x 30"H



Platte River 36" Bookshelf
#PRBK36, 2 shelves
36"W x 14"D x 36"H



Platte River 48" Bookshelf
#PRBK48, 3 shelves
36"W x 14"D x 48"H



Platte River 60" Bookshelf
#PRBK60, 3 shelves
36"W x 14"D x 60"H



Platte River

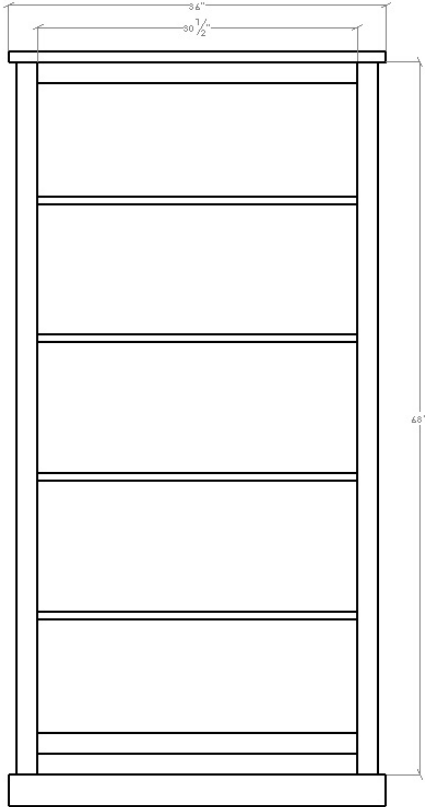

Platte River 72" Bookshelf
#PRBK72, 4 shelves
36"W x 14"D x 72"H

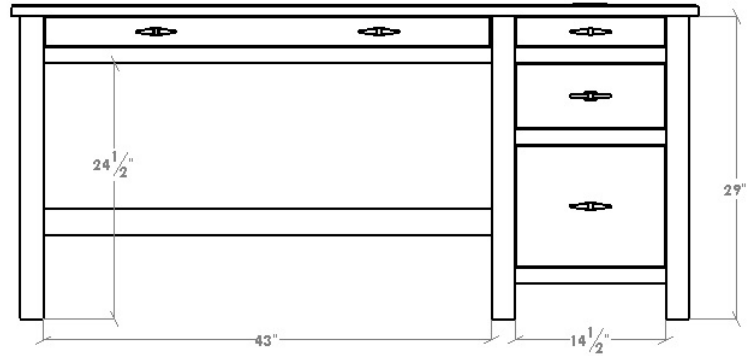

Platte River Executive Desk
#PRDK66
66"W x 24"D x 30"H

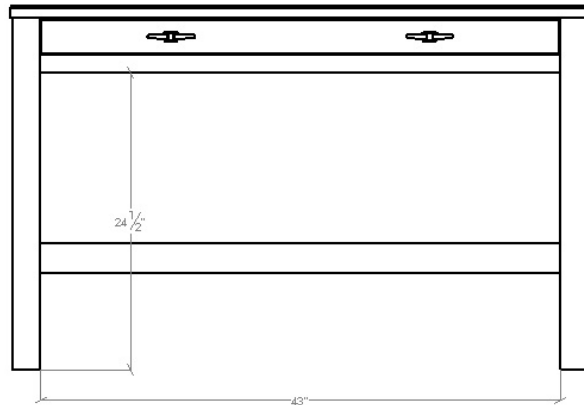

Platte River Writing Desk
#PRDK48
48"W x 24"D x 30"H

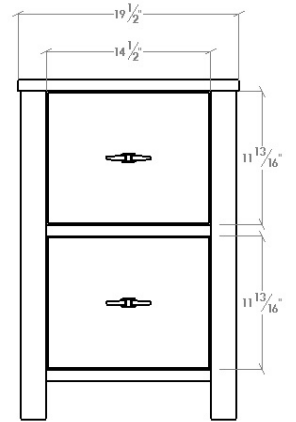

Platte River File Cabinet
#PRFC2D
19.5"W x 24"D x 30"H

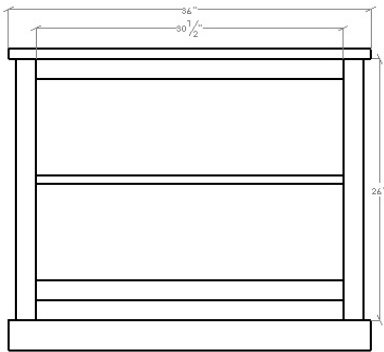

Platte River 30" Bookshelf
#PRBK30, 1 shelf
36"W x 14"D x 30"H

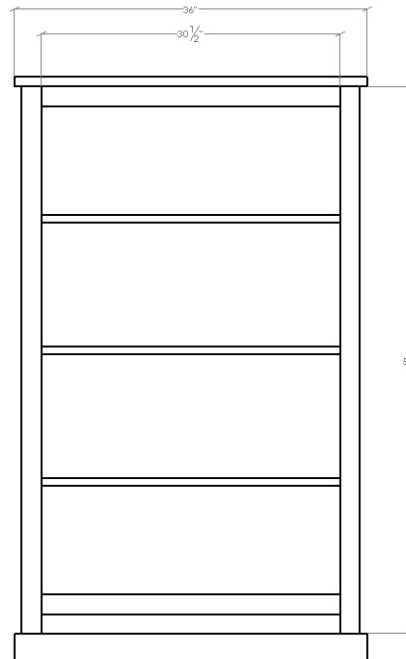

Platte River 60" Bookshelf
#PRBK60, 3 shelves
36"W x 14"D x 60"H

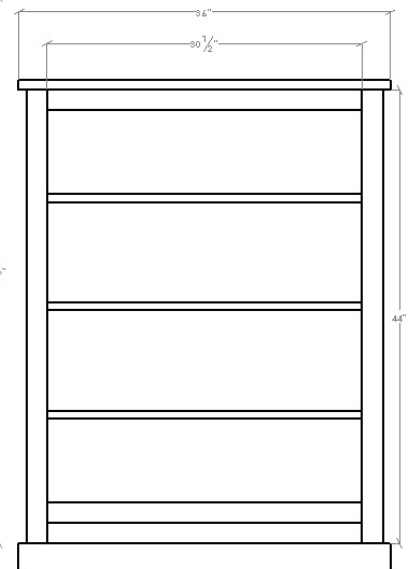

Platte River 48" Bookshelf
#PRBK48, 3 shelves
36"W x 14"D x 48"H

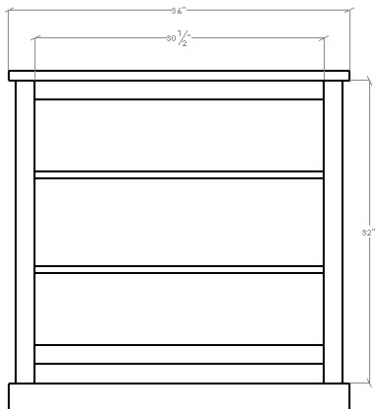

Platte River 36" Bookshelf
#PRBK36, 2 shelves
36"W x 14"D x 36"H

OFFICE COLLECTIONS

Simplicity

COLLECTION FEATURES

- Constructed using solid wood
- Dovetailed, solid wood drawer boxes
- Walnut bowtie inlays
- Side mount slides are used for superior strength
- Locks on file drawers
- USB features
- Electrical port on desk
- Flip down keyboard drawers
- Docking power stations
- Finished back panels
- Adjustable shelves in bookshelves
- Select pieces feature walnut bases as a standard

*Not available as custom



**Simplicity Desk
w/ 2 Drawers**
#51-2801

50" w x 18" d x 30" h

Shown in Brown Maple wood
with #99 Toffee finish.



Simplicity 66" Drawer Desk
#SPDK66DT

66" w x 30" d x 30" h

Shown in Brown Maple wood
with #103 Dew finish



Flip Down Keyboard Drawers



**Simplicity Adjustable
60" Desk**
#SPDK60A

60" w x 24" d x 24 1/2 - 50" h
Features an electronic control module
with 4 preset height adjustments and
a plug in power strip



Features **Bowtie Inlays**
as standard



Simplicity File Cabinet

#SPFCL2, 2-Drawer
38" w x 21" d x 30" h

#SPFC2D, 2-Drawer
17" w x 25" d x 30" h

#SPFC3D, 3-Drawer
17" w x 25" d x 41 1/4" h

#SPFC3D, 3-Drawer
17" w x 25" d x 52 1/2" h

Shown in Brown Maple wood
with #103 Dew finish

Walnut base
is standard

OFFICE COLLECTIONS

Simplicity

- Simplicity Bookshelf**
- #SPBK30, 1 Shelf 40" w x 14 1/2" d x 30" h
 - #SPBK36, 2 Shelves 40" w x 14 1/2" d x 36" h
 - #SPBK48, 3 Shelves 40" w x 14 1/2" d x 48" h
 - #SPBK60, 4 Shelves 40" w x 14 1/2" d x 60" d
 - #SPBK78, 5 Shelves 40" w x 14 1/2" d x 78" h
 - #SPBK84, 6 Shelves 40" w x 14 1/2" d x 84" h

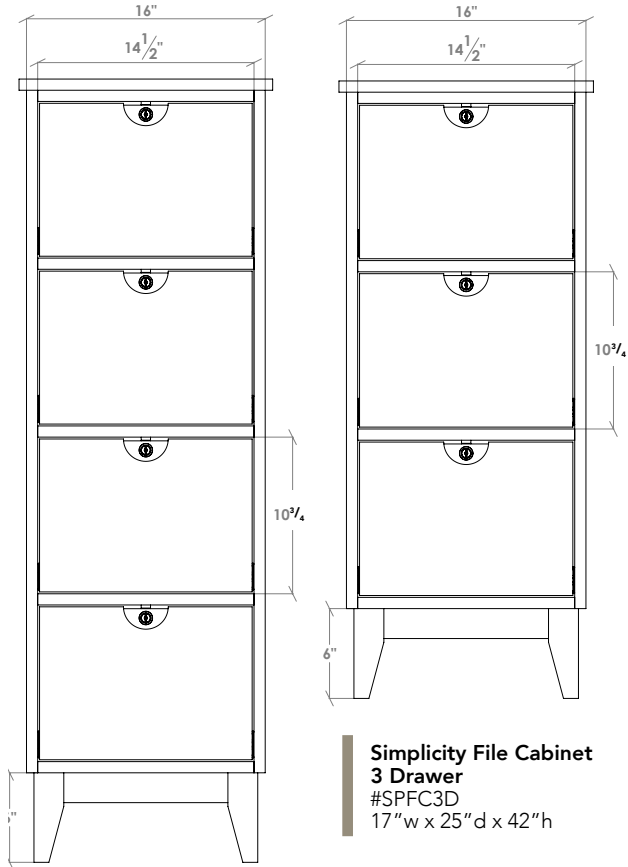

**Simplicity File Cabinet
3 Drawer**
#SPFC3D
17" w x 25" d x 42" h

**Simplicity File Cabinet
4 Drawer**
#SPFC4D
17" w x 25" d x 53" h

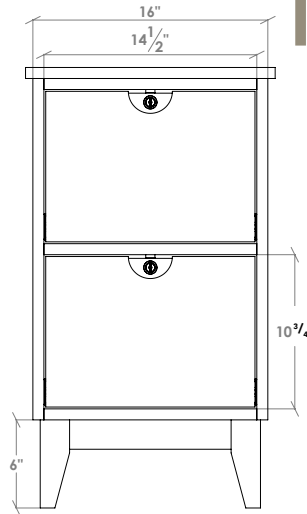

**Simplicity File Cabinet
2 Drawer**
#SPFC2D
17" w x 25" d x 30 1/2" h

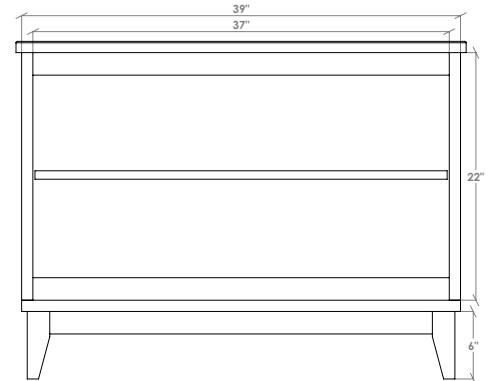

**Simplicity File Cabinet
2 Drawer**
#SPFCL2
38" w x 21" d x 30 1/2" h

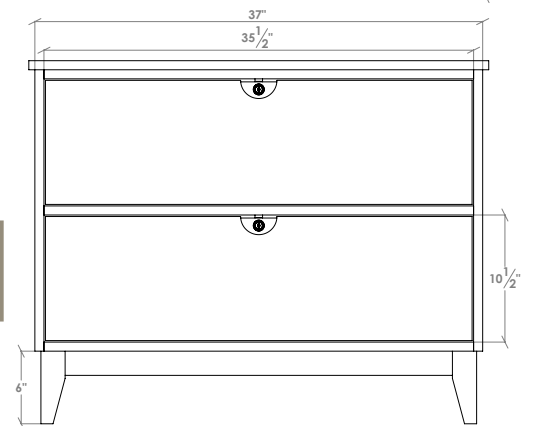

Simplicity 66" Media Drawer Desk
#SPDK66MD
66" w x 30" d x 30" h

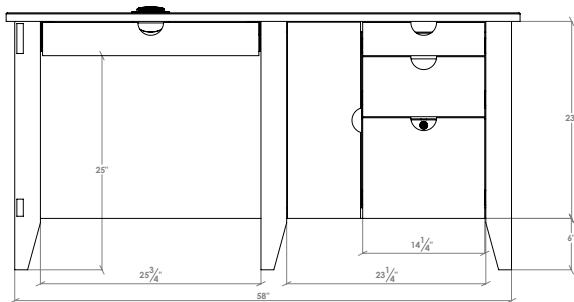

Simplicity 60" Drawer Desk
#SPDK60DT
60" w x 30" d x 30" h

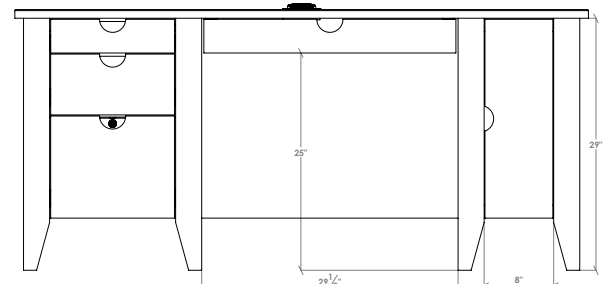

Simplicity 72" Drawer Desk
#SPDK72DT
72" w x 30" d x 30" h

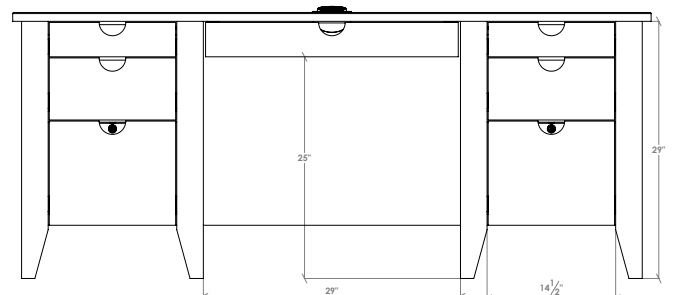





BEDROOM

OPTIONS

Romp in bed with the kids. Sleep in on Sunday morning. Beds made by Fusion Designs are rugged and solid, yet cradle you in restful comfort. While other companies say they still make their furnishings mostly by hand...

**WE ALWAYS WILL.
THAT'S OUR
PLEDGE TO YOU.**

High-grade hardwoods and proven finishes mean that you can trust your bedroom furniture will last for many years. In fact, we guarantee it!

ADDISON *Bedroom Collection*

COLLECTION FEATURES

- Constructed with mortise and tenon joints
- Cast dovetailed brackets support mattress
- Hardware not available on other collections
- Dovetailed drawers
- Soft-close full access drawers
- All nightstands feature USB A & C Power

COLLECTION OPTIONS

- Distressed finish (#2D)
- Hardware Options - see hardware page in Features & Options section
- Underbed Storage Options
- See upholstery book for fabric and leather choices



**Hardware not available on other collections*



Addison 3-Drawer Nightstand

#ADNS
26" w x 18 3/4" d x 30" h
USB A & C Power



Addison 1-Drawer Nightstand

#ADNS1
26" w x 18 3/4" d x 30" h
USB A & C Power



Shown in Brown Maple with #115 Harbor Gray Finish



**Addison
5-Drawer Chest**
#ADCD
41" w x 22" d x 53 1/4" h



Addison Mirror
#ADMR
45 3/4" w x 38 1/4" h

**Addison
6-Drawer Dresser**
#ADDR
65" w x 22" d x 33 1/2" h

Addison Bed
Headboard 55" h
Footboard 24" h
#CADKB Cal King 75 7/8" w
#ADKB King 78 7/8" w
#ADQB Queen 62 7/8" w
#ADFB Full 56 7/8" w



Addison Panel Bed
Headboard 55" h
Footboard 24" h
#CADPKB Cal King 75 7/8" w
#ADPKB King 78 7/8" w
#ADPQB Queen 62 7/8" w
#ADPFB Full 56 7/8" w

* see underbed storage options
on line drawings page.

ADDISON

BEDROOM COLLECTION SPECIFICATIONS

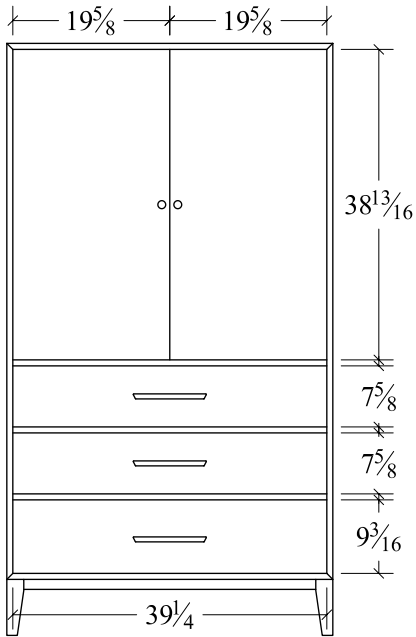

Armoire (ADAR)
3 drawer, 2 door
41w x 22d x 74 1/4h

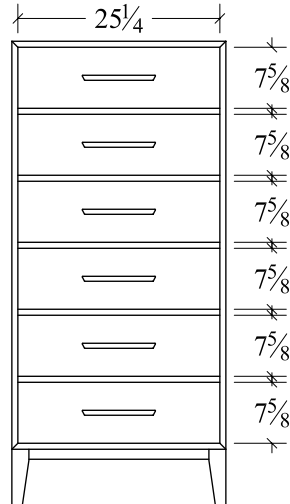

Lingerie (ADLC)
6 drawer
27w x 22d x 58 1/4h

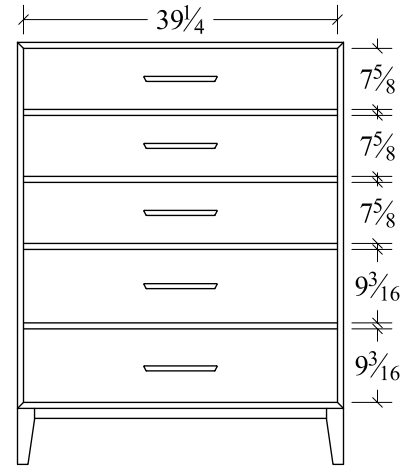

Chest (ADCD)
5 drawer
41w x 22d x 53 1/4h

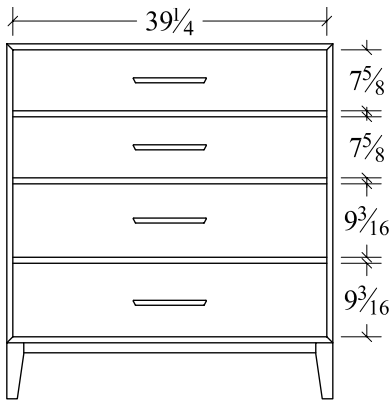

Chest (AD4CD)
4 drawer
41w x 22d x 44 5/8h

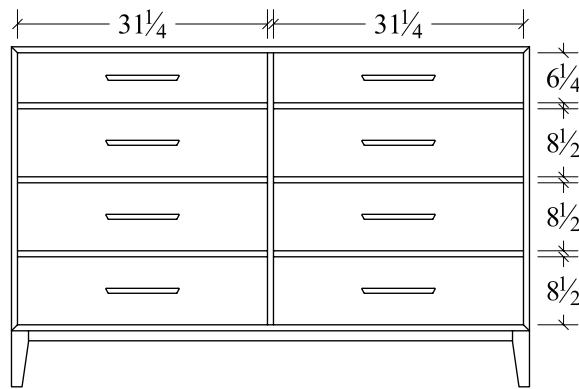

Dresser (AD8DR65)
8 drawer
65w x 22d x 43h

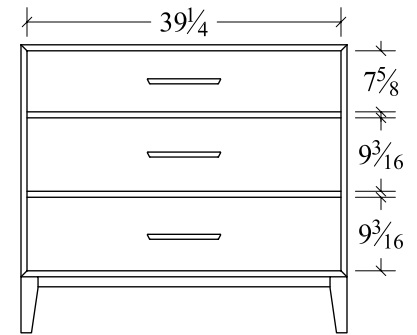

Chest (AD3CD)
3 drawer
41w x 22d x 36 1/4h

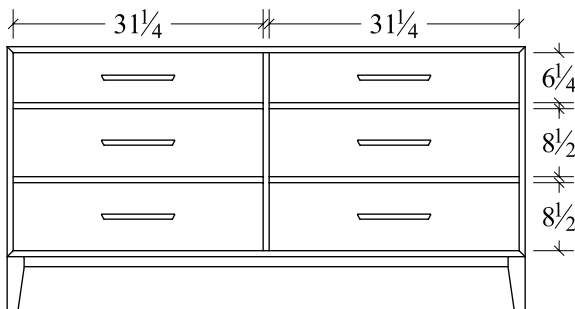

Dresser (ADDR)
6 drawer
65w x 22d x 33 1/2h

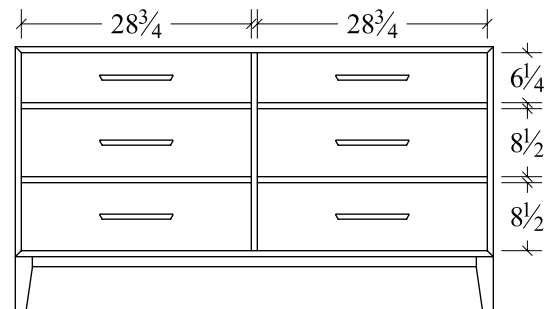

Dresser (AD6DR60)
6 drawer
60w x 22d x 33 1/2h

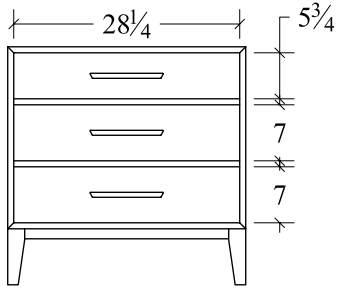

Night Stand (ADNS30)
3 drawer
30w x 18 3/4d x 30h

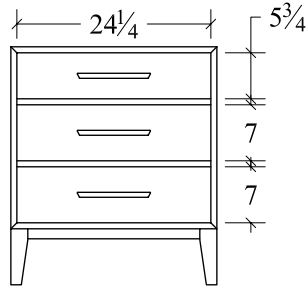

Night Stand (ADNS)
3 drawer
26w x 18 3/4d x 30h

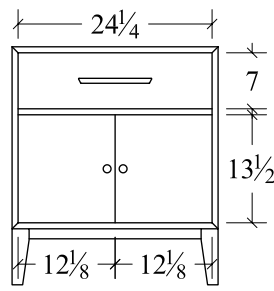

Night Stand (ADNS11)
1 drawer, 2 door
26w x 18 3/4d x 30h

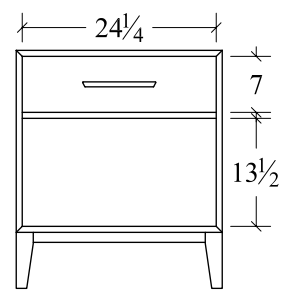

Night Stand (ADNS1)
1 drawer
26w x 18 3/4d x 30h

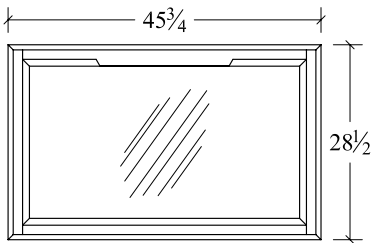

Mirror (ADMR8)
45 3/4w x 28 1/2h

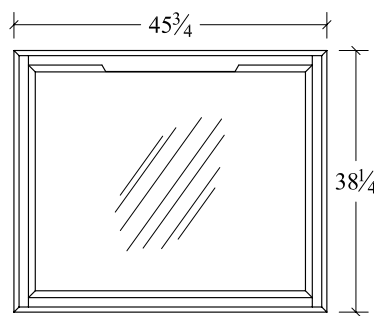

Mirror (ADMR)
45 3/4w x 38 1/4h

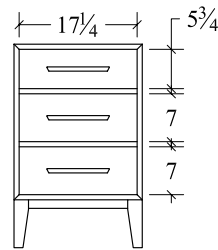

Night Stand (ADNS19)
3 drawer
16w x 18 3/4d x 30h

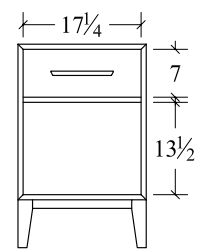

Night Stand (ADNS191)
1 drawer
19w x 18 3/4d x 30h

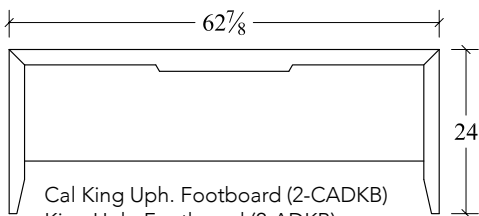

Cal King Uph. Footboard (2-CADKB)
King Uph. Footboard (2-ADKB)
Queen Uph. Footboard (2-ADQB)
Full Uph. Footboard (2-ADFB)
Twin Uph. Footboard (2-ADTB)

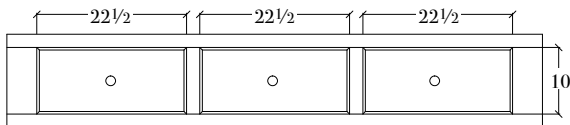

Storage Rail
3 drawer
14h

Cal King (3-2CADKBRS)
King (3-2ADKBRS)
Queen (3-2ADQBRS)
Full (3-2ADFBRS)
Twin (3-2ADTBRS)

*Upholstered and Panel Bed are the same dimensions

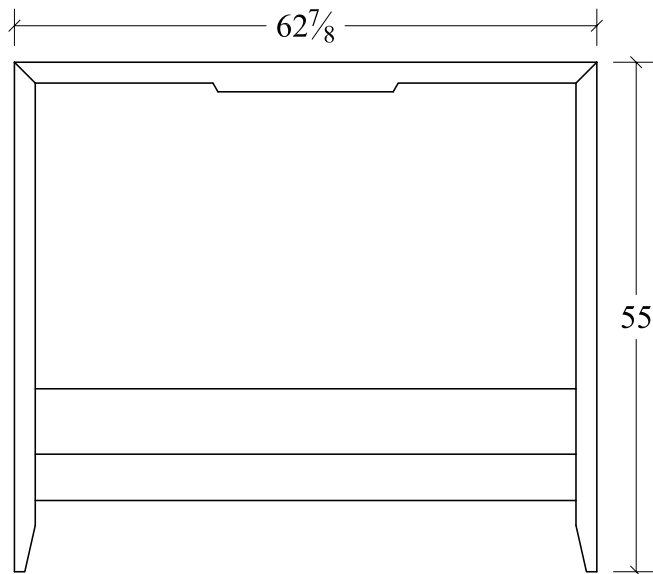

Cal King Uph. Headboard (1-CADKB)
King Uph. Headboard (1-ADKB)
Queen Uph. Headboard (1-ADQB)
Full Uph. Headboard (1-ADFB)
Twin Uph. Headboard (1-ADTB)

ARCOLA *Bedroom Collection*

COLLECTION FEATURES

- Constructed with mortise and tenon joints
- Cast dovetailed brackets support mattress
- Hardware not available on other collections
- Dovetailed drawers
- Soft-close full access drawers
- Mirror has a bevel cut edge
- Case goods are fully framed, solid wood
- Case goods feature 1" solid top
- Armoire features 2 solid hardwood, adjustable shelves
- Chest features a cedar-lined bottom drawer
- RE Hardware
- All nightstands feature USB A & C Power

COLLECTION OPTIONS

- Hardware Options - see hardware page in Features & Options section
- Underbed Storage Options
- See upholstery book for fabric and leather choices
- Three plug power strip. Case goods available with touch switch LED night light (#LEDN)
- Night Stand available with sliding top, hidden compartment, lock and three plug power strip (#STP)



Arcola Panel Bed

Headboard - 54" h

Footboard - 18" h

#CACPKB - Cal. King: 75 1/2" w x 92" d

#ACPKB - King: 79 1/2" w x 88" d

#ACPQB - Queen: 63 1/2" w x 88" d

#ACPFB - Full: 57 1/2" w x 84" d

#ACPTB - Twin: 42 1/2" w x 84" d

Arcola 3 Drawer Nightstand

#ACNS332

32" w x 17" d x 26 1/4" h

USB A & C Power



Arcola Bench

#ACB

64" w x 16" d x 18" h



Shown in Brown Maple with #124 Soft Brown

ARCOLA *Bedroom Collection*



Arcola Bed

Headboard - 54" h

Footboard - 18" h

#CACUKB - Cal. King: 75 1/2" w x 92" d

#ACUKB - King: 79 1/2" w x 88" d

#ACUQB - Queen: 63 1/2" w x 88" d

#ACUFB - Full: 57 1/2" w x 84" d

#ACUTB - Twin: 42 1/2" w x 84" d

Arcola 5 Drawer Chest

#ACCD

40" w x 18 3/4" d x 55" h



Arcola 9 Drawer Dresser

#ACDR9

68" w x 18 3/4" d x 34 1/2" h



Jewelry tray in dresser Arcola Dresser



ARCOLA

BEDROOM COLLECTION SPECIFICATIONS

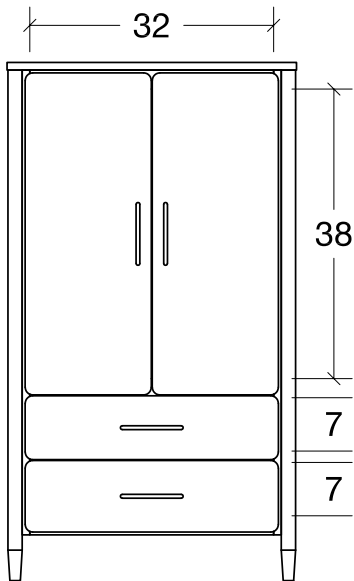

Armoire (ACAR)
2 Drawer
2 Door
38w x 22d x 68h

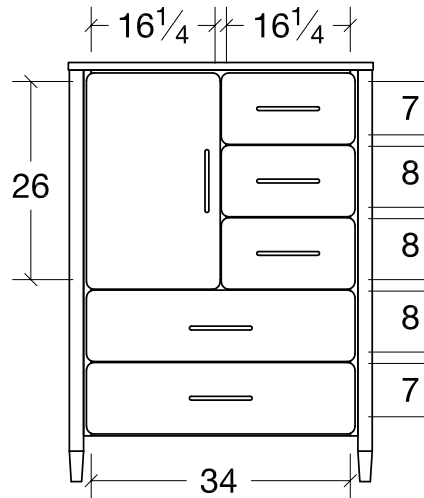

Chest (ACDRC)
5 Drawer
1 Door
40w x 18³/₄d x 55h

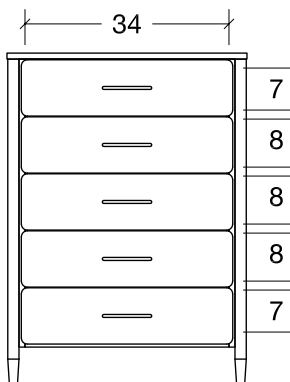

Chest (ACCD)
5 Drawer
40w x 18³/₄d x 55h

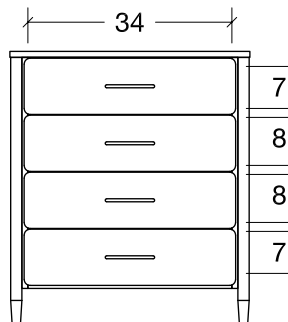

Chest (ACCD4)
4 Drawer
40w x 18³/₄d x 45¹/₂h

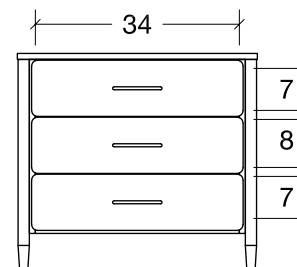

Chest (ACCD3)
3 Drawer
40w x 18³/₄d x 36h

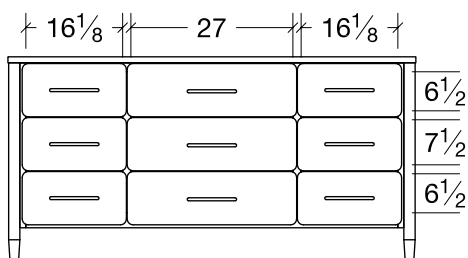

Dresser (ACDR9)
9 Drawer
68w x 18³/₄d x 34¹/₂h

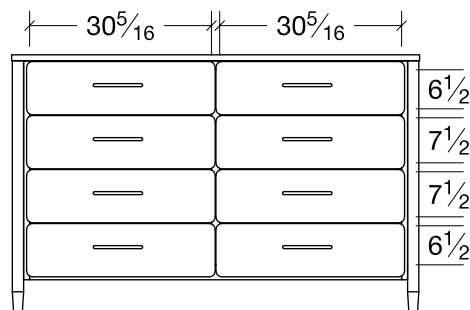

Dresser (ACDR8)
8 Drawer
68w x 18³/₄d x 43¹/₂h

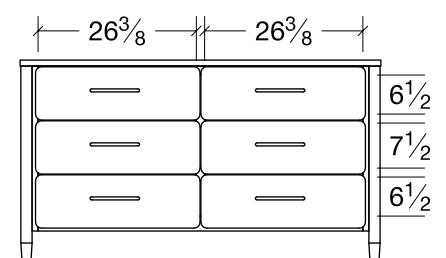

Dresser (ACDR)
6 Drawer
60w x 18³/₄d x 34¹/₂h

ARCOLA

BEDROOM COLLECTION SPECIFICATIONS

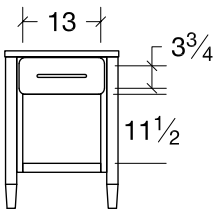

Nightstand (ACNS119)
1 Drawer
19w x 17d x 26 1/4h

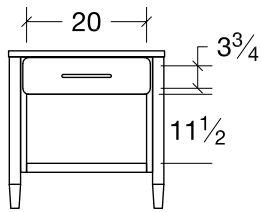

Nightstand (ACNS1)
1 Drawer
26w x 17d x 26 1/4h

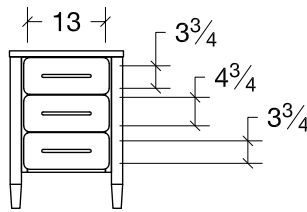

Nightstand (ACNS319)
3 Drawer
19w x 17d x 26 1/4h

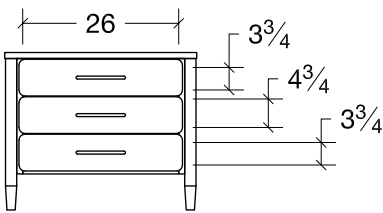

Nightstand (ACNS332)
3 Drawer
32w x 17d x 26 1/4h

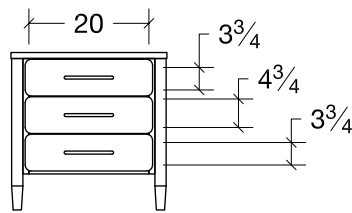

Nightstand (ACNS3)
3 Drawer
26w x 17d x 26 1/4h

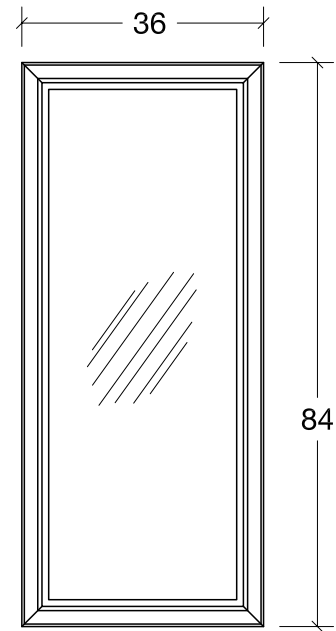

Mirror (ACFM)
36w x 84h

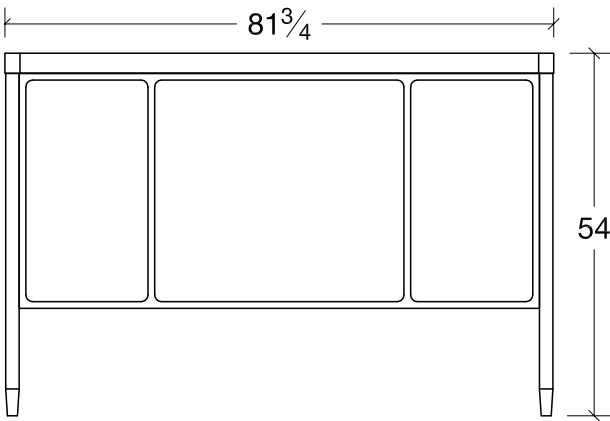

King Panel Headboard
81 3/4w x 54h

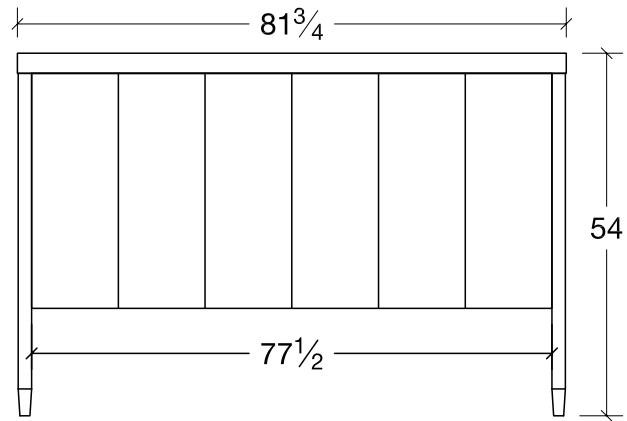

King Fabric Headboard
81 3/4w x 54h

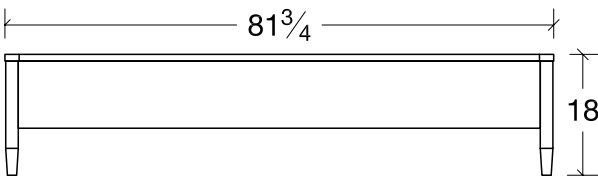

King Footboard
81 3/4w x 18h

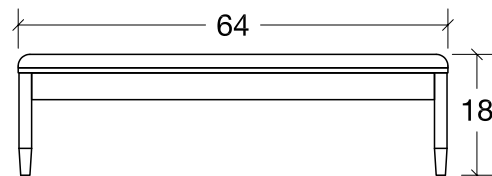

Bench (ACB)
64w x 16d x 18h

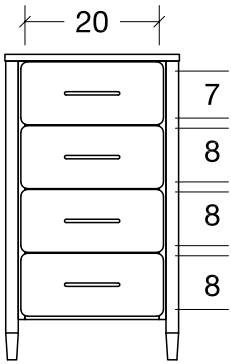

Chest (ACLC)
4 Drawer
26w x 17d x 45½h

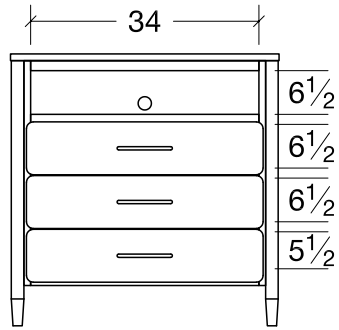

Media Chest (ACMC)
3 Drawer
40w x 18¾d x 40½h

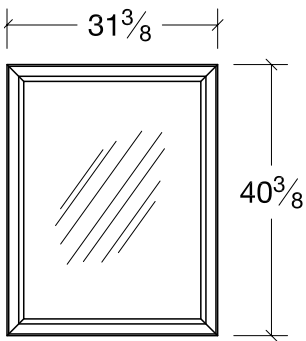

Mirror (ACMR31)
31½w x 40½h

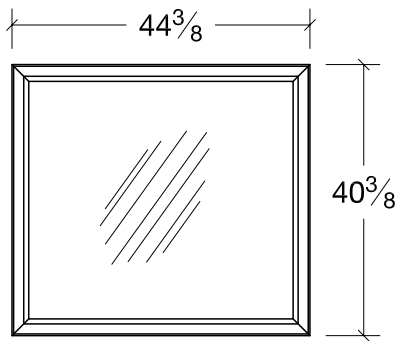

Mirror (ACMR44)
44½w x 40½h

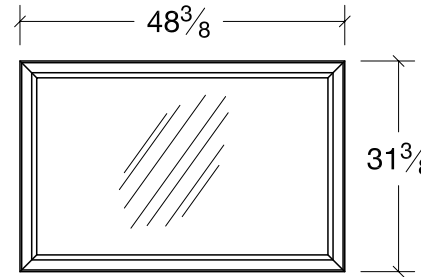

Mirror (ACMR48)
48½w x 31½h



Shown in Brown Maple with #124 Soft Brown



THE OLIVIAN

BRITON *Bedroom Collection*

COLLECTION FEATURES

- Constructed with mortise and tenon joints
- Metal brackets support mattress
- Dovetailed, solid wood drawers
- Full access, side mounted, ball-bearing guides
- Z-3 knobs for hardware
- All nightstands feature USB A & C Power

COLLECTION OPTIONS

- Hardware options (see Features & Options page)
- Underbed storage available



Briton Bed

Popular Sizes:

Headboard 50" h
Footboard 23" h

#BNQB Queen 63 1/2" w x 88" d

#BNKB King 79 1/2" w x 88" d

#CBNKB Cal King 75 1/2" w x 92" d

Briton Bed w/Storage Footboard

#BNKBSF King

#BNQBSF Queen

#CBNBSF Cal King



Briton Dresser

#BNDR

60" w x 21 1/2" d x 37 1/2" h

Briton Mirror

#BNMR

43 x 39





Briton Chest
#BNCD
37" w x 51" h x 21 1/2" d



Briton 1 Drawer Nightstand
#BNNS1
23" w x 27 3/4" h x 17" d
USB A & C Power



Briton 3 Drawer Nightstand
#BNNS3
23" w x 27 3/4" h x 17" d
USB A & C Power



Shown in Brown Maple with #65 Chocolate Finish

BRITON BEDROOM COLLECTION SPECIFICATIONS

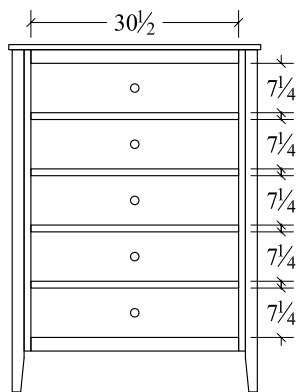

Chest (BNCD)
5 drawer
37w x 21 1/2d x 51h

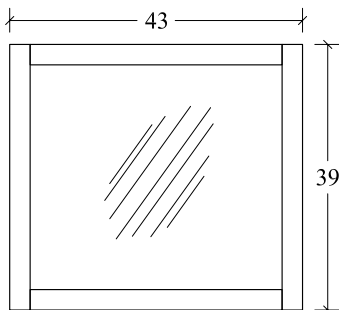

Mirror (BNMR)
43w x 39h

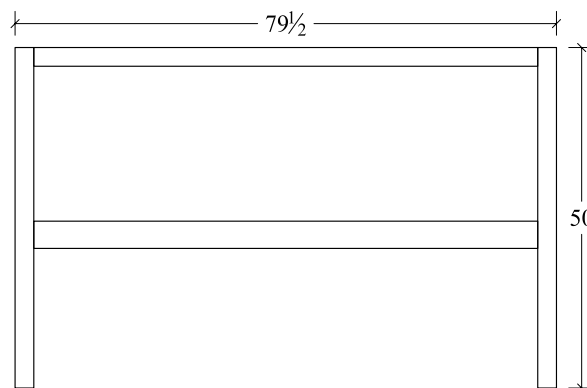

King Headboard (1-BNKB) 79 1/2w x 50h
Queen Headboard (1-BNQB) 63 1/2w x 50h
Full Headboard (1-BNFB) 57 1/2w x 50h
Twin Headboard (1-BNTB) 42 1/2w x 50h
Cal King Headboard (1-CBNKB) 75 1/2w x 50h

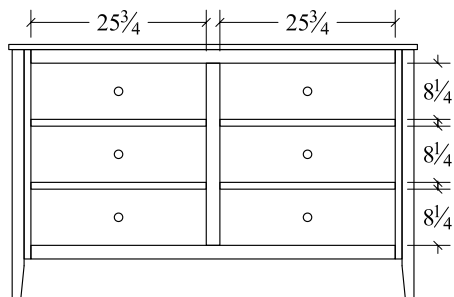

Dresser (BNDR)
6 drawer
60w x 21 1/2d x 37 1/2h

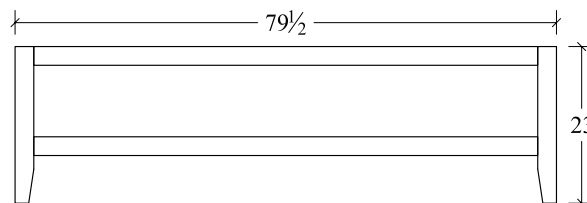

King Footboard (2-BNKB) 79 1/2w x 23h
Queen Footboard (2-BNQB) 63 1/2w x 23h
Full Footboard (2-BNFB) 57 1/2w x 23h
Twin Footboard (2-BNTB) 42 1/2w x 23h
Cal King Footboard (2-CBNKB) 75 1/2w x 23h

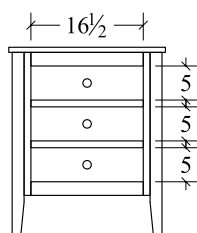

Nightstand (BNNS3)
3 drawer
23w x 17d x 27 3/4h

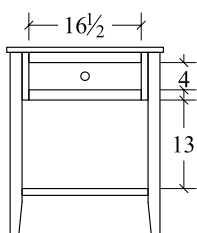

Nightstand (BNNS1)
1 drawer, 1 opening
23w x 17d x 27 3/4h

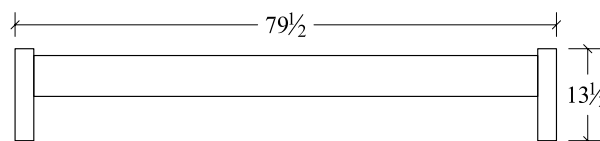

King Low Footboard (2-BNKBLFB) 79 1/2w x 13 1/2h
Queen Low Footboard (2-BNQBLFB) 63 1/2w x 13 1/2h
Full Low Footboard (2-BNFLFB) 57 1/2w x 13 1/2h
Twin Low Footboard (2-BNTBLFB) 42 1/2w x 13 1/2h
Cal King Low Footboard (2-CBNKBLFB) 75 1/2w x 13 1/2h

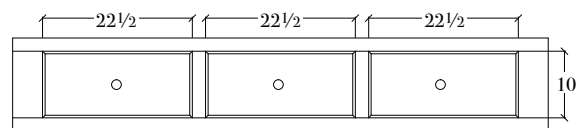

Storage Rail
3 drawer
14h
Cal King (3-2CBNKBS)
King (3-2BNKBS)
Queen (3-2BNQBS)
Full (3-2BNFBS)
Twin (3-2BNTBS)

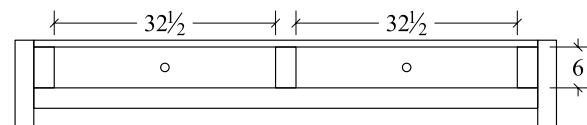

King Storage Footboard (2-BNKBSF) 79 1/2w x 13h
Queen Storage Footboard (2-BNQBSF) 63 1/2w x 13h
Full Storage Footboard (2-BNFBSF) 57 1/2w x 13h
Twin Storage Footboard (2-BNTBSF) 42 1/2w x 13h
Cal King Storage Footboard (2-CBNKBSF) 75 1/2w x 13h

the Briton

Drawing Scale: 1/2" = 1'



BUNGALOW *Bedroom Collection*

COLLECTION FEATURES

- Mirrors have bevel cut edges
- Constructed with mortise and tenon joints
- Dovetailed, solid Cedar wood drawers
- Soft-closing, full access, undermount drawer guides
- Measurements are to the tops of the backsplash on the case goods
- All nightstands feature USB A & C Power

COLLECTION OPTIONS

- Low footboard option
- Hardware options (see Features & Options page)
- Underbed storage options

NOTE: This collection not available with nightlight or docking station options

*Bungalow cannot have sliding top option

Inspired by the traditions of Mission style, the clean, vertical lines and flat planes of the timeless Bungalow Collection are crafted from red, quarter-sawn oak, with a finish that uses the natural grain of the wood as a decorative element. Highlights include cedar drawer boxes with English dovetail construction, handsome hardware in a rustic finish, and a spindle bed and nightstand that impart a light and airy look crafted to last for generations. Coordinating upholstered furniture is also available.



Bungalow 1-Drawer Nightstand
#13-1601
21" w x 20" d x 31" h
USB A & C Power



Shown in Quartersawn Oak with #32 Michaels finish

Bungalow Panel Bed

Popular Sizes:

- Twin Panel Bed
#13-1502T 46" x 48"
- Full Panel Bed
#13-1502F 64" x 48"
- Queen Panel Bed
#13-1502Q 72" x 48"
- King Panel Bed
#13-1502K 92" x 48"
- Cal King Panel Bed
#13-1502C 84" x 48"



Bungalow Panel Bed w/ Low Footboard

Popular Sizes:

- Twin Panel Bed
#13-1502TLF 46" x 48"
- Full Panel Bed
#13-1502FLF 64" x 48"
- Queen Panel Bed
#13-1502QLF 72" x 48"
- King Panel Bed
#13-1502KLF 92" x 48"
- Cal King Panel Bed
#13-1502CLF 84" x 48"

Bungalow Spindle Bed

Popular Sizes:

- Twin Spindle Bed
#13-1501T 46" x 48"
- Full Spindle Bed
#13-1501F 64" x 48"
- Queen Spindle Bed
#13-1501Q 70" x 48"
- King Spindle Bed
#13-1501K 86" x 48"
- Cal King Spindle Bed
#13-1501C 82" x 48"



Bungalow Spindle Bed w/ Low Footboard

Popular Sizes:

- Twin Spindle Bed
#13-1501TLF 46" x 48"
- Full Spindle Bed
#13-1501FLF 64" x 48"
- Queen Spindle Bed
#13-1501QLF 70" x 48"
- King Spindle Bed
#13-1501KLF 86" x 48"
- Cal King Spindle Bed
#13-1501CLF 82" x 48"

* see underbed storage options on line drawings page.

BUNGALOW *Bedroom Collection*

CONTINUED...



Pull-Out Tray

Bungalow 3 Drawer Nightstand
#13-1602
24"w x 20 1/2"d x 31"h
USB A & C Power

Pull-Out Tray



Bungalow 3 Drawer Chest
#13-1801
34"w x 20 1/2"d x 33"h



Bungalow 9 Drawer Mule Chest
#13-1804
67"w x 20 1/2"d x 38"h



Solid Cedar Drawer Boxes

Bungalow 7 Drawer Dresser
#13-1701
65"w x 20 1/2"d x 35 1/2"h





Bungalow Gentleman's Chest
#13-1805
41" w x 20 1/2" d x 54" h

*1 adjustable shelf behind door



Bungalow 8 Drawer Chest
#13-1802
41" w x 20 1/2" d x 54" h

Bungalow Mule Mirror
#13-2002
61" w x 29" h



Bungalow Mule Chest
#13-1803
67" w x 20 1/2" d x 46 1/2" h

BUNGALOW

BEDROOM COLLECTION SPECIFICATIONS

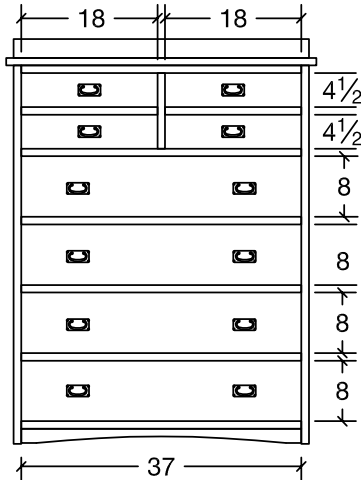

13-1802
8 Drawer Chest
8 Drawers
41w x 20 1/2d x 54h

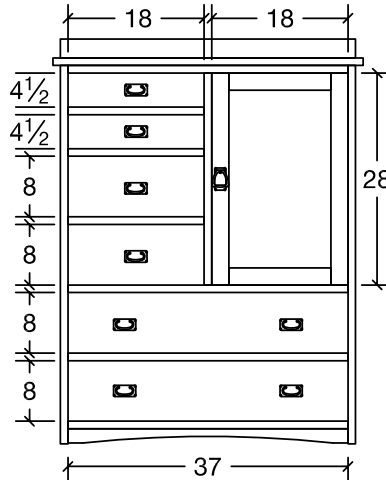

13-1805
Gentlemans Chest
6 Drawers, 1 Door
41w x 20 1/2d x 54h

*1 adjustable shelf behind door

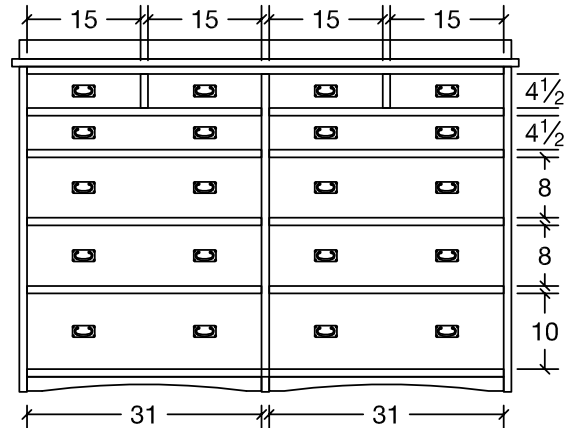

13-1803
Mule Chest
12 Drawers
67w x 20 1/2d x 46 1/2h

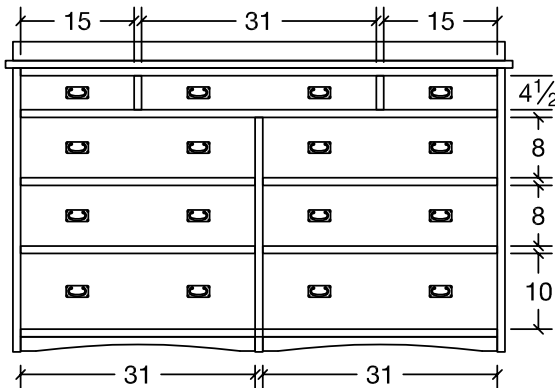

13-1804
9 Drawer Mule Chest
9 Drawers
67w x 20 1/2d x 38h

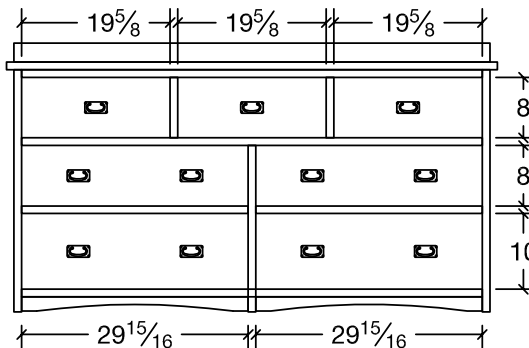

13-1701
7 Drawer Dresser
7 Drawers
65w x 20 1/2d x 35 1/2h

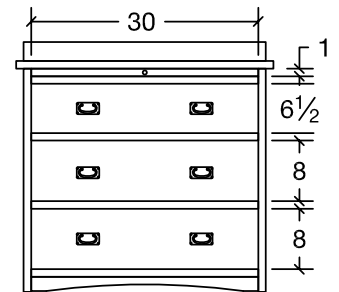

13-1801
3 Drawer Chest
3 Drawers
34w x 20 1/2d x 33h

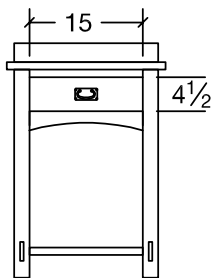

13-1601
1 Drawer Nightstand
1 Drawer
21w x 20d x 31h

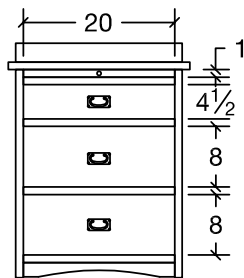

13-1602
3 Drawer Nightstand
3 Drawers
24w x 20 1/2d x 31h

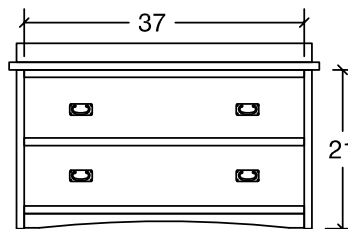

13-2101
Lift Top Blanket Chest
No Drawers
41w x 20 1/2d x 24 1/2h

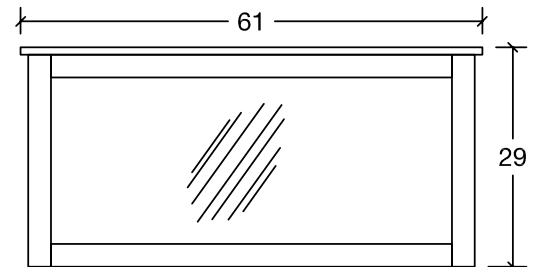

13-2002
Mule Mirror
61w x 29h

BUNGALOW

BEDROOM COLLECTION SPECIFICATIONS

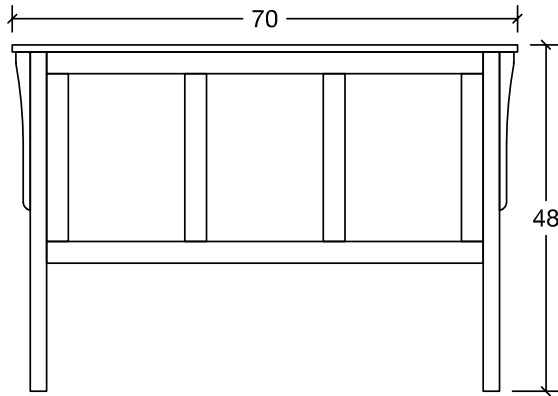

1-13-1502Q
Queen Panel Headboard
70w x 48h

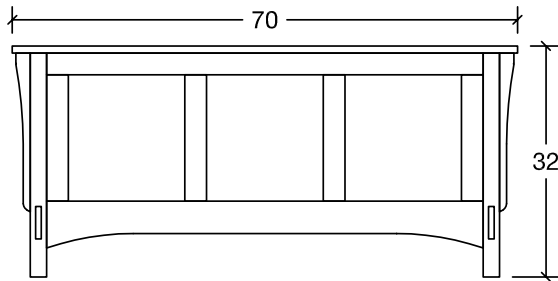

2-13-1502Q
Queen Panel Footboard
70w x 32h

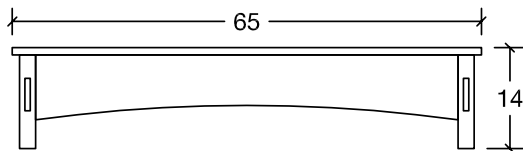

2-13-1502QLFB
Queen Panel
Low Footboard
65w x 14h

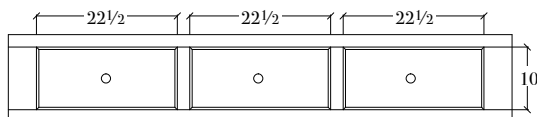

Storage Rail
3 drawer
14h

See pricelist for underbed
storage order info





CASTLEBROOK *Bedroom Collection*

COLLECTION FEATURES

- Bevel-cut mirror
- Mortise & tenon joints
- Dovetailed solid wood drawers
- Soft-close full access drawers
- Solid wood fully framed case goods
- 1 1/4" thick solid tops
- Decorative through tenons
- Yellowheart wood inlays
- W-1 & W-2 hardware is standard
- Mission edge is standard
- All nightstands feature
USB A & C Power

COLLECTION OPTIONS

- Hardware Options
(see Features & Options page)
- Docking drawer (#DKD)

Castlebrook 1-Drawer Night Stand

#CANS1
25"w x 18 1/2"d x 30 1/4"h
USB A & C Power



Castlebrook 3-Drawer Night Stand

#CANS3
25"w x 18 1/2"d x 30 1/4"h
USB A & C Power



Inlays are standard

Castlebrook Panel Bed

Headboard 56 1/4"h
Footboard 31 1/4"h
#CCAKB Cal King 81 1/4"w x 91 1/2"d
#CAKB King 85 1/4"w x 87 1/2"d
#CAQB Queen 69 1/4"w x 87 1/2"d
#CAFB Full 63 1/4"w x 82"d
#CATB Twin 50 1/4"w x 82"d



* see underbed storage options
on line drawings page.



**Castlebrook
6 Drawer Chest**
#CACD
41" w x 22" d x 53 1/4" h

**Castlebrook
32" Mirror**
#CAMR32
51" w x 2 1/2" d x 32" h



**Castlebrook
9-Drawer Dresser**
#CA9DR
65" w x 22" d x 43" h



**Castlebrook His & Hers Chest
7 Drawer, 2 Door**
#CAHHC
53" w x 22" d x 50 1/2" h

*1 shelf behind
each door

Castlebrook 40" Mirror
#CAMR40
51" w x 2 1/2" d x 40 1/2" h

**Castlebrook 7-Drawer
Dresser**
#CA7DR
65" w x 22" d x 33 1/4" h



CASTLEBROOK

BEDROOM COLLECTION SPECIFICATIONS

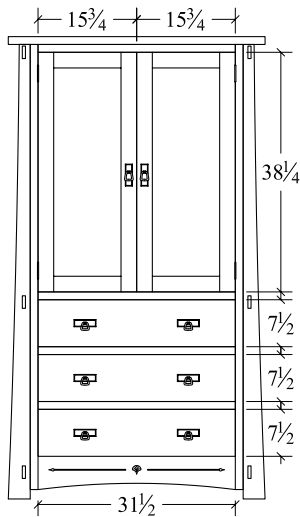

Armoire (CAAR)
3 drawer, 2 door
41w x 22d x 74h
*2 shelves

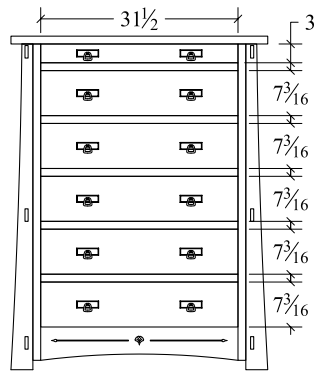

Chest (CACD)
6 drawer
41w x 22d x 53 1/4h

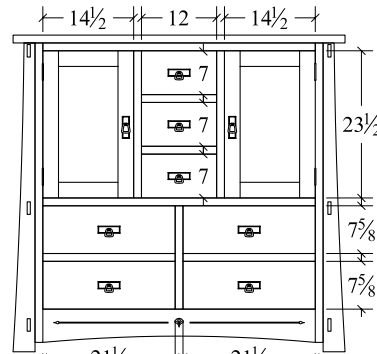

His & Hers Chest (CAHHC)
7 drawer, 2 door
53w x 22d x 50 1/2h
*1 shelf behind each door

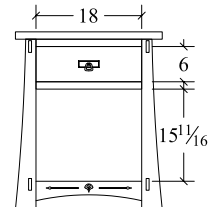

Night Stand (CANS1)
1 drawer, 1 opening
25w x 18 1/2d x 30 1/4h

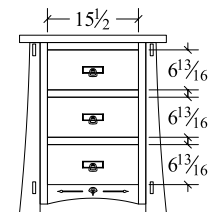

Night Stand (CANS3)
3 drawer
25w x 18 1/2d x 30 1/4h

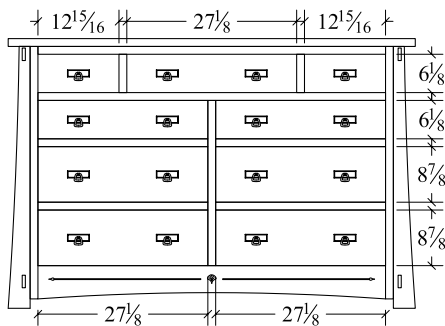

Dresser (CA9DR)
9 drawer
65w x 22d x 43h

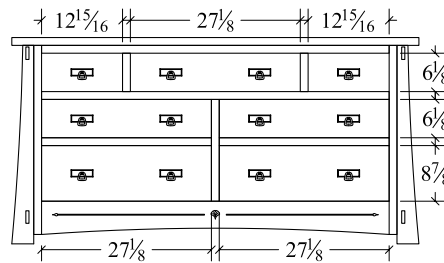

Dresser (CA7DR)
7 drawer
65w x 22d x 33 1/4h

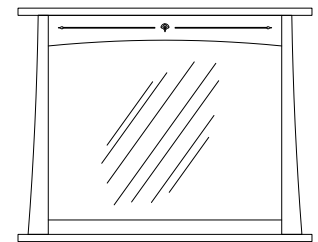

Mirror (CAMR40)
51w x 40 1/2h

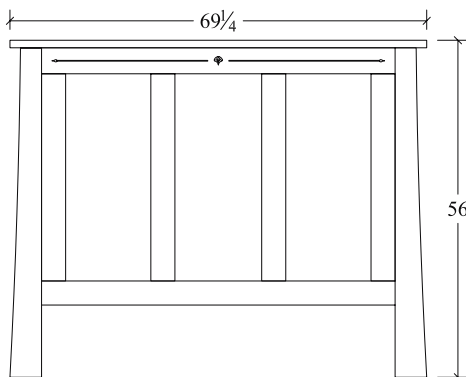

Queen Headboard 1-CAQB
69 1/4w x 56h

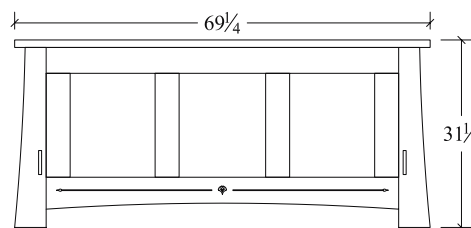

Queen Footboard 2-CAQB
69 1/4w x 31 1/4h

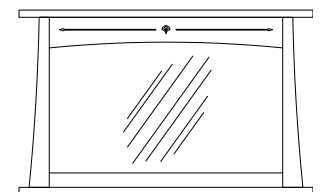

Mirror (CAMR32)
51w x 32h

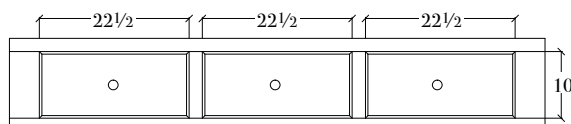

Storage Rail
3 drawer
14h

See pricelist for underbed storage order info



CEDAR LAKES *Bedroom Collection*

COLLECTION FEATURES

- Iron Bolt Detail
- Mirrors have bevel cut edges
- Constructed with mortise and tenon joints
- Cast dovetailed brackets support mattress
- Dovetailed solid wood drawers
- Soft-closing full access undermount drawer guides
- Chest features a cedar lined drawer bottom
- Dresser features dividers in second row drawers
- A-5 pulls and A-6 Knobs
- Bolts in corners will always be black, no other color options
- All nightstands feature USB A & C Power

COLLECTION OPTIONS

- Distressed Finish (#2D)
- Hardware Options
(see Features & Options page)
- Underbed Storage Options
- LED nightlight (#LEDN)
- Docking drawer with power (#DKD)



**Cedar Lakes
1-Drawer Night Stand**
#CLNS1
26" w x 16 1/2" d x 30" h
USB A & C Power



Shown in Oak with #100 Pebble Finish



**Cedar Lakes
60" Dresser Mirror**
#CLMR
42"w x 38 1/2"h



**Cedar Lakes
6 Drawer Chest**
#CLCD
38"w x 19"d x 53"h



**Cedar Lakes
60" Dresser**
#CLDR60
60"w x 19"d x 38"h



Cedar Lakes Bed
Headboard 60"h
Footboard 18"h
#CCLCKB Cal. King Bed 77 1/2"w x 90"d
#CLKB King Bed 81 1/2"w x 86"d
#CLQB Queen Bed 65 1/2"w x 86"d
#CLFB Full Bed 59 1/2"w x 80"d
#CLTB Twin Bed 44 1/2"w x 80"d

* see underbed storage options
on line drawings page.

CEDAR LAKES

BEDROOM COLLECTION SPECIFICATIONS

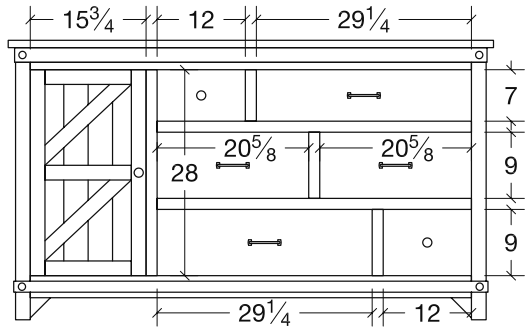

Door Dresser (CLDDR)

6 drawer, 1 door
66w x 19d x 38h

*1 shelf behind door

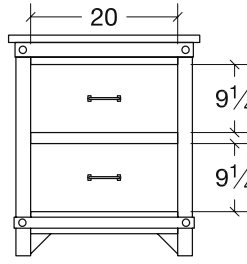

Night Chest (CLNS2)

2 drawer
26w x 16 1/2d x 30h

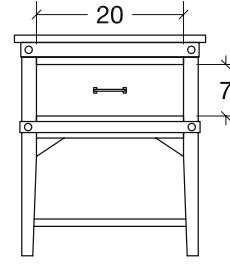

Night Table (CLNS1)

1 drawer, 1 Shelf
26w x 16 1/2d x 30h

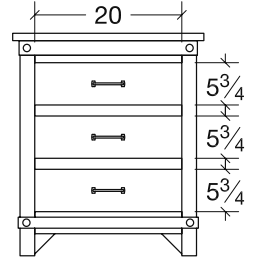

Night Stand (CLNS3)

3 drawer
26w x 16 1/2d x 30h

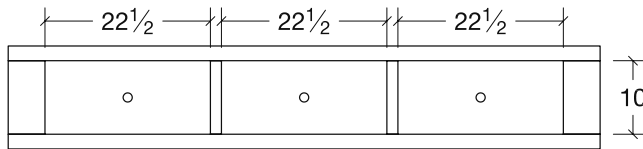

Storage Rail, King and Queen

3 drawer
80 1/2w x 14h

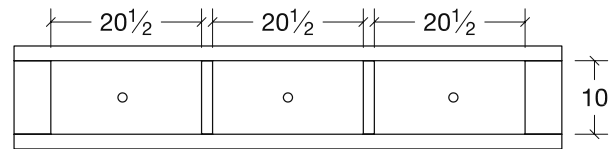

Storage Rail, Full

3 drawer
74 1/2w x 14h

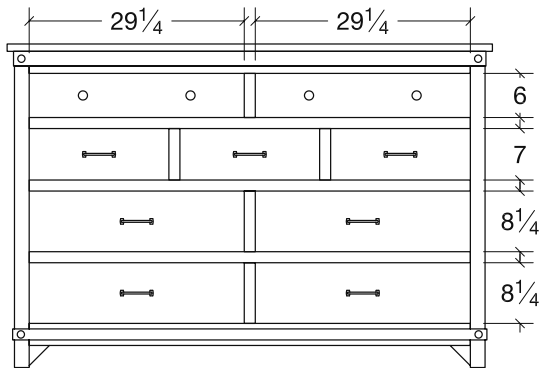

Tall Dresser (CL9DR)

9 drawer
66w x 19d x 44h

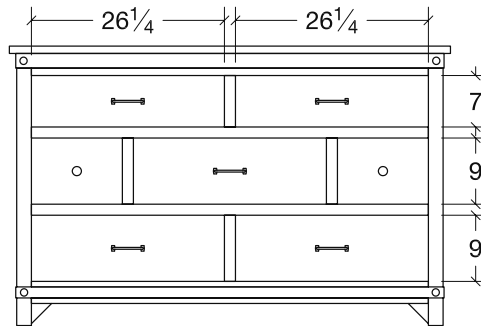

Dresser (CLDR60)

7 drawer
60w x 19d x 38h

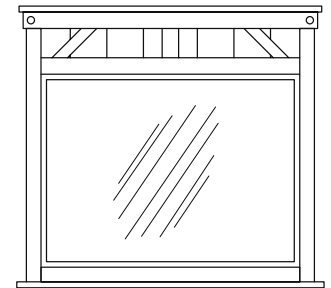

Dresser Mirror (CLMR)

42w x 38 1/2h

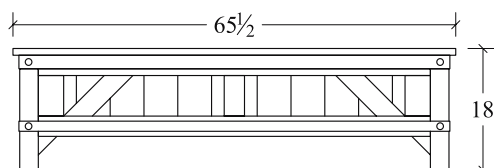

Queen Footboard (2-CLQB)

65 1/2w x 30h

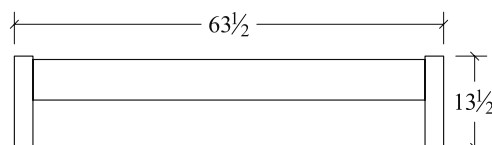

Queen Low Footboard (2-CLQBLFB)

63 1/2w x 13 1/2h

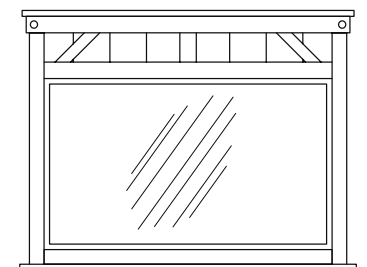

Dresser Mirror (CLMR 46)

46w x 35 1/2h

CEDAR LAKES

BEDROOM COLLECTION SPECIFICATIONS

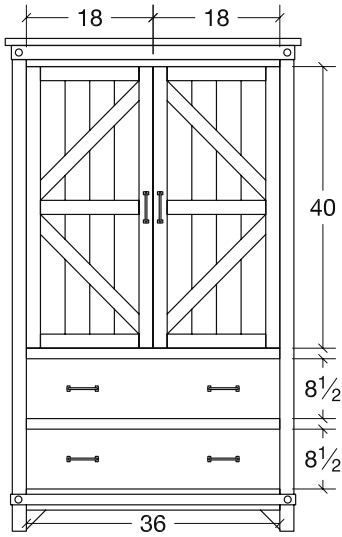

Armoire (CLAR)
2 drawer, 2 door
42w x 22d x 70h
*2 shelves and 1 hanger rod

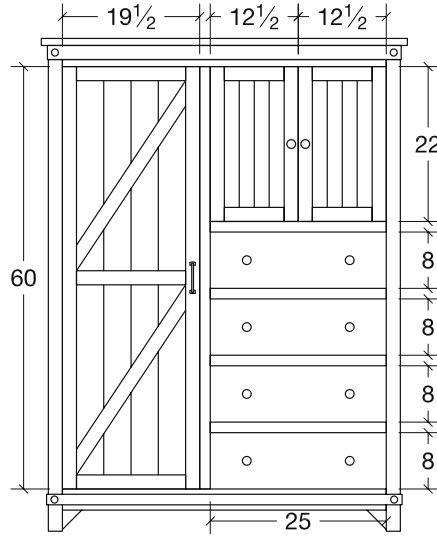

Chifferobe (CLCB)
4 drawer, 3 door
52w x 22d x 70h
*3 shelves and 1 rod behind long door
*1 shelf behind small doors

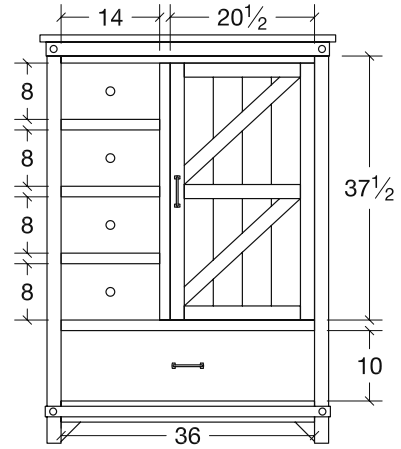

Door Chest (CLDRC)
5 drawer, 1 door
42w x 19d x 58h
*2 shelves

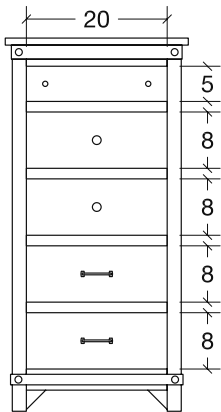

Lingerie Chest (CLLC)
5 drawer
26w x 16 1/2d x 53h

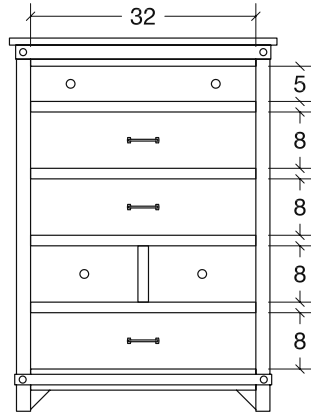

Drawer Chest (CLCD)
6 drawer
38w x 19d x 53h

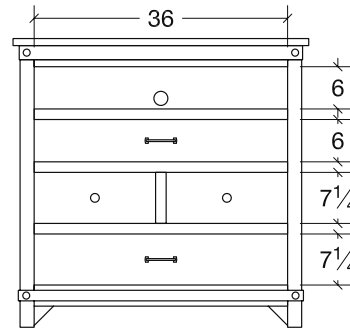

Media Chest (CLMC)
4 drawer
42w x 19d x 41h

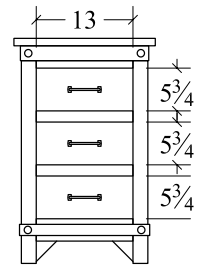

Night Stand (CLNS319)
3 drawer
19w x 16 1/2d x 30h

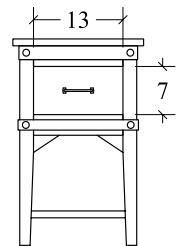

Night Table (CLNS119)
1 drawer, 1 Shelf
19w x 16 1/2d x 30h

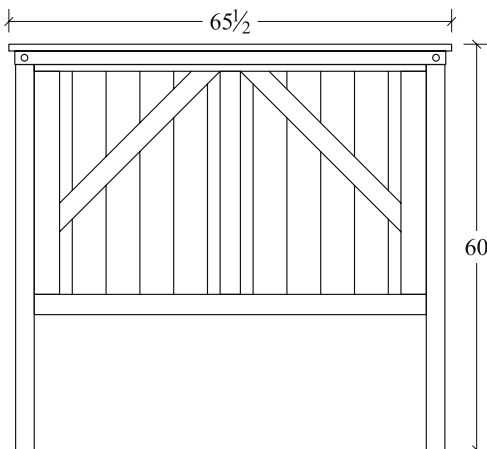

Queen Headboard 1-CLQB
65 1/2w x 60h

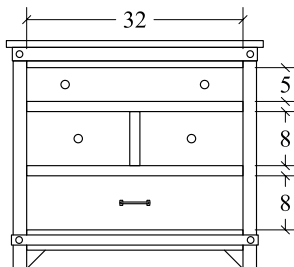

Drawer Chest (CLCD4)
4 drawer
38w x 19d x 34h

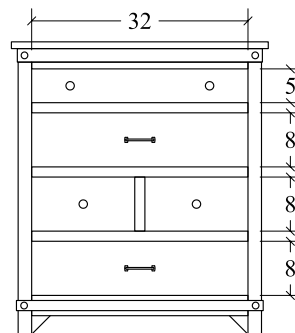

Drawer Chest (CLCD5)
5 drawer
38w x 19d x 43 1/2h

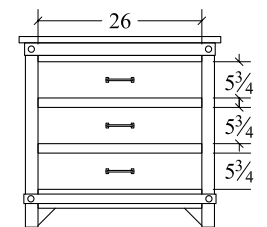

Night Stand (CLNS332)
3 drawer
32w x 16 1/2d x 30h

EMMA *Bedroom Collection*

COLLECTION FEATURES

- Constructed with mortise and tenon joints
- Cast dovetailed brackets support mattress
- Dovetailed, solid wood drawers
- Full access, side mounted, ball-bearing guides
- Hardware not available on other collections
- All nightstands feature USB A & C Power

COLLECTION OPTIONS

- Hardware options (see Features & Options page)
- Underbed storage available



- knob : 1586 FB
- pull : 53019 FB



Emma
3-Drawer Nightstand
#EANS3
23" w x 17" d x 28 1/2" h
USB A & C Power



Shown in Br. Maple with #113 Oatmeal finish

Emma 6 Drawer Chest
#EACD
37" w x 21 1/2" d x 51 1/2" h



Emma Mirror
#EAMR
37 5/8" w x 33 5/8" h



**Emma
7-Drawer Dresser**
#EADR
60" w x 21 1/2" d x 36 1/2" h

Emma Bed
Headboard 54" h
Footboard 19" h
#CEAKB Cal. King Bed 78" w
#EAKB King Bed 82" w
#EAQB Queen Bed 66" w
#EAFB Full Bed 60" w
#EATB Twin Bed 45" w



* see underbed storage options
on line drawings page.

EMMA

BEDROOM COLLECTION SPECIFICATIONS

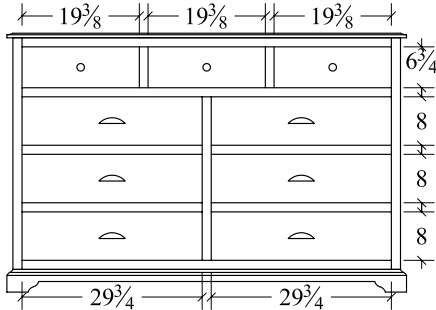

Dresser (EADR9)
9 drawer
66w x 21 1/2d x 42 3/4h

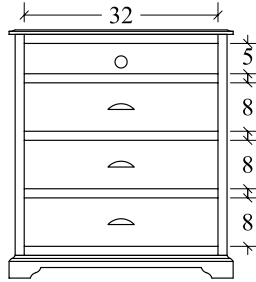

Media Chest (EAMC)
3 drawer, 1 opening
37w x 21 1/2d x 41h

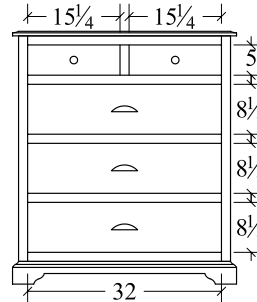

Chest (EACD5)
5 drawer
37w x 21 1/2d x 41 3/4h

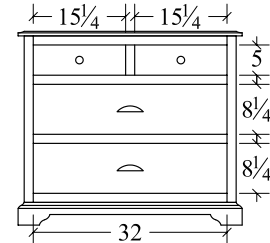

Chest (EACD4)
4 drawer
37w x 21 1/2d x 32h

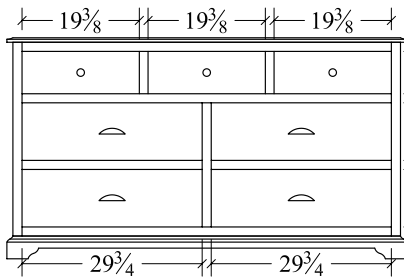

Dresser (EADR66)
7 drawer
66w x 21 1/2d x 36 1/2h

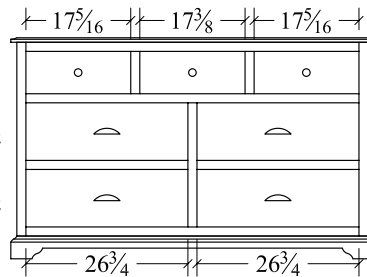

Dresser (EADR)
7 drawer
60w x 21 1/2d x 36 1/2h

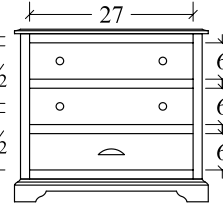

Night Stand (EANS332)
3 drawer
32w x 17d x 28 1/2h

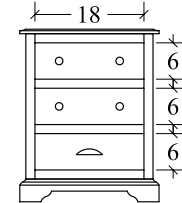

Night Stand (EANS3)
3 drawer
23w x 17d x 28 1/2h

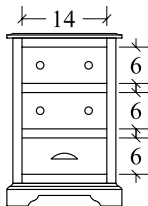

Night Stand (EANS319)
3 drawer
19w x 17d x 28 1/2h

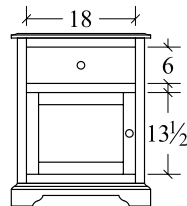

Night Stand (EANS11L)
1 drawer, 1 door
23w x 17d x 28 1/2h

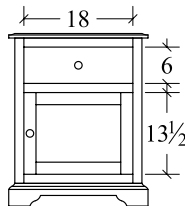

Night Stand (EANS11R)
1 drawer, 1 door
23w x 17d x 28 1/2h

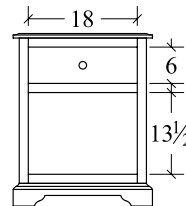

Night Stand (EANS1)
1 drawer
23w x 17d x 28 1/2h

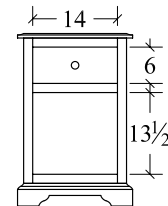

Night Stand (EANS119)
1 drawer
19w x 17d x 28 1/2h

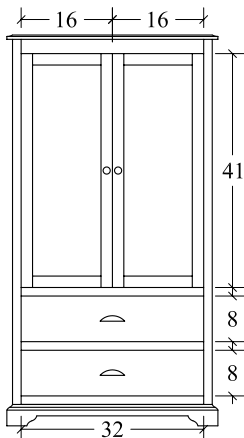

Armoire (EAAR)
2 drawer, 2 door
37w x 21 1/2d x 68 1/2h
*2 shelves and 1 hanger rod

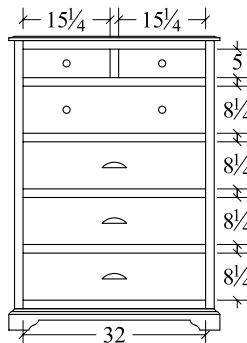

Chest (EACD)
6 drawer
37w x 21 1/2d x 51 1/2h

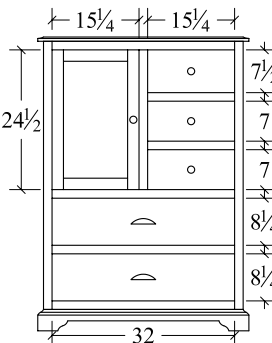

Door Chest (EADRC)
5 drawer, 1 door
37w x 21 1/2d x 51 1/2h

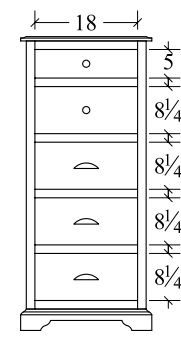

Lingerie Chest (EALC)
5 drawer
23w x 17d x 51 1/2h

EMMA

BEDROOM COLLECTION SPECIFICATIONS

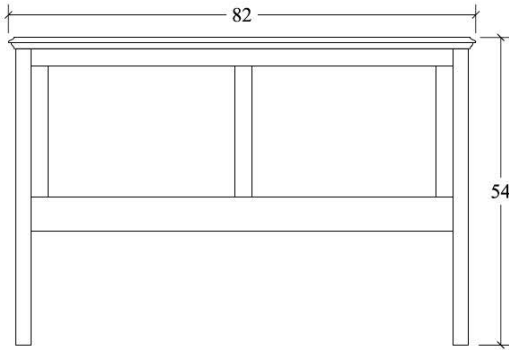

King Headboard 1-EAKB
82w x 54h

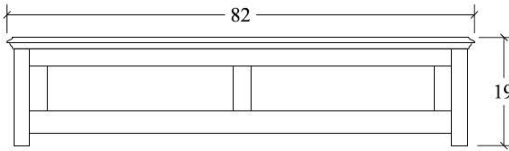

King Footboard 2-EAKB
82w x 19h

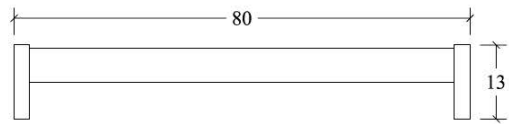

King Low Footboard 2-EAKBLFB
76w x 13h

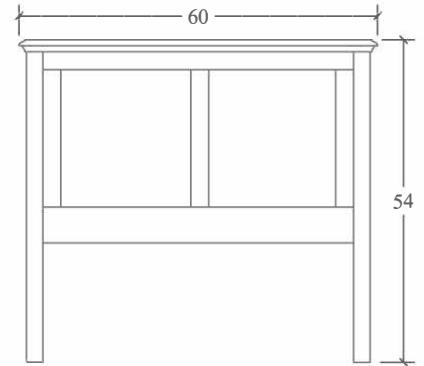

Full Headboard 1-EAFB
60w x 54h

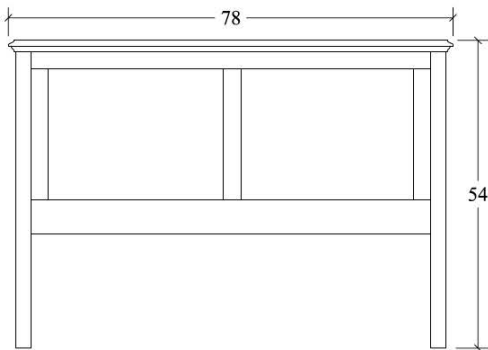

California King Headboard 1-CEAKB
78w x 54h

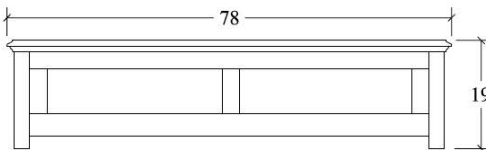

California King Footboard 1-CEAKB
78w x 19h

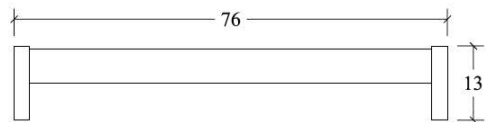

California King Low Footboard 2-CEAKBLFB
76w x 13h

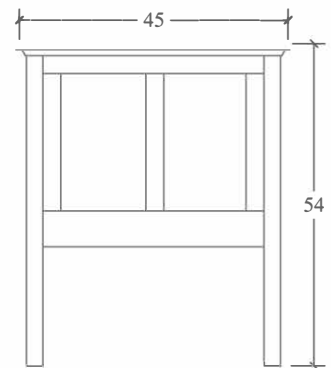

Twin Headboard 1-EATB
45w x 54h

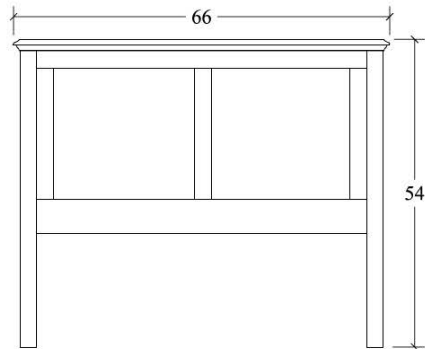

Queen Headboard 1-EAQB
66w x 54h

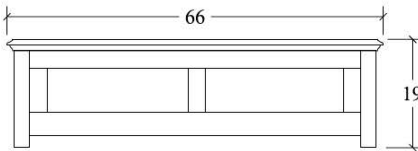

Queen Footboard 2-EAQB
66w x 19h

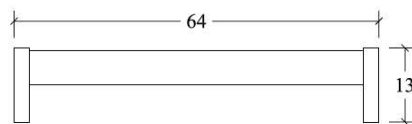

Queen Low Footboard 2-EAQBFLFB
64w x 13h

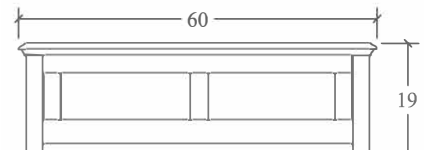

Full Footboard 2-EAFB
60w x 19h

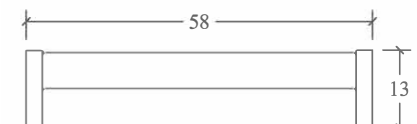

Full Low Footboard (2-EAFBLFB)
58w x 13h

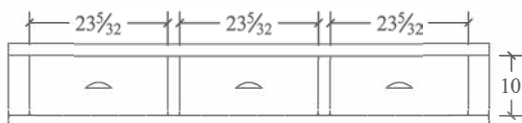

Storage Rail (EARS3)
3 drawer
80 1/2w x 14h



Mirror (EAMR)
37 3/8w x 33 3/8h

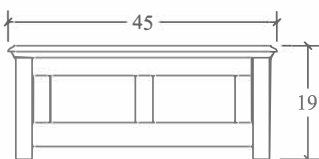

Twin Footboard 2-EATB
45w x 19h

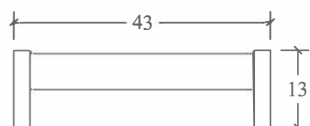

Twin Low Footboard 2-EATBLFB
43w x 13h

HARGROVE *Bedroom Collection*

COLLECTION FEATURES

- Constructed with mortise and tenon joints
- Cast dovetailed brackets support mattress
- Hardware not available on other collections
- Dovetailed drawers
- Soft-close full access drawers
- Mirror has a bevel cut edge
- Case goods are fully framed, solid wood
- Case goods feature 1" solid top
- Armoire features 2 solid hardwood, adjustable shelves
- Chest features a cedar-lined bottom drawer
- Hardware Z110-DACM
- All nightstands feature USB A & C Power

COLLECTION OPTIONS

- Hardware Options - see hardware page in Features & Options section
- Underbed Storage Options
- See upholstery book for fabric and leather choices
- Three plug power strip. Case goods available with touch switch LED night light (#LEDN)
- Night Stand available with sliding top, hidden compartment, lock and three plug power strip (#STP)
- Docking power drawer (#DKD)



Hargrove Bed

Headboard-89" H
Footboard-89" H
#CHEKB - Cal. King: 78" w x 91" d
#HEKB - King: 82" w x 87" d
#HEQB - Queen: 66" w x 87" d
#HEFB - Full: 61" w x 81" d



Hargrove Nightstand

#HENS2
28" w x 16" d x 29 1/2" h
USB A & C Power



Hargrove Bench

#HEBEN
28" w x 18" d x 19" h



Hargrove Panel Bed
 Headboard-67 1/2" H
 Footboard-20 1/4"H
 #CHEPKB - Cal. King: 78"w x 91" d
 #HEPKB - King: 84 5/8"w x 87" d
 #HEPQB - Queen: 67 1/2"w x 87" d
 #HEPFB - Full: 61"w x 81" d



Hargrove Mirror
 #HEMR42
 46" w x 42" h



Hargrove Mule Dresser
 #HEDR8
 66" w x 21 1/2" d x 42" h



Shown in Rustic White Oak wood
 with #121 Boardwalk stain color
 and C16-20 Horizon Fabric

HARGROVE

BEDROOM COLLECTION SPECIFICATIONS

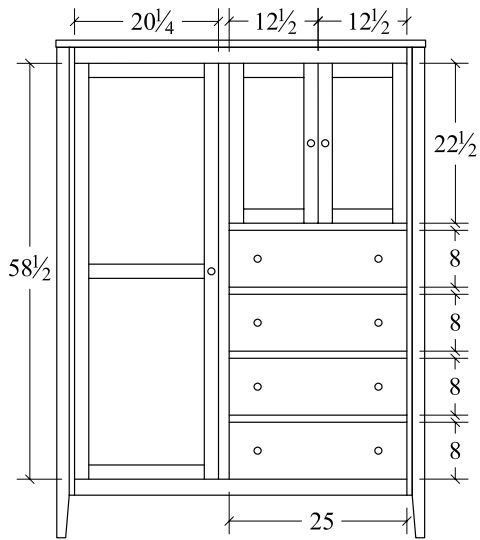

Chifferobe (HECB)
 4 drawer, 3 door
 1 shelf (behind small door)
 3 shelves, 1 rod (behind large door)
 52w x 21 1/2d x 70h

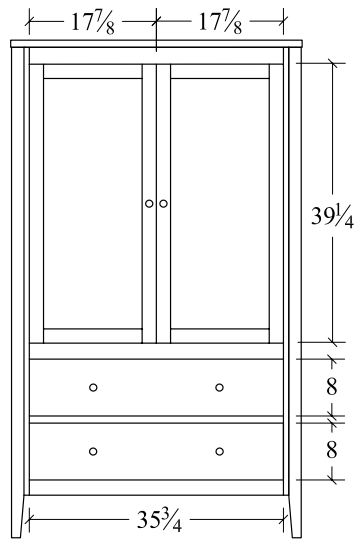

Armoire (HEAR)
 2 drawer, 2 door, 2 shelves
 41w x 21 1/2d x 70h
 *2 shelves and 1 hanger rod

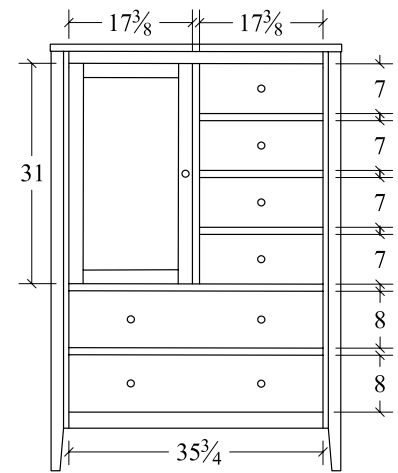

Door Chest (HEDRC)
 6 drawer, 1 door, 2 shelves
 41w x 21 1/2d x 60h

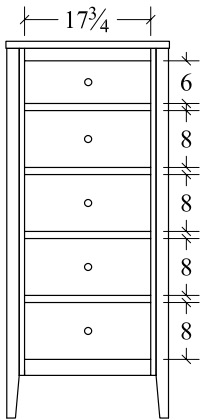

Lingerie Chest (HELIC)
 5 drawer
 23w x 16d x 53h

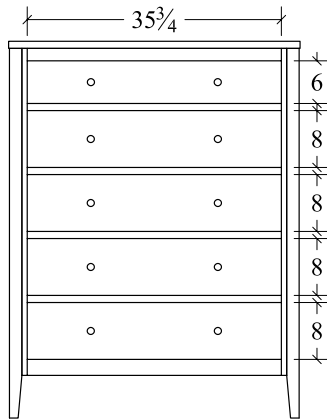

Chest (HECD)
 5 drawer
 41w x 21 1/2d x 53h

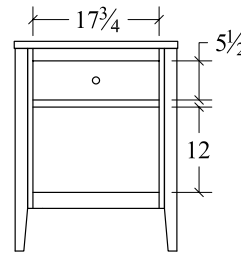

Nightstand (HENS1)
 1 drawer, 1 opening
 23w x 16d x 29 1/2h

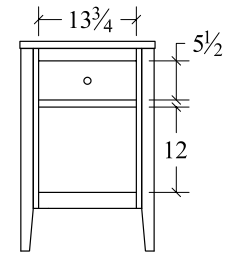

Nightstand (HENS119)
 1 drawer, 1 opening
 19w x 16d x 29 1/2h

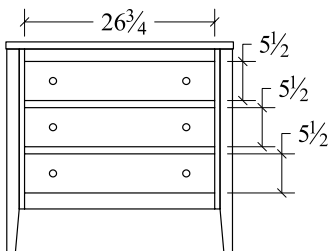

Nightstand (HENS332)
 3 drawer
 32w x 16d x 29 1/2h

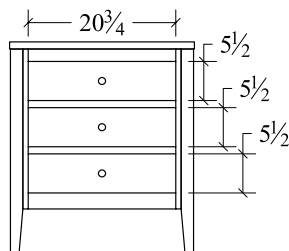

Nightstand (HENS3)
 3 drawer
 26w x 16d x 29 1/2h

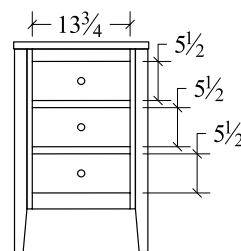

Nightstand (HENS319)
 3 drawer
 19w x 16d x 29 1/2h

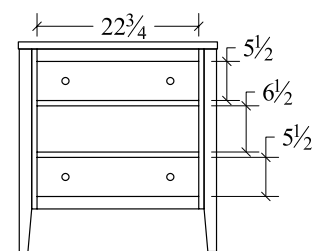

Nightstand (HENS2)
 2 drawer, 1 opening
 28w x 16d x 29 1/2h

the Hargrove

Drawing Scale: 1/2" = 1'

HARGROVE

BEDROOM COLLECTION SPECIFICATIONS

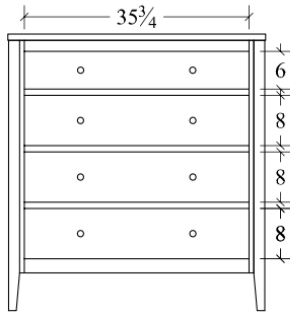

Chest (HECD4)
4 drawer
41w x 21 1/2d x 44h

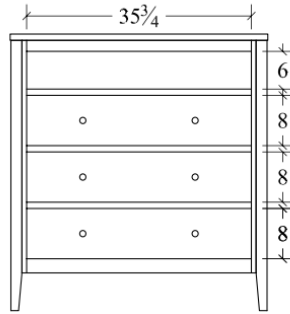

Media Chest (HEMC)
3 drawer, 1 opening
41w x 21 1/2d x 44h

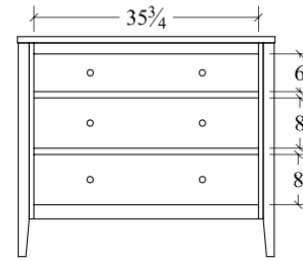

Chest (HECD3)
3 drawer
41w x 21 1/2d x 35h

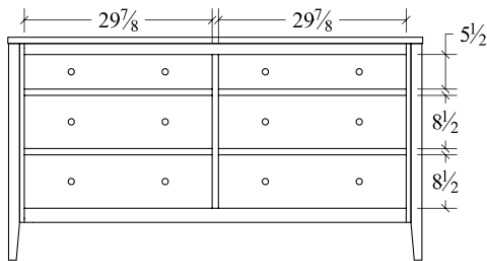

Dresser (HEDR66)
6 drawer
66w x 21 1/2d x 35 1/2h

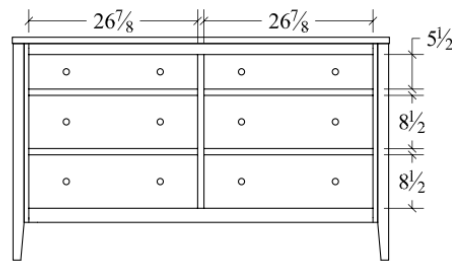

Dresser (HEDR60)
6 drawer
60w x 21 1/2d x 35 1/2h

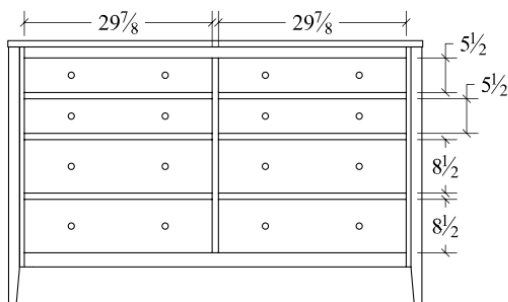

Mule Dresser (HEDR8)
8 drawer
66w x 21 1/2d x 42h

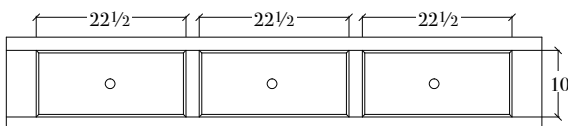

Storage Rail
3 drawer
14h

Cal King (3-2CHEKBRS)
King (3-2HEKBRS)
Queen (3-2HEQBRS)
Full (3-2HEFBRS)
Twin (3-2HETBRS)

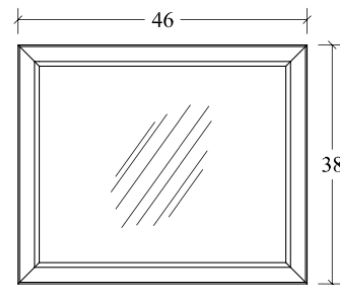

Mirror (HEMR38)
46w x 38h

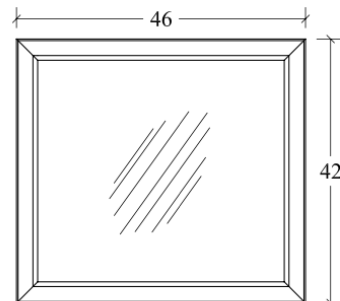

Mirror (HEMR42)
46w x 42h

the Hargrove

Drawing Scale: 1/2" = 1'

2024 NEW COLLECTION

HAYWORTH *Bedroom Collection*

COLLECTION FEATURES

- Mirror has a bevel-cut edge
- Constructed with mortise and tenon joints
- Cast dovetailed brackets support mattress
- Dovetailed, solid wood drawers
- Soft-closing, full access, undermount drawer guides
- Case goods are fully framed, solid wood
- Bevel edge is standard

- Case goods are built with floating panel construction
- Case goods feature 1" solid top
- Armoire features 2 solid hardwood, adjustable shelves
- Chest features a cedar-lined bottom drawer
- Dresser features dividers in second row drawers
- N-14 Black Hardware
- All nightstands feature USB A & C Power

COLLECTION OPTIONS

- Distressed finish (#2D)
- Hardware options - See hardware page in Features & Options section
- Foot rail instead of footboard (#1FD)
- 6 Drawer under bed storage unit (#2RS)
- Docking drawer (#DKD))



Hayworth Night Stand

#HYNS
27" w x 18" d x 30" h
USB A & C Power



Shown in Brown Maple with #30 Asbury and N-14 Black Hardware

Hayworth 6 Drawer Chest on Chest
 #HYCDC
 42" w x 22" d x 61" h



Hayworth Mirror
 #HYMR
 50" w x 32" h



Hayworth 10 Drawer Dresser
 #HYDR
 66" w x 22" d x 50" h



Hayworth Armoire
 #HYAR
 41" w x 22" d x 75" h
 *2 shelves



Hayworth Bed
 Headboard: 57" h
 Footboard: 31" h
 #CHYKB Cal. King: 78" w x 91" d
 #HYKB King: 83" w x 87" d
 #HYQB Queen: 67" w x 87" d
 #HYFB Full: 61" w x 81" d



* see underbed storage options on line drawings page.

HAYWORTH

BEDROOM COLLECTION SPECIFICATIONS

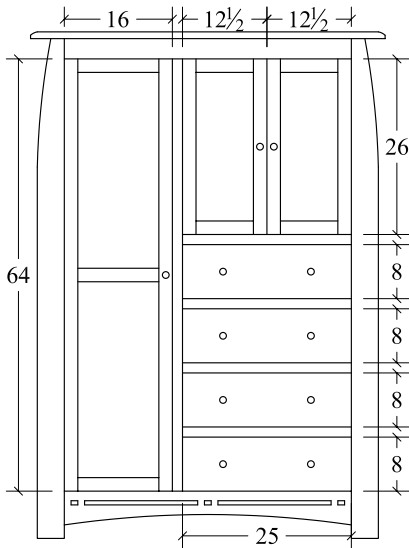

Chifferobe (HYCB)
4 drawer, 3 door
52½w x 22d x 75h
*1 shelf behind small doors
*3 shelves and 1 rod behind long door

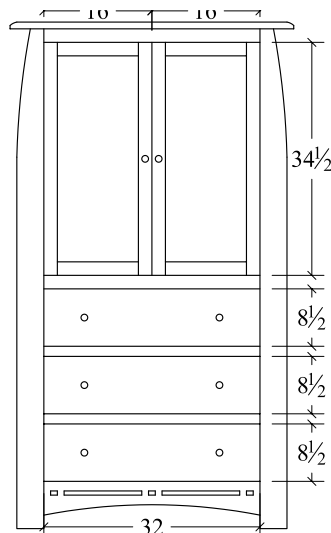

Armoire (HYAR)
3 drawer, 2 door
42w x 22d x 75h
*2 shelves and 1 hanger rod

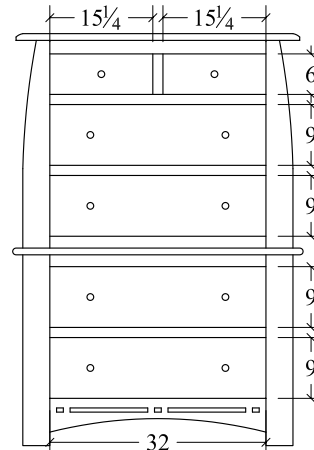

Chest on Chest (HYCDC)
6 drawer
42w x 22d x 61h

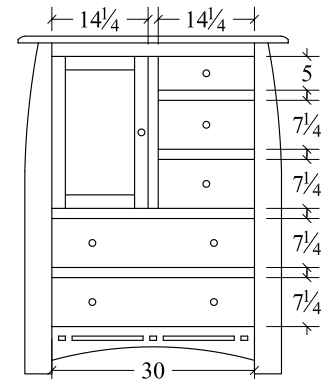

Door Chest (HYDC)
5 drawer, 1 door
40w x 22d x 50h
*1 shelf

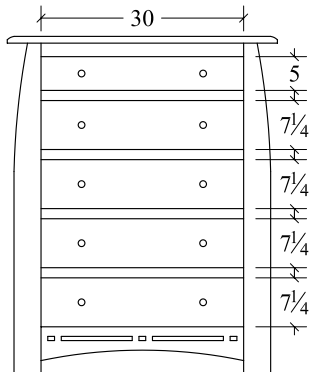

Chest (HYCD)
5 drawer
40w x 22d x 50h

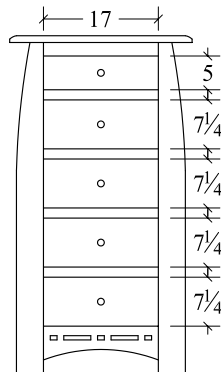

Lingerie Chest (HYLC)
5 drawer
27w x 18d x 50h

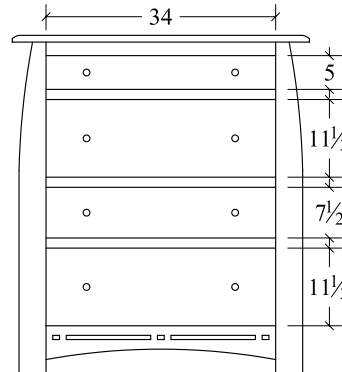

Desk Chest (HYDC)
4 drawer
44w x 22d x 50h

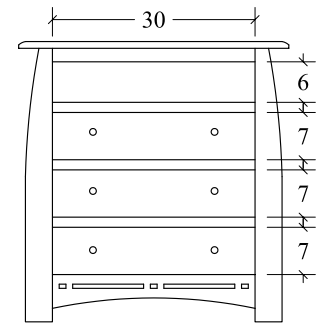

Media Chest (HYMC)
3 drawer, 1 opening
40w x 22d x 41½h

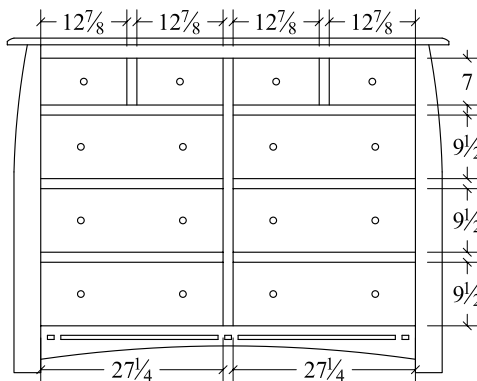

Dresser (HYDR)
10 drawer
66w x 22d x 50h

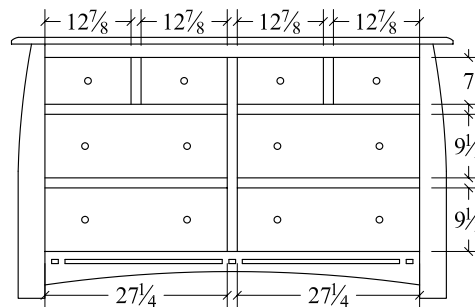

Dresser (HY8DR66)
8 drawer
66w x 22d x 39h

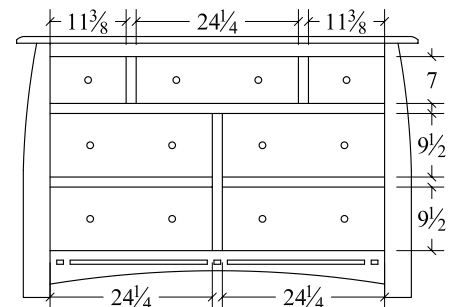

Dresser (HY7DR60)
7 drawer
60w x 22d x 39h

HAYWORTH

BEDROOM COLLECTION SPECIFICATIONS

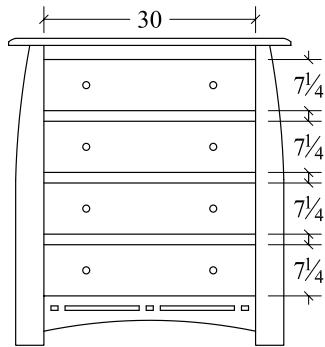

Chest (HYCD4)
4 drawer
40w x 22d x 44h

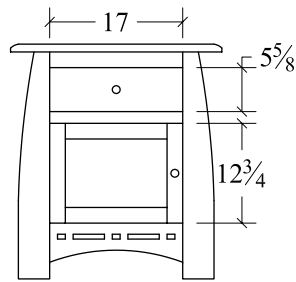

Nightstand (HYNSII)
1 drawer, 1 door
27w x 18d x 30h

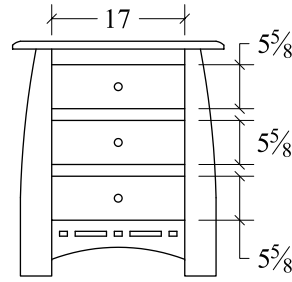

Nightstand (HYNS)
3 drawer
27w x 18d x 30h

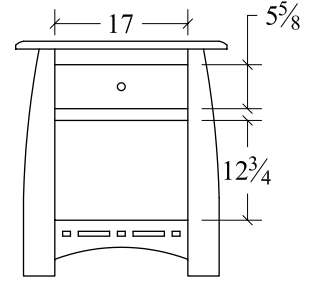

Nightstand (HYNSI)
1 drawer, 1 opening
27w x 18d x 30h

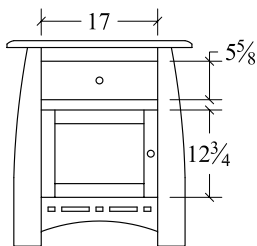

Nightstand (HYNSII)
1 drawer, 1 door
27w x 18d x 30h

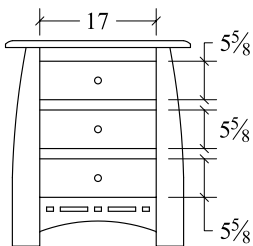

Nightstand (HYNS)
3 drawer
27w x 18d x 30h

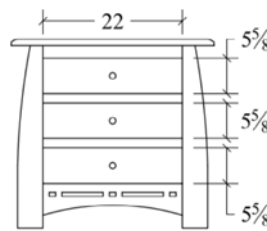

Nightstand (HYNS332)
3 drawer
32w x 18d x 30h

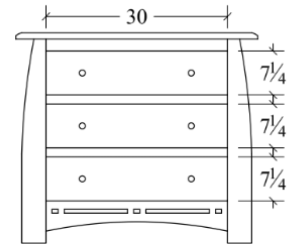

Chest (HYCD3)
3 drawer
40w x 22d x 36h

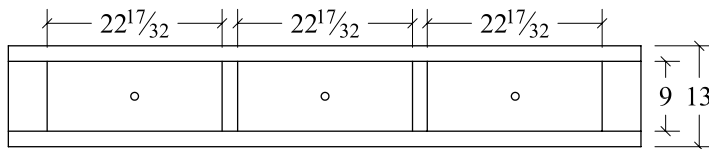

Bed Storage Rail
3 drawer

See pricelist for underbed storage order info

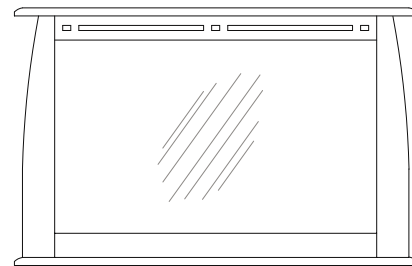

Mirror (HYMR)
50w x 32h

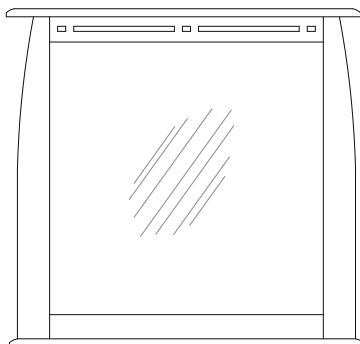

Mirror (HYMR44)
44w x 42h

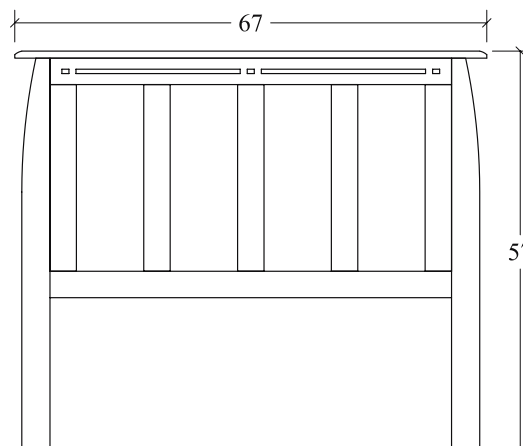

Queen Headboard 1-HYQB
67w x 57h

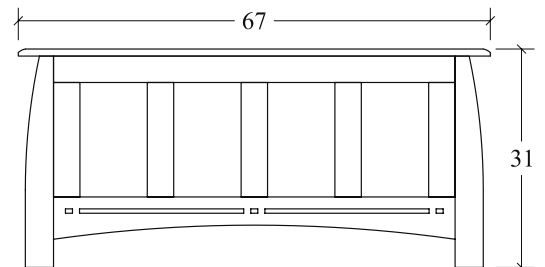

Queen Footboard 2-HYQB
67w x 31h

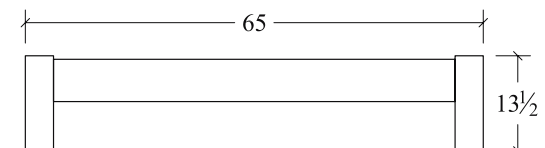

Queen Low Footboard 2-HYQBLFB
65w x 13 1/2h

PARKER *Bedroom Collection*

COLLECTION FEATURES

- Constructed with mortise and tenon joints
- Metal brackets support mattress
- Dovetailed, solid wood drawers
- Full extension, side mounted, ball-bearing guides
- T25 knobs for hardware
- All nightstands feature USB A & C Power

COLLECTION OPTIONS

- Hardware options (see Features & Options page)
- Underbed storage available



Parker Bed

Headboard posts: 50" h
Footboard posts: 18" h
#CPRKB Cal. King: 75 1/2" w x 88" d
#PRKB King: 79 1/2" w x 92" d
#PRQB Queen: 63 1/2" w x 88" d
#PRFB Full: 57 1/2" w x 84" d
#PRTB Twin: 42 1/2" w x 84" d

Parker Bed w/Storage Footboard

#PRKBSF King
#PRQBSF Queen
#CPRKBSF Cal King



Parker Dresser

#PRDR
60" w x 21 1/2" d x 37 1/2" h



Parker Chest

#PRCD
37" w x 21 1/2" d x 51 3/4" h

Parker 3 Drawer Nightstand

#PRNS3

23"w x 17"d x 27 3/4"h

USB A & C Power



Parker 1 Drawer Nightstand

#PRNS1

23"w x 17"d x 27 3/4"h

USB A & C Power



Brown Maple with #113 Oatmeal and #122 Eucalyptus on nightstands

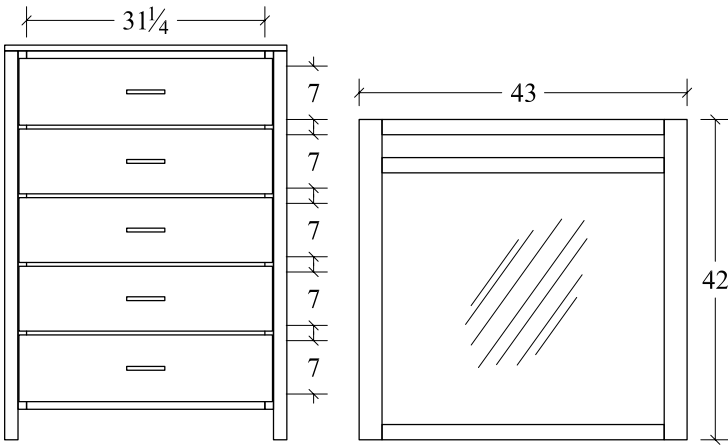

Chest (PRCD)
5 drawer
37w x 21 1/2d x 51 3/4h

Mirror (PRMR)
43w x 42h

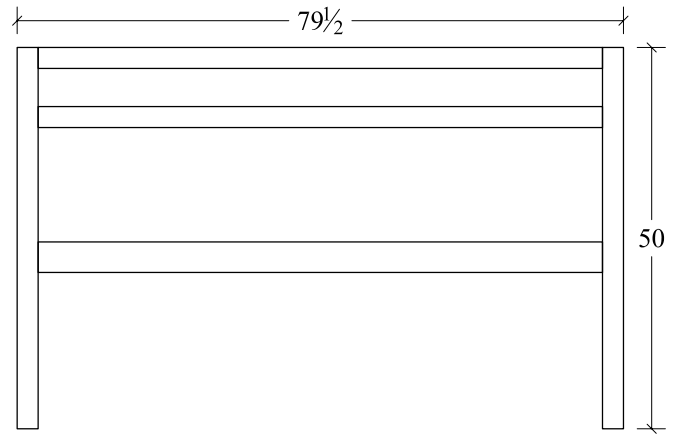

King Headboard (1-PRKB) 79 1/2w x 50h
Queen Headboard (1-PRQB) 63 1/2w x 50h
Full Headboard (1-PRFB) 57 1/2w x 50h
Twin Headboard (1-PRTB) 42 1/2w x 50h
Cal King Headboard 1-CPRKB 75 1/2w x 50h

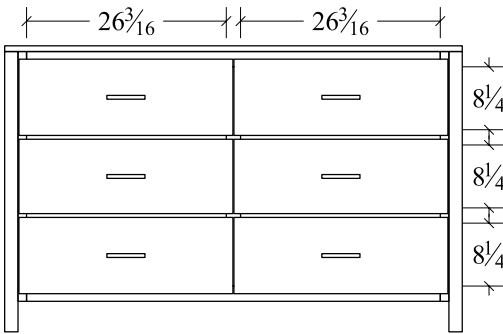

Dresser (PRDR)
6 drawer
60w x 21 1/2d x 37 1/2h

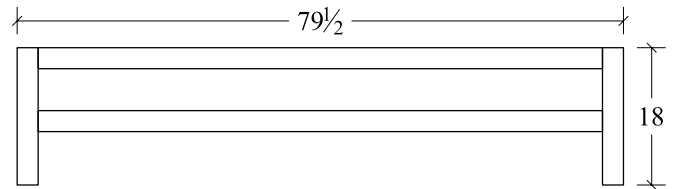

King Footboard (2-PRKB) 79 1/2w x 18h
Queen Footboard (2-PRQB) 63 1/2w x 18h
Full Footboard (2-PRFB) 57 1/2w x 18h
Twin Footboard (2-PRTB) 42 1/2w x 18h
Cal King Footboard 2-CPRKB 75 1/2w x 18h

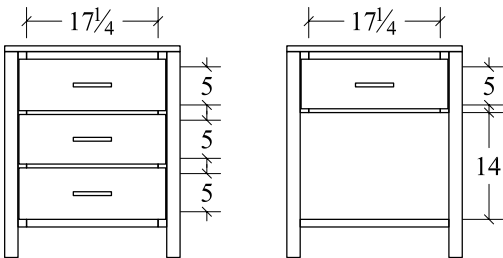

Nightstand (PRNS3)
3 drawer
23w x 17d x 27 3/4h

Nightstand (PRNS1)
1 drawer, 1 opening
23w x 17d x 27 3/4h

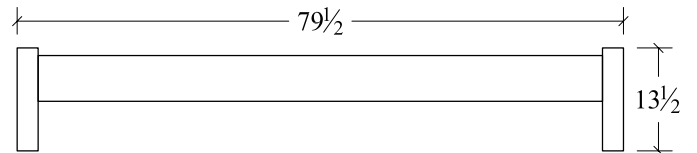

King Low Footboard (2-PRKBLFB) 79 1/2w x 13 1/2h
Queen Low Footboard (2-PRQBLFB) 63 1/2w x 13 1/2h
Full Low Footboard (2-PRFBLFB) 57 1/2w x 13 1/2h
Twin Low Footboard (2-PRTBLFB) 42 1/2w x 13 1/2h
Cal King Low Footboard (2-CPRKBLFB) 75 1/2w x 13 1/2h

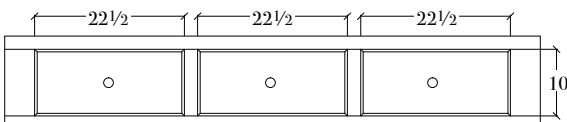

Storage Rail
3 drawer
14h
Cal King (3-2CPRKBRS)
King (3-2PRKBRS)
Queen (3-2PRQBRS)
Full (3-2PRFBRS)
Twin (3-2PRTBRS)

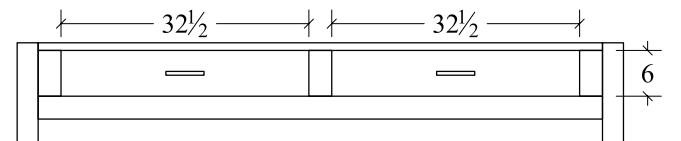

King Storage Footboard (2-PRKSF) 79 1/2w x 13h
Queen Storage Footboard (2-PRQSF) 63 1/2w x 13h
Full Storage Footboard (2-PRFSF) 57 1/2w x 13h
Twin Storage Footboard (2-PRTSF) 42 1/2w x 13h
Cal King Storage Footboard (2-CPRKSF) 75 1/2w x 13h

the Parker

Drawing Scale: 1/2" = 1'



PLATTE RIVER *Bedroom Collection*

COLLECTION FEATURES

- Constructed with mortise and tenon joints
- Cast dovetailed brackets support mattress
- Dovetailed, solid wood drawers
- Full access, side mounted, ball-bearing guides
- SO-1 knobs for hardware
- All nightstands feature USB A & C Power

COLLECTION OPTIONS

- Hardware options (see Features & Options page)
- Underbed storage available



Platte River
3 Drawer Nightstand
#PLRUNS3
23" w x 17" d x 29 1/2" h
USB A & C Power



Shown in Brown Maple with #113 Oatmeal



**Platte River
52" Dresser Mirror**
#PLRUMR
52"w x 40"h



**Platte River
6 Drawer Chest**
#PLRUCD
37"w x 21 1/2"d x 53"h

**Platte River 7
Drawer 60" Dresser**
#PLRU DR
60"w x 21 1/2"d x 38"h



Platte River Bed
Headboard posts: 51" h
Footboard posts: 19" h
#CPLRUKB Cal. King: 79" w x 92" d
#PLRUKB King: 83" w x 88" d
#PLRUQB Queen: 67" w x 88" d
#PLRUFB Full: 61" w x 84" d
#PLRUTB Twin: 48" w x 84" d

*See underbed storage options on line drawings page.



Platte River Upholstered Bed
Headboard posts: 51" h
Footboard posts: 19" h
#CPLRUKB Cal. King: 79" w x 92" d
#PLRUKB King: 83" w x 88" d
#PLRUQB Queen: 67" w x 88" d
#PLRUFB Full: 61" w x 84" d
#PLRUTB Twin: 48" w x 84" d

PLATTE RIVER

BEDROOM COLLECTION SPECIFICATIONS

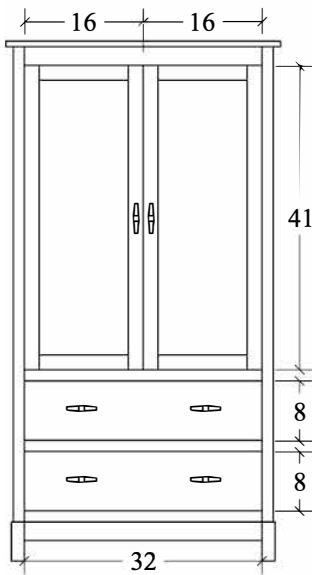

Armoire (PLRAR)
2 drawer, 2 door
37w x 21 1/2d x 70h

*2 shelves and
1 hanger rod

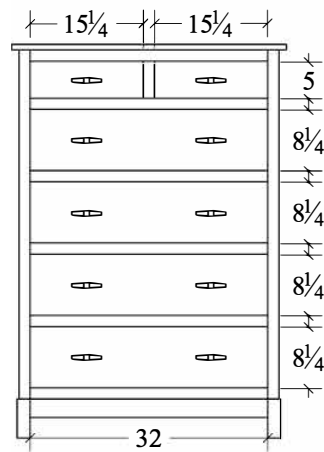

Chest (PLRCD)
6 drawer
37w x 21 1/2d x 53h

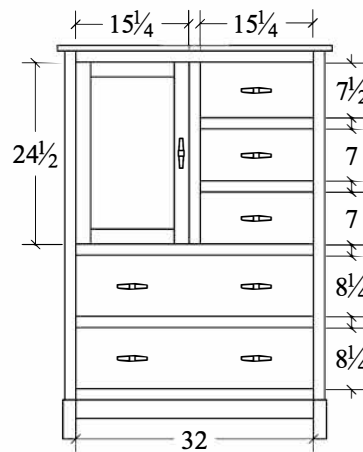

Door Chest (PLRDRC)
5 drawer, 1 door 37w x
21 1/2d x 53h

*1 shelf behind door

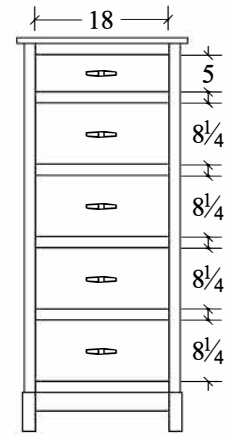

Lingerie Chest (PLRLC)
5 drawer
23w x 17d x 53h

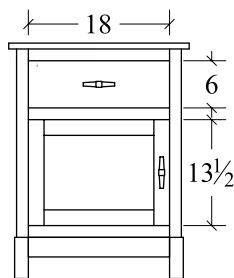

Night Stand (PLRNS11L)
1 drawer, 1 door
23w x 17d x 29 1/2h

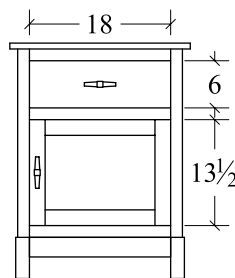

Night Stand (PLRNS11R)
1 drawer, 1 door
23w x 17d x 29 1/2h

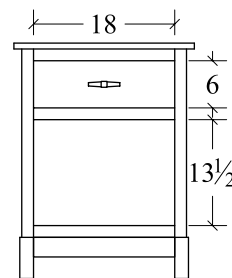

Night Stand (PLRNS1)
1 drawer
23w x 17d x 29 1/2h

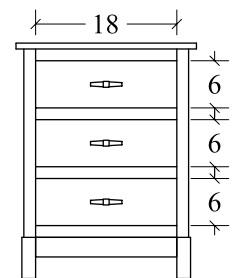

Night Stand (PLRNS3)
3 drawer
23w x 17d x 29 1/2h

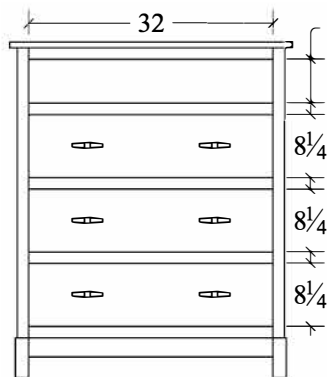

Media Chest (PLRMC)
3 drawer, 1 opening
37w x 21 1/2d x 44h

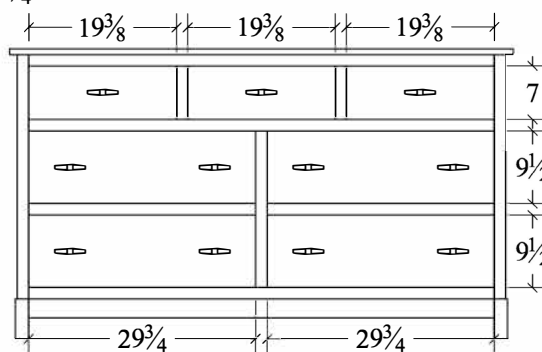

Dresser (PLRDR66)
7 drawer
66w x 21 1/2d x 38h

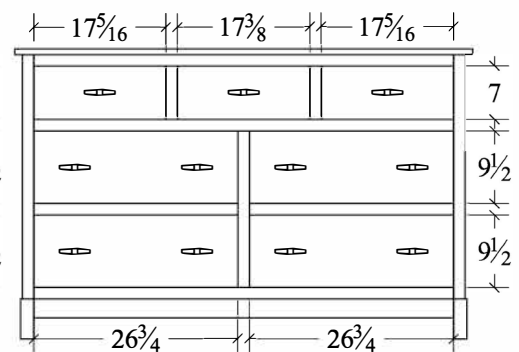

Dresser (PLRDR)
7 drawer
60w x 21 1/2d x 38h

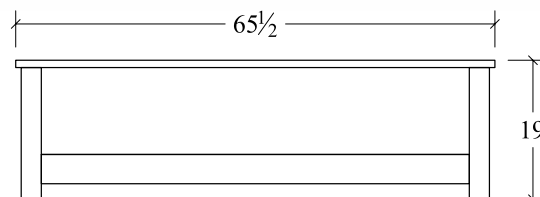

Queen Footboard (2-PLRQB)
65 1/2w x 19h

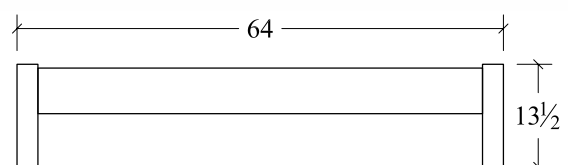

Queen Low Footboard (3-PLRQBLFB)
64w x 13 1/2h

PLATTE RIVER

BEDROOM COLLECTION SPECIFICATIONS

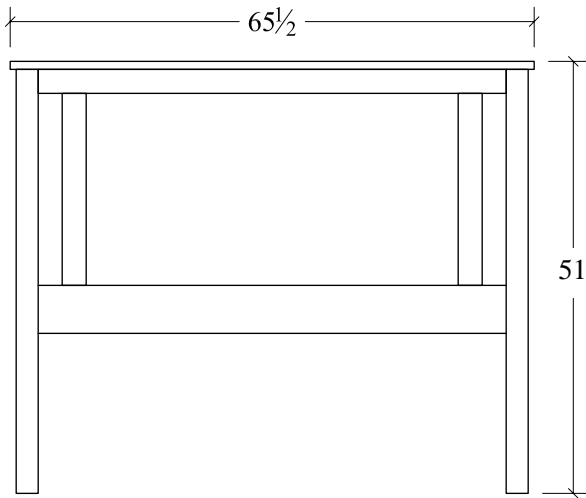

Queen Headboard (1-PLRQB)

65 1/2w x 54h

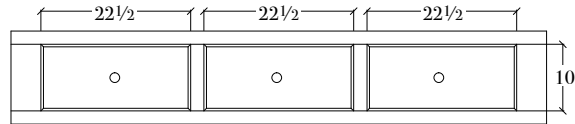

Storage Rail
3 drawer
14h

Cal King (3-2CPLKBRS)
King (3-2PLKBRS)
Queen (3-2PLQBRS)
Full (3-2PLFBRS)
Twin (3-2PLTBRS)

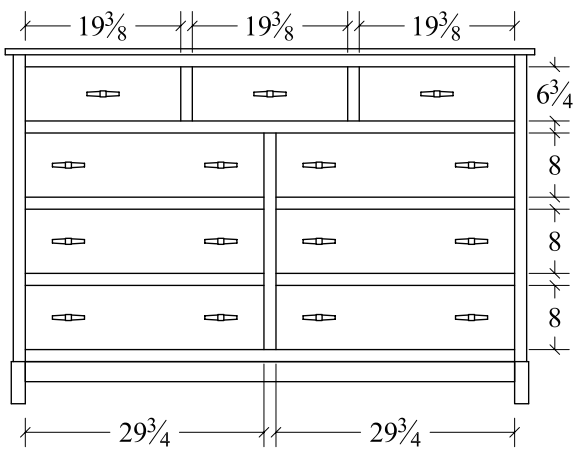

Dresser (PLRDR9)

9 drawer

66w x 21 1/2d x 44 1/4h

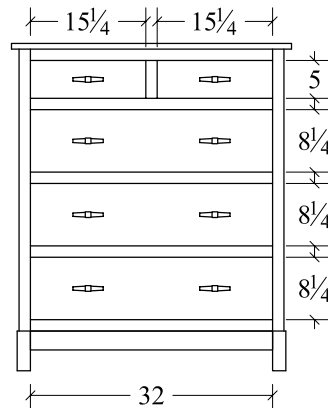

Chest **PLRCD5**

5 drawer

37w x 21 1/2d x 43 1/4h

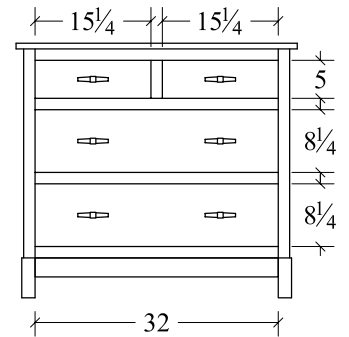

Chest **PLRCD4**

4 drawer

37w x 21 1/2d x 33 1/2h

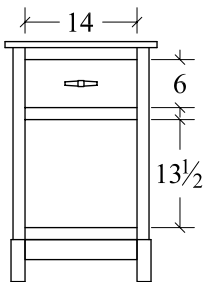

Night Stand (PLRNS119)

1 drawer

19w x 17d x 29 1/2h

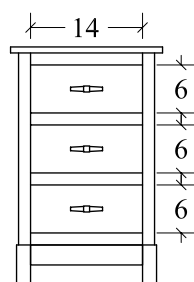

Night Stand (PLRNS319)

3 drawer

19w x 17d x 29 1/2h

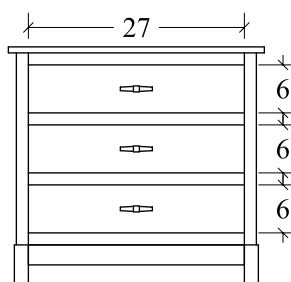

Night Stand (PLRNS332)

3 drawer

32w x 17d x 29 1/2h

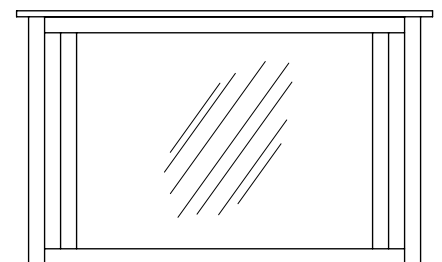

Mirror (PLRMR32)

52w x 32h

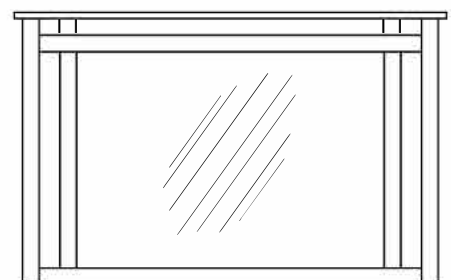

Mirror (PLRMR)

52w x 40h

RIVERSIDE *Bedroom Collection*

COLLECTION FEATURES

- Constructed with mortise and tenon joints
- Cast dovetailed brackets support mattress
- Hardware not available on other collections
- Dovetailed drawers
- Soft-close full access drawers
- Mirror has a bevel cut edge
- Case goods are fully framed, solid wood
- Case goods feature 1" solid top
- Armoire features 2 solid hardwood, adjustable shelves
- Chest features a cedar-lined bottom drawer
- AR Hardware
- All nightstands feature USB A & C Power

COLLECTION OPTIONS

- Hardware Options - see hardware page in Features & Options section
- Underbed Storage Options
- See upholstery book for fabric and leather choices
- Three plug power strip. Case goods available with touch switch LED night light (#LEDN)



Riverside Panel Bed

Headboard - 56" h

Footboard - 17" h

#CRSPKB - Cal. King: 75 1/2" w x 92" d

#RSKPHB - King: 79 1/2" w x 88" d

#RSKPQB - Queen: 63 1/2" w x 88" d

#RSKPFB - Full: 57 1/2" w x 84" d

#RSKPTB - Twin: 42 1/2" w x 84" d



Riverside 2 Drawer Nightstand

#RSNS2

28" w x 16" d x 25" h

USB A & C Power

Riverside 3 Drawer Chest

#RSNS332

32" w x 16" d x 27 3/4" h

USB A & C Power



Shown in Oak with #115 Harbor Gray

RIVERSIDE *Bedroom Collection*

CONTINUED...



Riverside 5 Drawer Dresser

#RSCD
38" w x 18 1/4" d x 54" h



Riverside Upholstered Bed

Headboard - 56" h
Footboard - 17" h
#CRSUKB - Cal. King: 76 1/2" w x 92" d
#RSUKB - King: 80 1/2" w x 88" d
#RSUQB - Queen: 64 1/2" w x 88" d
#RSUFB - Full: 58 1/2" w x 84" d
#RSUTB - Twin: 43 1/2" w x 84" d



Riverside 6 Drawer Chest

#RSDR66
66" w x 18 1/4" d x 34 3/4" h



Riverside Wrap Upholstered Bed

Headboard - 56" h
Footboard - 17" h
#CRSWKB - Cal. King: 76.5" w x 92" d
#RSWKB - King: 80 1/2" w x 88" d
#RSWQB - Queen: 64 1/2" w x 88" d
#RSWFB - Full: 58 1/2" w x 84" d
#RSWTB - Twin: 43 1/2" w x 84" d

RIVERSIDE BEDROOM COLLECTION SPECIFICATIONS

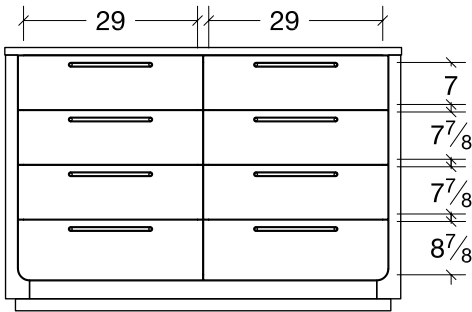

Chest (RSDR8)
8 drawer
66w x 18¹/₈d x 44h

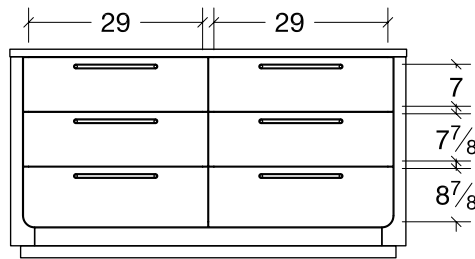

Chest (RSDR66)
6 drawer
66w x 18¹/₈d x 34³/₄h

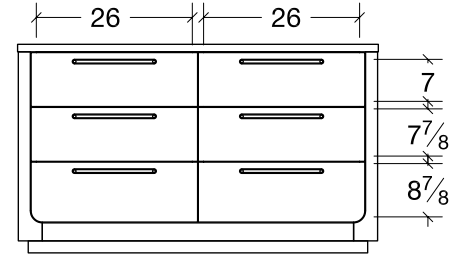

Chest (RSDR)
6 drawer
60w x 18¹/₈d x 34³/₄h

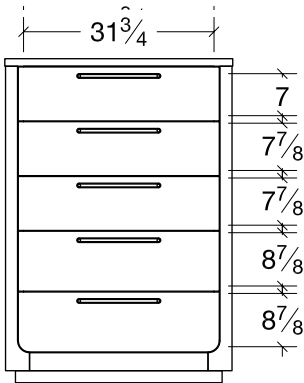

Chest (RSCD)
5 drawer
38w x 18¹/₈d x 54h

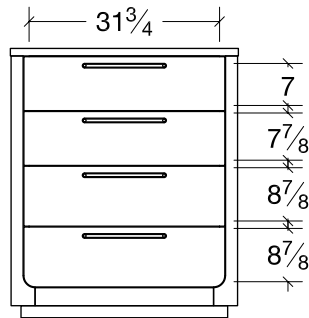

Chest (RSCD4)
4 drawer
38w x 18¹/₈d x 45h

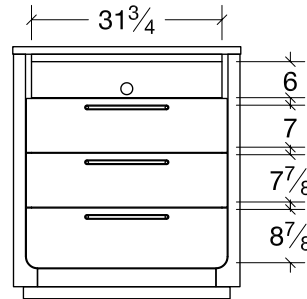

Media Chest (RSMC)
3 drawer
38w x 18¹/₈d x 42h

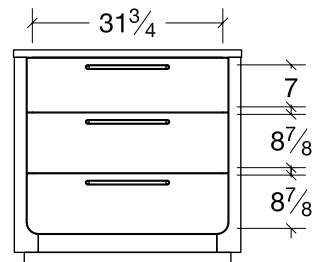

Chest (RSCD3)
3 drawer
38w x 18¹/₈d x 35³/₄h

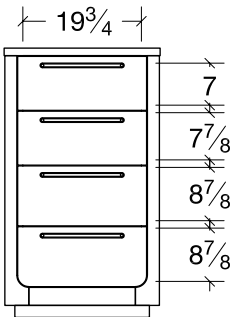

Chest (RSLC)
4 drawer
26w x 16¹/₈d x 45h

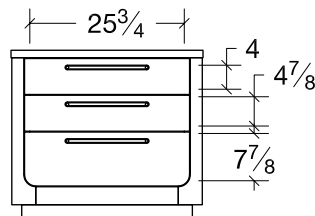

Chest (RSNS332)
3 drawer
32w x 16d x 27³/₄h

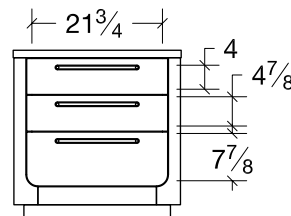

Chest (RSNS3)
3 drawer
28w x 16d x 27³/₄h

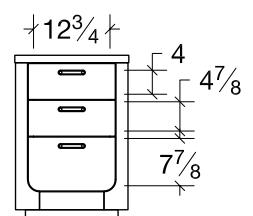

Chest (RSNS319)
3 drawer
19w x 16d x 27³/₄h

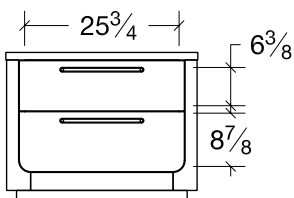

Nightstand (RSNS232)
2 drawer
32w x 16d x 25h

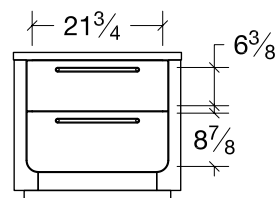

Nightstand (RSNS2)
2 drawer
28w x 16d x 25h

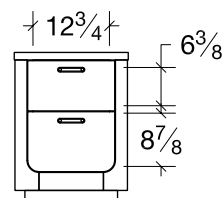

Nightstand (RSNS219)
2 drawer
19w x 16d x 25h

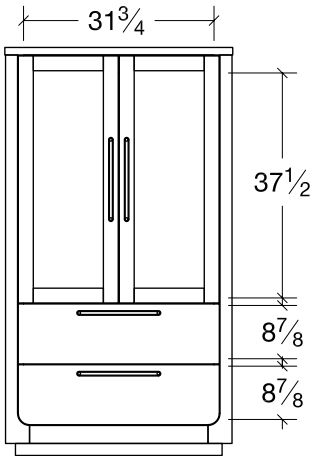

Armoire (RSAR)
2 drawer, 2 door
38w x 21d x 68h

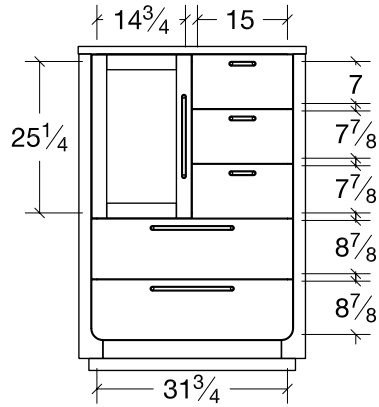

Door Chest (RSDRC)
5 drawer, 1 door
38w x 18 1/8d x 54h

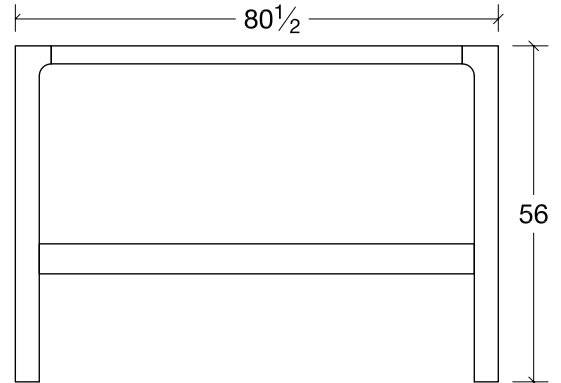

King Headboard, Panel & Fabric
80 1/2w x 56h

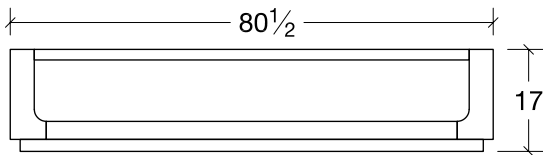

King Footboard
80 1/2w x 17h

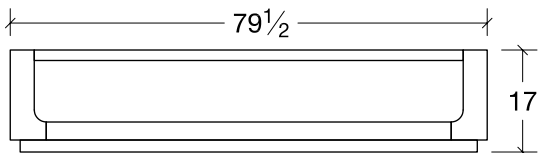

King Panel Footboard
79 1/2w x 17h

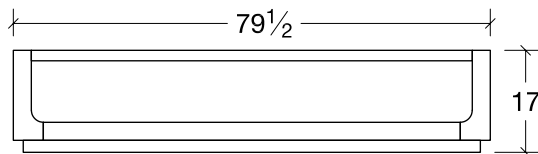

King Footboard
79 1/2w x 17h

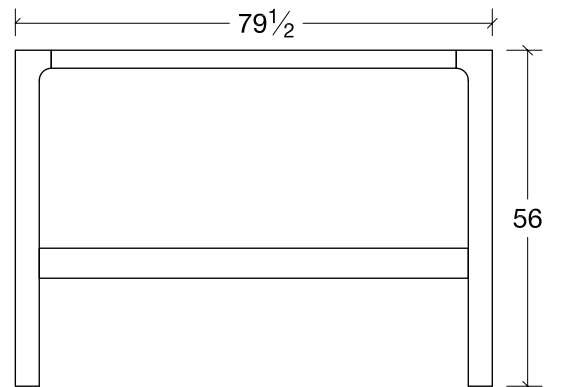

King Panel Headboard
79 1/2w x 56h

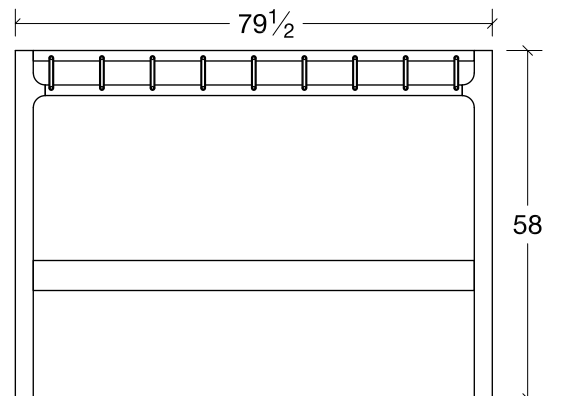

King Headboard
79 1/2w x 58h



SELBY *Bedroom Collection*

COLLECTION FEATURES

- Constructed with mortise and tenon joints
- Metal brackets support mattress
- Dovetailed, solid wood drawers
- Full access, side mounted, ball-bearing guides
- SB-1 knobs for hardware
- All nightstands feature USB A & C Power

COLLECTION OPTIONS

- Hardware options (see Features & Options page)
- Underbed storage available



Selby Bed

Headboard posts: 46" h
Footboard posts: 13.1/8" h
#CSBKB Cal. King: 82 1/2" w x 92" d
#SBKB King: 86 1/2" w x 88" d
#SBQB Queen: 70 1/2" w x 88" d
#SBFB Full: 64 1/2" w x 84" d
#SBTB Twin: 49 1/2" w x 84" d



Selby Dresser

#SBDR
60" w x 21 1/2" d x 37 1/2" h



Selby Mirror

#SBMR
43" x 39"



Selby Chest
#SBCD
37" w x 21 1/2" d x 51" h



Selby 1 Drawer Nightstand
#SBNS1
23" w x 17" d x 27 3/4" h
USB A & C Power



Selby 3 Drawer Nightstand
#SBNS3
23" w x 17" d x 27 3/4" h
USB A & C Power



Brown Maple with #113 Oatmeal

SELBY BEDROOM COLLECTION SPECIFICATIONS

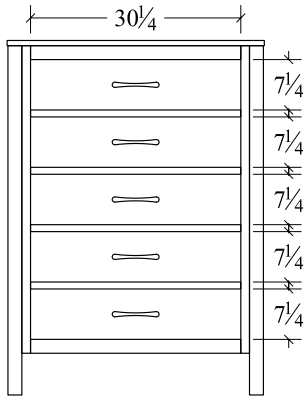

Chest (SBCD)
5 drawer
37w x 21 1/2d x 51h

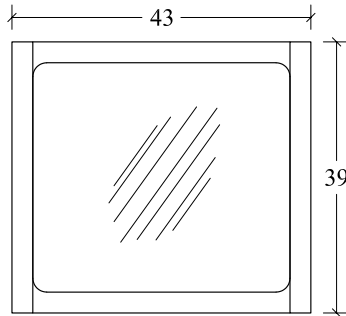

Mirror (SBMR)
43w x 39h

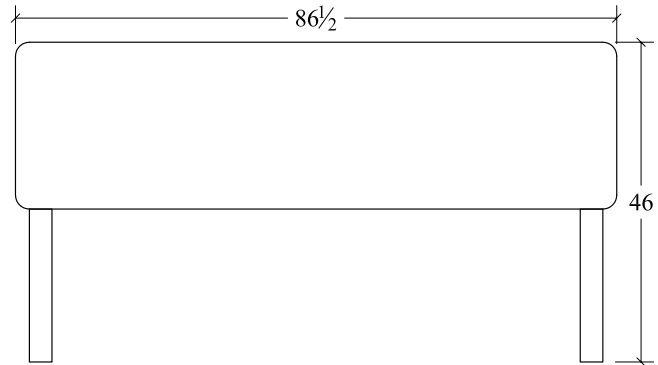

King Headboard (1-SBKB) 86 1/2w x 46h
Queen Headboard (1-SBQB) 70 1/2w x 46h
Full Headboard (1-SBFB) 64 1/2w x 46h
Twin Headboard (1-SBTB) 49 1/2w x 46h
Cal King Headboard (1-CSBKB) 82 1/2w x 46h



Dresser (SBDR)
6 drawer
60w x 21 1/2d x 37 1/2h

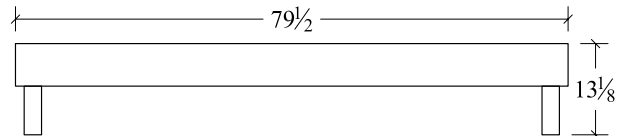

King Footboard (2-SBKB) 79 1/2w x 13 1/8h
Queen Footboard (2-SBQB) 63 1/2w x 13 1/8h
Full Footboard (2-SBFB) 57 1/2w x 13 1/8h
Twin Footboard (2-SBTB) 42 1/2w x 13 1/8h
Cal King Footboard (2-CSBKB) 75 1/2w x 13 1/8h

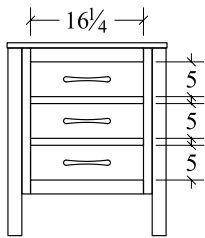

Nightstand (SBNS3)
3 drawer
23w x 17d x 27 3/4h

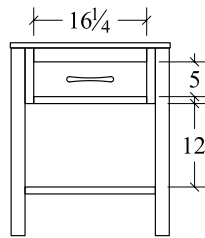

Nightstand (SBNS1)
1 drawer, 1 opening
23w x 17d x 27 3/4h

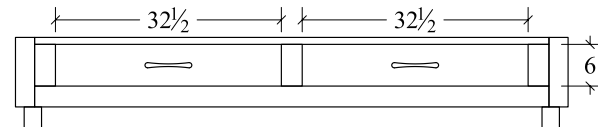

King Storage Footboard (2-SBKBSF) 79 1/2w x 13h
Queen Storage Footboard (2-SBQBSF) 63 1/2w x 13h
Full Storage Footboard (2-SBFBSF) 57 1/2w x 13h
Twin Storage Footboard (2-SBTBSF) 42 1/2w x 13h
Cal King Storage Footboard (2-CSBKBSF) 75 1/2w x 13h

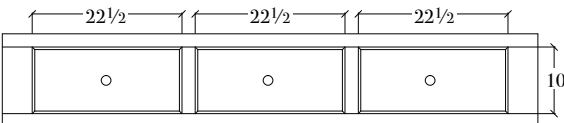

Storage Rail
3 drawer
14h

the Selby

Drawing Scale: 1/2" = 1'

VICTOR *Bedroom Collection*

COLLECTION FEATURES

- Live edges on bed & tops
- Mortise & tenon joints
- Dovetailed solid wood drawers
- Soft-close full access drawers
- Fully framed solid wood case goods
- 1 1/4" thick tops
- Bevel-cut mirror
- Mattress supported with cast dovetail brackets
- Two solid hardwood adjustable shelves on armoire
- Cedar lined bottom drawer on chest
- Dividers in second row drawers on dresser
- Black hardware (not available on other collections)
- All nightstands feature USB A & C Power

COLLECTION OPTIONS

- Hardware Options (see Features & Options page)
- Optional under bed storage unit
- Touch switch LED night light (#LEDN)
- Night Stand available with sliding top, hidden compartment, lock & three-plug power strip (#STP)

See Features & Options section for expectations and details on live edge tops.



Brushed black hardware is exclusive to the Victor Collection



Victor 2-Drawer Nightstand

#VINS
27 1/2" w x 17" d x 28 1/2" h
USB A & C Power

Victor Bed

Headboard 52" h
Footboard 13 1/2" h
#CVIKB Cal King 76" w x 90 1/2" d
#VIKB King 80" w x 86 1/2" d
#VIQB Queen 64" w x 86 1/2" d
#VIFB Full 58" w x 80 1/2" d
#VITB Twin 43" w x 80 1/2" d



* see underbed storage options on line drawings page.

VICTOR *Bedroom Collection*

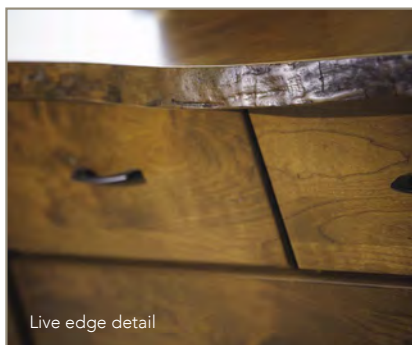

Victor 48" Mirror
#VIMR48
48" w x 32" h



Victor Chest
#VICD
41 1/2" w x 22 1/4" d x 53" h



Victor 7-Drawer Dresser
#VI7DR66
67 1/2" w x 22 1/4" d x 36" h

VICTOR

BEDROOM COLLECTION SPECIFICATIONS

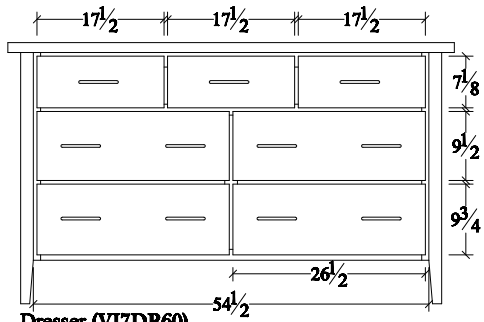

Dresser (VI7DR60)
7 drawer
61 1/2 w x 22 1/4 d x 36h

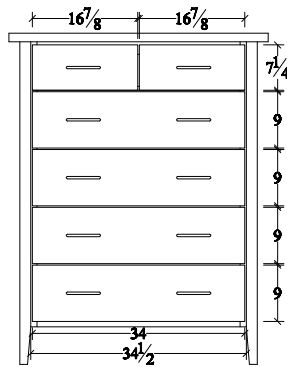

Chest (VICD)
6 Drawer
42 1/2 w x 22 1/4 d x 53h

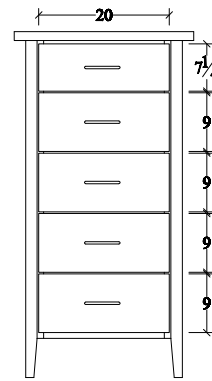

Lingerie Chest (VILC)
5 drawer
27 1/2 w x 17d x 53h

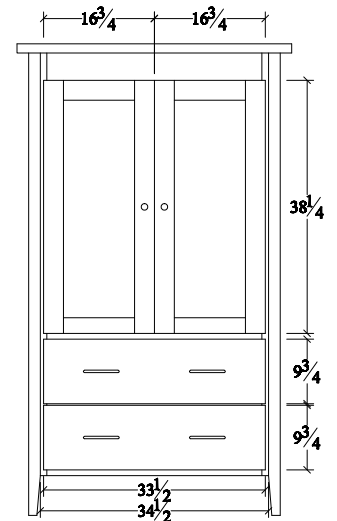

Armoire (VIAR)
2 drawer, 2 door
41 1/2 w x 22 1/4 d x 71 1/4 h

* 2 shelves and 1 hanger rod

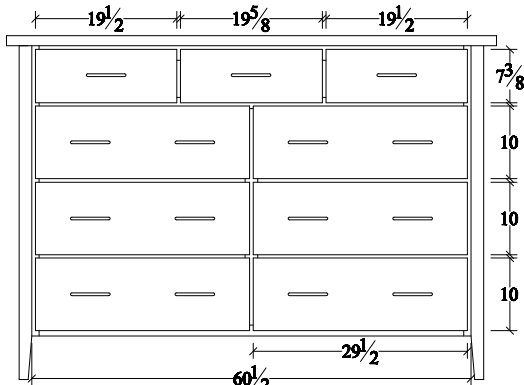

Dresser (VIDR9)
9 drawer
67 1/2 w x 22 1/4 d x 46h

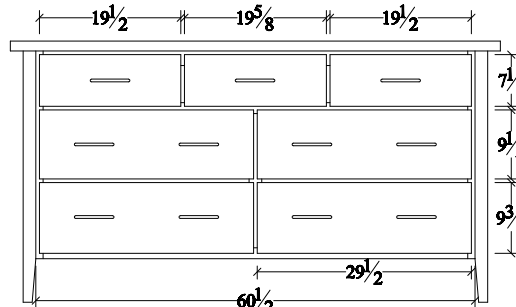

Dresser (VI7DR66)
7 drawer
67 1/2 w x 22 1/4 d x 36h

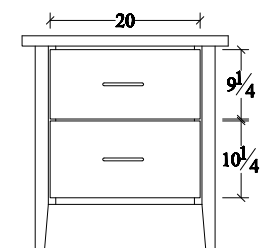

Nightstand (VINS)
2 drawers
27 1/2 w x 17d x 28 1/2 h

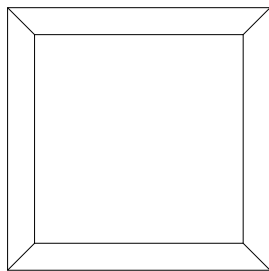

Mirror (VIMR42)
42w x 42h

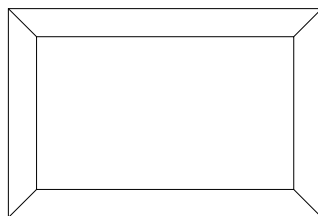

Mirror (VIMR32)
48w x 32h

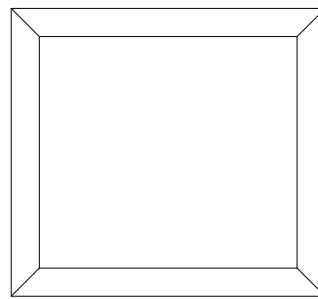

Mirror (VIMR48)
48w x 44h

10 1/2 23 1/4 23 1/4 10 1/2

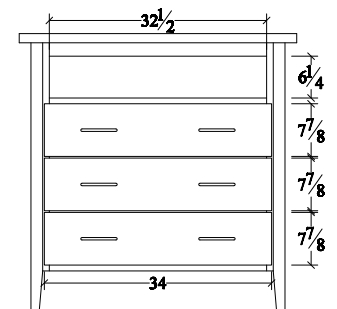

Media Chest (VIMC)
3 drawer, 1 opening
42 1/2 w x 22 1/4 d x 41 1/2 h

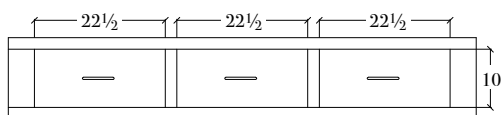

Storage Rail
3 drawer
14h

See pricelist for underbed storage order info.

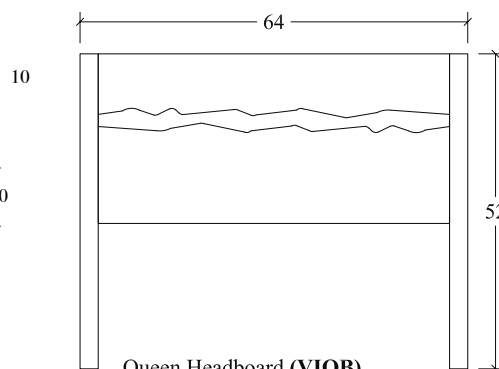

Queen Headboard (VIQB)
64w x 52h

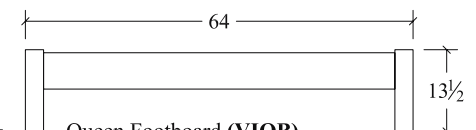

Queen Footboard (VIQB)
64w x 13 1/2h

WILMINGTON *Bedroom Collection*

COLLECTION FEATURES

- Constructed with mortise and tenon joints
- Cast dovetailed brackets support mattress
- Standard with E7 Hardware
- Dovetailed drawers
- Side mount slides
- Case goods are fully framed, solid wood
- Case goods feature 1" solid top
- Armoire features 2 solid hardwood, adjustable shelves
- Chest features a cedar-lined bottom drawer
- All nightstands feature USB A & C Power

COLLECTION OPTIONS

- Distressed finish (#2D)
- Hardware Options - see hardware page in Features & Options section
- Underbed Storage Options
- See upholstery book for fabric and leather choices
- Three plug power strip. Case goods available with touch switch LED night light (#LEDN)
- Night Stand available with sliding top, hidden compartment, lock and three plug power strip (#STP)
- Docking power drawer (#DKD)



Wilmington Bed

Headboard-62" H

Footboard-24 1/4"H

#CWTKB - Cal. King: 78"w x 91"d

#WTKB - King: 83 1/8"w x 87"d

#WTQB - Queen: 67 1/8"w x 87"d

#WTFB - Full: 61"w x 81"d

Wilmington Upholstered Bed

Headboard-56" H

Footboard-27 7/8"H

#CWTUKB - Cal. King: 78"w x 91"d

#WTUKB - King: 82"w x 87"d

#WTUQB - Queen: 66"w x 87"d

#WTUFB - Full: 61"w x 81"d





Wilmington Mirror
#WTMR
41" w x 37" h

Wilmington Dresser
#WTDR66
66" w x 22" d x 37 3/4" h



**Wilmington Chest
6 drawer**
#WTCD
37" w x 22" d x 51" h



Wilmington Nightstand
#WTNS2
26" w x 16" d x 28" h
USB A & C Power



Shown in Rustic White Oak with #120 Chalk color option

WILMINGTON

BEDROOM COLLECTION SPECIFICATIONS

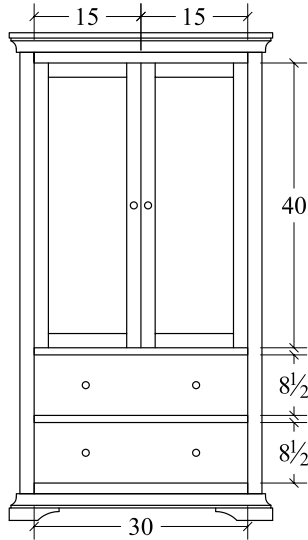

Armoire (WTAR)
2 drawer, 2 door, 2 shelves
37w x 22d x 68 1/2h

*2 shelves and 1 hanger rod

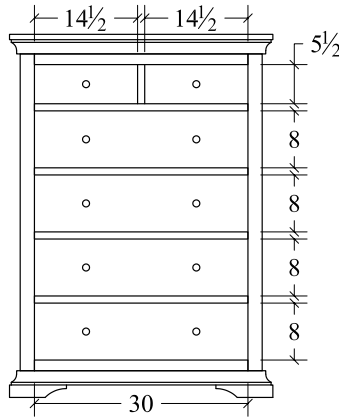

Chest (WTCD)
6 drawer
37w x 22d x 51h

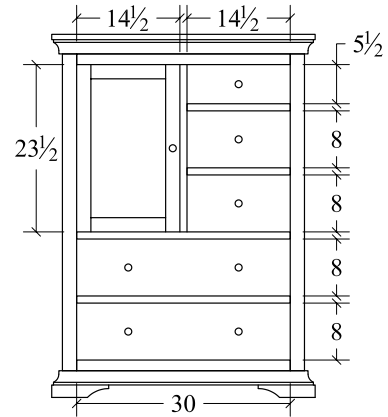

Door Chest (WTDR)
5 drawer, 1 door, 2 shelves
37w x 22d x 51h

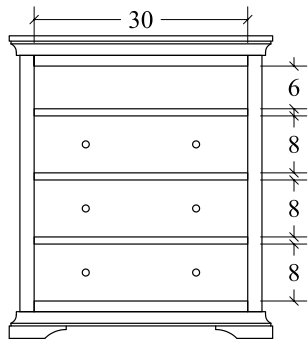

Media Chest (WTMC)
3 drawer, 1 opening
37w x 22d x 42 1/2h

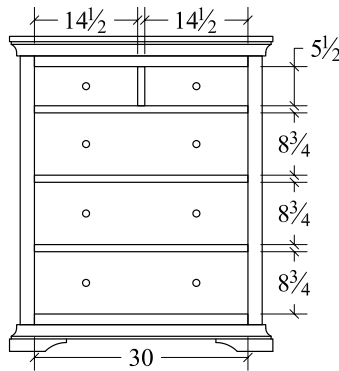

Chest (WTCD5)
5 drawer
37w x 22d x 44 1/4h

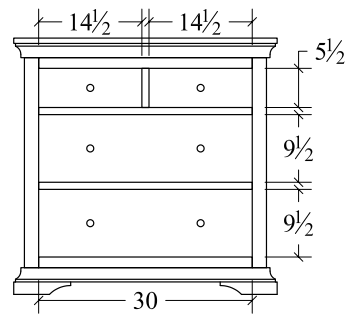

Chest (WTCD4)
4 drawer
37w x 22d x 36h

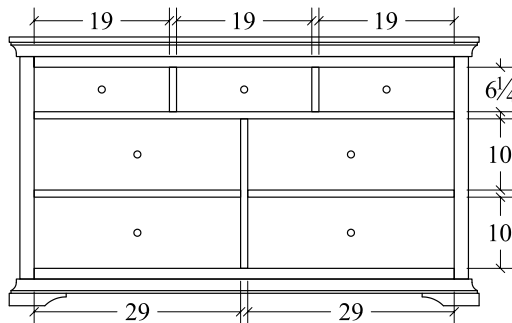

Dresser (WTDR66)
7 drawer
66w x 22d x 37 3/4h

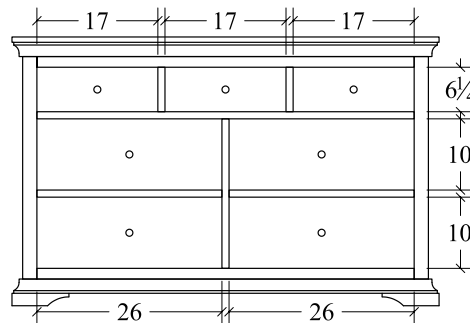

Dresser (WTDR60)
7 drawer
60w x 22d x 37 3/4h

the Wilmington

Drawing Scale: 1/2" = 1'

WILMINGTON

BEDROOM COLLECTION SPECIFICATIONS

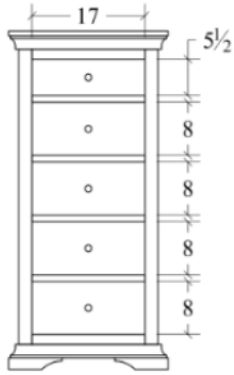

Lingerie Chest (WTLC)
5 drawer
24w x 16d x 51h

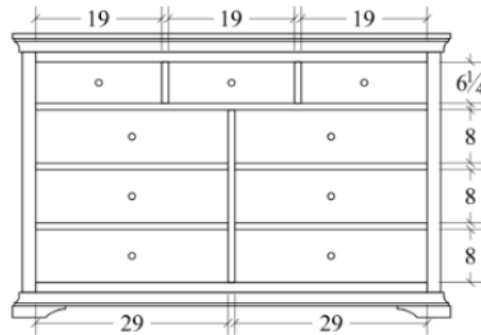

Dresser (WTDR9)
9 drawer
66w x 22d x 42 3/4h

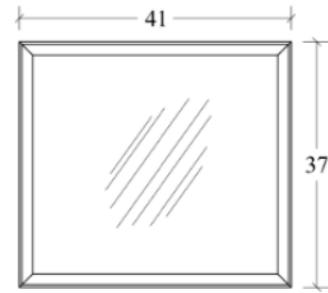

Mirror (WTMR)
41w x 37h

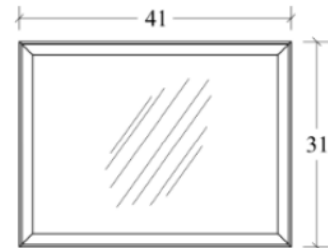

Mirror (WTMR31)
41w x 31h

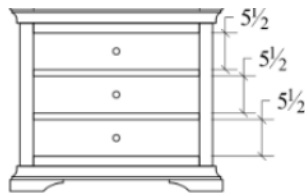

Nightstand (WTNS332)
3 drawer
32w x 16d x 28h

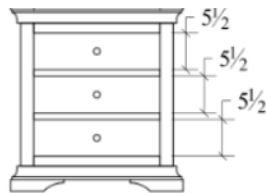

Nightstand (WTNS3)
3 drawer
26w x 16d x 28h

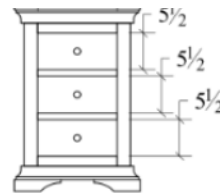

Nightstand (WTNS319)
3 drawer
19w x 16d x 28h

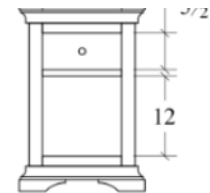

Nightstand (WTNS119)
1 drawer, 1 opening
19w x 16d x 28h

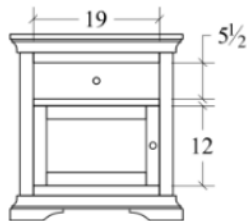

Nightstand (WTNS11L)
1 drawer, 1 door
26w x 16d x 28h

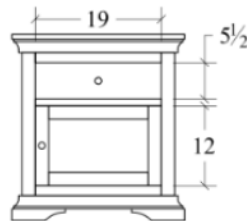

Nightstand (WTNS11R)
1 drawer, 1 door
26w x 16d x 28h



Nightstand (WTNS2)
2 drawer, 1 opening
26w x 16d x 28h

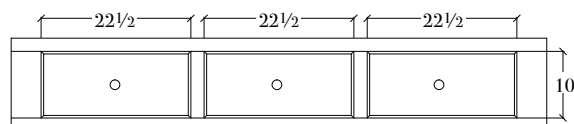

Storage Rail
3 drawer
14h

Cal King (3-2CWTKBRS)
King (3-2WTKBRS)
Queen (3-2WTQBRS)
Full (3-2WTFBRS)
Twin (3-2WTTBRS)

the wilmington

Drawing Scale: 1/2" = 1'





**YOU'LL ADMIRE THE BEAUTY. YOU'LL
APPRECIATE THE VALUE. YOU'LL LOVE THE
LOOK!**

Fusion Designs continues to grow and add to the unique diversity of styles we offer in order to satisfy the most discriminating of shoppers. We're all about the details, start to finish. By selecting only the finest woods and quality hardware, our woodcrafters utilize the best-proven construction techniques to create furniture that is as durable as it is beautiful. Each piece is individually crafted, not mass produced. Our desire is to provide you with the highest quality furniture at the best value. Construction features like these set us apart...compare the integrity, compare the details.