

2026 MATTRESS  
Catalog



HEARTLAND  
MATTRESS



# Our Story

## *Life's greatest blessings sometimes come from its most difficult days.*

When the recession of 2008 caused a downsizing in the RV industry, Mervin Lehman found himself without a job. Shortly after, he had a chance conversation with a neighbor who was part of the Northern Indiana Woodcrafters Association. That's when he learned of a need for quality, handcrafted mattresses.

Sensing an opportunity, Mervin got to work, learning all he could about the mattress industry. He was blessed by the generous support of a seasoned industry professional, who mentored him, spending hours at his kitchen table.

In 2009, Heartland began producing mattresses in a garage. In the years since that simple beginning, Heartland has continued to add mattresses to its product line and

has built a reputation for quality and customer service in both the RV and residential mattress markets.

### **Family-Owned and Operated**

Today, we are still a family business. Mervin handles most of the work with Heartland's retailers. His son-in-law, Jay Bontrager, joined the business in 2016 and now runs the day-to-day operations. They've even gotten help from the next generation—the Signature mattress series is named for the oldest granddaughters, and they've signed their names to the tags.

### **High-Quality Mattresses, Made in the USA**

We use only quality, US-sourced materials in every Heartland mattress. From the foam to the coils, each mattress is handcrafted and inspected prior to shipment. We are dedicated to keeping a standard of excellence in quality and workmanship, with a goal of building a reputation that people will trust for generations.



### **Committed to Service**

Mervin knows that Heartland wouldn't exist without the support he received at the beginning. That's one reason he is committed to supporting our retailers and their customers. We believe that the more we can do for our retailers, the better they can serve the people who visit their stores. While we do not sell directly to consumers, we appreciate everyone who considers or purchases a Heartland mattress. As we say to our retailers, "We'll take care of you so you can take care of your customers."

## TABLE OF CONTENTS

<b>Innerspring Mattresses</b>	4
<i>Solace Series</i>	6
<i>Grand Series</i>	10
<i>Gemstone Series</i>	16
<i>Heirloom Series</i>	20
<b>All-Foam Mattresses</b>	24
<i>Legacy Series</i>	26
<i>Signature Series</i>	30
<b>Mattress Sizes</b>	36
<b>Box Springs</b>	37
<b>Bases &amp; Frames</b>	38
<b>Components &amp; Terms</b>	39
<b>Shipping Options &amp; Point-of-Sale Items</b>	40
<b>Warranty Info</b>	41
<b>Photo Gallery</b>	42



ASU

# Innerspring

## MATTRESSES

Looking for a modern take on a traditional mattress? Our innerspring mattresses use foam paired with an open coil or fabric encased coil base.





Innerspring

# SOLACE SERIES

## Overview:

This new Series is loaded with features. We have fabric encased coils with foam, cooling technology fabric and specialty foams. All working together to deliver a next level of comfort and support.

## Models:

*Lumina*



*Aurora*



*Astra Luxe*



SOLACE SERIES

# Lumina



**Firmness:**









Lumina gives rejuvenating comfort with a cool-to-the touch surface and a generous layer of Serene® foam for pressure-relieving support. Its tight-top design creates a smooth, stable sleep surface, and individually fabric-encased coils provide responsive support and reduced motion transfer. Designed for sleepers who prefer a slightly firmer feel, it balances comfort and durability for long-lasting rest.

**Layers:**

- Quilting
- 2" Serene® Foam
- 10" Fabric Encased Coils with Foam



**Features:**

-  **STYLE**  
1-Sided Tight-top
-  **HEIGHT**  
14"
-  **QUILTING**  
1.5" Foam
-  **COMFORT LAYER**  
2" Serene®
-  **MATTRESS CORE**  
10" Fabric Encased Coils with Foam
-  **BOX SPRING**  
8" Semi-Flex
-  **SHIPPING**  
Standard
-  **WARRANTY**  
15-Year



## SOLACE SERIES

# Aurora

### Features:



**STYLE**  
1-Sided Euro-top



**HEIGHT**  
15"



**QUILTING**  
1.5" Foam



**COMFORT LAYER**  
Latex



**MATTRESS CORE**  
10" Fabric Encased  
Coils with Foam



**BOX SPRING**  
8" Semi-Flex



**SHIPPING**  
Standard



**ADJUSTABLE BED**  
Compatible



**WARRANTY**  
15-Year

### Firmness:



Aurora features a luxurious Euro-top design coupled with 3" of premium latex foam for exceptional responsiveness and breathability. The cool-to-the-touch gold and black knit cover increases comfort while maintaining a refined look. Inside, fabric-encased coils adapt to you, giving consistent support across the mattress. With a plush but supportive feel, Aurora is ideal for sleepers seeking elevated comfort with natural performance benefits.

### Layers:

Quilting  
3" Latex Foam  
10" Fabric Encased  
Coils with Foam

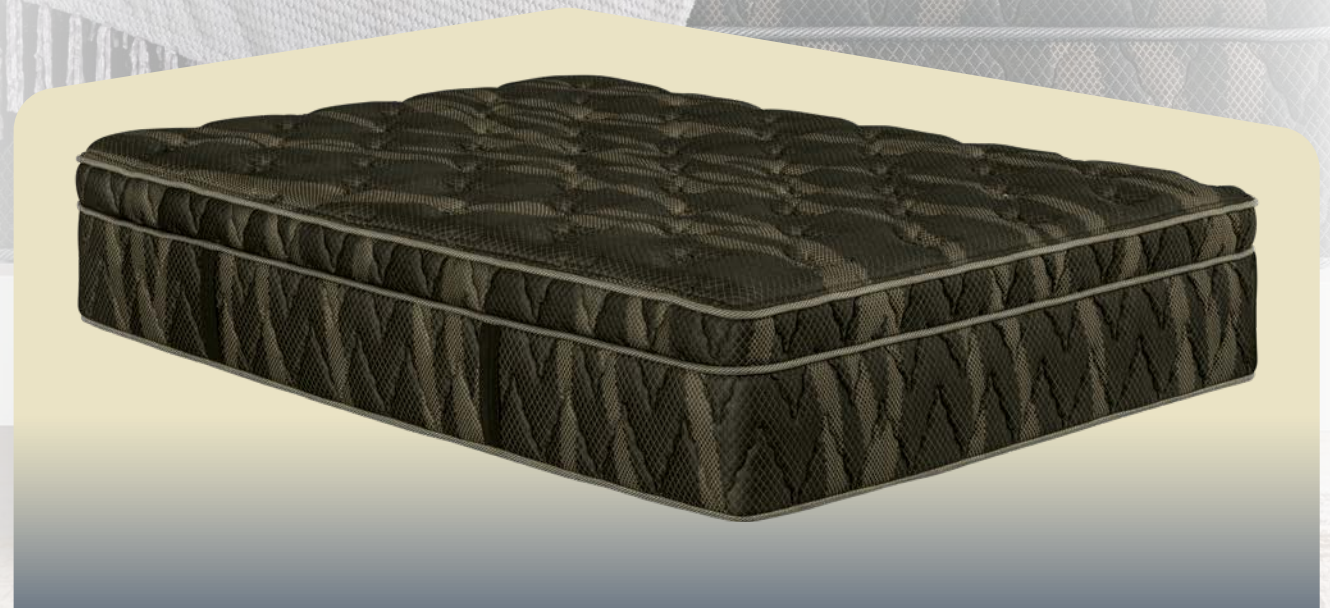

SOLACE SERIES

# Astra Luxe

**Firmness:**



Astra Luxe is the pinnacle of the Solace Series, combining layered Serene® and latex foams for exceptional pressure relief, contouring comfort, and responsive support. Its Euro-top construction gives a plush, refined feel. The 16" profile adds depth and luxury to the mattress. Individually fabric-encased coils provide advanced motion isolation and full-body support. Designed for those who want the most advanced comfort Heartland offers, Astra Luxe delivers a truly elevated sleep experience.

**Layers:**

- Quilting
- 1" Serene® Foam
- 3" Latex Foam
- 10" Fabric Encased Coils with Foam



**Features:**

-  **STYLE**  
1-Sided Euro-top
-  **HEIGHT**  
16"
-  **QUILTING**  
1.5" Foam
-  **COMFORT LAYER**  
Latex & Serene®
-  **MATTRESS CORE**  
10" Fabric Encased Coils with Foam
-  **BOX SPRING**  
8" Semi-Flex
-  **SHIPPING**  
Standard
-  **WARRANTY**  
15-Year



Innerspring

# GRAND SERIES

## Overview:

The Grand Series is 2-sided, built with an 8" fabric encased coil innerspring. These high coil count units have strategic comfort zones to support the hips, back, and shoulders. Specially chosen layers of foam offer additional comfort.

## Models:

Opulence



Splendor



Indulgence



Siesta



10



GRAND SERIES

# Opulence



**Firmness:**











Sleep on the Opulence, made from 8" fabric encased coils topped with a combination of Serene® and Latex.

**Layers:**

- Quilting
- 1" Serene® Foam
- 3" Latex Foam
- 8" Zoned Fabric Encased Coils



**Features:**

-  **STYLE**  
1-Sided Euro-top
-  **HEIGHT**  
13"
-  **QUILTING**  
1" Foam
-  **COMFORT LAYER**  
Latex & Serene®
-  **MATTRESS CORE**  
8" Zoned  
Fabric encased coils
-  **BOX SPRING**  
8" Semi-Flex
-  **SHIPPING**  
Standard
-  **WARRANTY**  
15-Year



## GRAND SERIES

# Splendor

### Features:



#### STYLE

2-Sided Tight Top



#### HEIGHT

14"



#### QUILTING

2" Foam



#### COMFORT LAYER

1" High-Density  
Foam Per Side



#### MATTRESS CORE

8" Zoned Fabric  
Encased Coils



#### BOX SPRING

8" Semi-Flex



#### SHIPPING

Standard



#### ADJUSTABLE BED

Compatible



#### WARRANTY

15-Year

### Firmness:



A softer version of the Siesta, the Splendor comes with 1" of high-density foam and 2" of quilting. Added to both sides, this makes the mattress 14" tall.

### Layers:

Quilting

1" High-Density Foam

8" Zoned Fabric  
Encased Coils

1" High-Density Foam

Quilting



## GRAND SERIES

## Indulgence

**Firmness:**

A pillow top mattress, the Indulgence is 16" of restful sleep. Using the same core as the Siesta and Splendor, we pull out the stops on foam. Both sides of the mattress receive 1" of high-density foam, 1" of visco gel memory foam, and 2" of quilting.

**Layers:**

Quilting  
 Visco Gel Memory Foam  
 1" High-Density Foam  
 8" Zoned Fabric Encased Coils  
 1" High-Density Foam  
 Visco Gel Memory Foam  
 Quilting

**Features:**

-  **STYLE**  
2-Sided Pillow Top
-  **HEIGHT**  
16"
-  **QUILTING**  
2" Foam
-  **COMFORT LAYER**  
1" High-Density Foam & 1" Visco Gel Memory Foam Per Side
-  **MATTRESS CORE**  
8" Zoned Fabric Encased Coils
-  **BOX SPRING**  
8" Semi-Flex
-  **SHIPPING**  
Standard
-  **ADJUSTABLE BED**  
Compatible
-  **WARRANTY**  
15-Year





## GRAND SERIES

# Siesta

### Features:



**STYLE**  
2-Sided Tight Top



**HEIGHT**  
12"



**QUILTING**  
1" Foam



**COMFORT LAYER**  
1" Serene® Foam  
Per Side



**MATTRESS CORE**  
8" Zoned Fabric  
Encased Coils



**BOX SPRING**  
8" Semi-Flex



**SHIPPING**  
Standard



**ADJUSTABLE BED**  
Compatible



**WARRANTY**  
15-Year

### Firmness:



Sleep on the Siesta, made from 8" fabric encased coils topped with a 1" Serene® foam comfort layer and 1" of quilting.

### Layers:

Quilting  
1" Serene® Foam  
8" Zoned Fabric  
Encased Coils  
1" Serene® Foam  
Quilting



# Fabric Encased Coils

Our fabric encased coil units feature individual coils each wrapped in fabric. This allows the coils to flex and conform to the individual contours of the body. This design is unique and can be used on adjustable beds. It can be roll-packed without causing any harmful stress to the unit.



Innerspring

# GEMSTONE SERIES

## Overview:

Quality, comfort, and economy come together in the Gemstone. These mattresses feature 6" fabric encased coils with sturdy edge support. The spring core is topped with layers of high-density foam.

## Models:

*Sapphire*



*Emerald*



*Emerald Pillow Top*



GEMSTONE SERIES

# Sapphire



**Firmness:**





The Sapphire consists of a 6" fabric encased coil core with a 1" foam comfort layer and 1" quilting. This is a single-side mattress.

**Layers:**

- Quilting
- 1" High-Density Foam
- 6" Fabric Encased Coils



**Features:**

-  **STYLE**  
1-Sided Non-Flip
-  **HEIGHT**  
8"
-  **QUILTING**  
1" Foam
-  **COMFORT LAYER**  
1" High-Density Foam
-  **MATTRESS CORE**  
6" Fabric Encased Coils
-  **BOX SPRING**  
8" Semi-Flex
-  **SHIPPING**  
Standard or Roll-Packed
-  **ADJUSTABLE BED**  
Compatible
-  **WARRANTY**  
15-Year

## GEMSTONE SERIES

# Emerald

### Features:



**STYLE**  
2-Sided



**HEIGHT**  
10"



**QUILTING**  
1" Foam



**COMFORT LAYER**  
1" High-Density  
Foam Per Side



**MATTRESS CORE**  
6" Fabric Encased Coils



**BOX SPRING**  
8" Semi-Flex



**SHIPPING**  
Standard or  
Roll-Packed



**ADJUSTABLE BED**  
Compatible



**WARRANTY**  
15-Year

### Firmness:



The Emerald consists of a 6" fabric encased coil base with a 1" foam comfort layer and 1" quilting on both sides.

### Layers:

Quilting  
1" High-Density Foam  
6" Fabric Encased  
Coils  
1" High-Density Foam  
Quilting

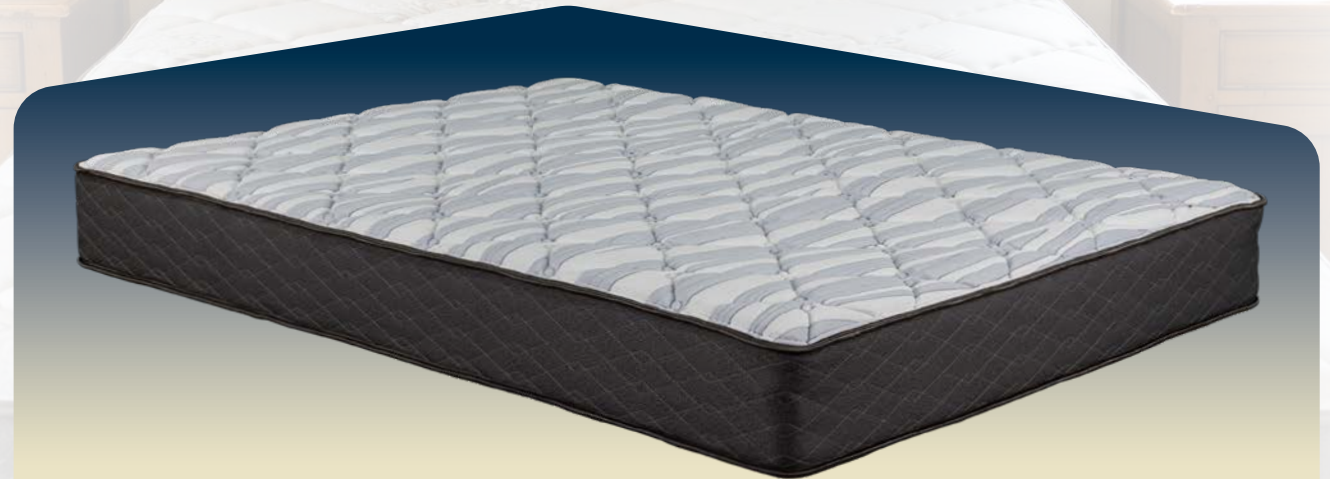



GEMSTONE SERIES

# Emerald Pillow Top



**Firmness:**



The Emerald Pillow Top adds a layer of Serene® foam to the comfortable design of the Emerald.

**Layers:**

- Quilting
- Serene® Foam
- 1" High-Density Foam
- 6" Fabric Encased Coils
- 1" High-Density Foam
- Serene® Foam
- Quilting



**Features:**

- STYLE**  
2-Sided
- HEIGHT**  
12"
- QUILTING**  
1" Foam
- COMFORT LAYER**  
1" High-Density Foam Per Side
- MATTRESS CORE**  
6" Fabric Encased Coils
- BOX SPRING**  
8" Semi-Flex
- SHIPPING**  
Standard or Roll-Packed
- ADJUSTABLE BED**  
Compatible
- WARRANTY**  
15-Year



Innerspring

# HEIRLOOM SERIES

## Overview:

A traditional innerspring mattress with modern enhancements. The 2-sided design uses a spring core placed between layers of comfort foam. The core is engineered for edge-to-edge active support, gently flexing as you move while minimizing motion transfer.

## Models:

*Heirloom Classic*



*Heirloom Firm*



*Heirloom Pillow Top*



HEIRLOOM SERIES

# Heirloom Classic



**Firmness:**



Sleep well on a mattress with a comfortable Lura-Flex® core that is topped with a 2" high-density foam comfort layer and 1½" foam quilting.

**Layers:**

- Quilting
- 2" High-Density Convoluted Foam
- Lura-Flex® 660 Innerspring
- 2" High-Density Foam
- Quilting

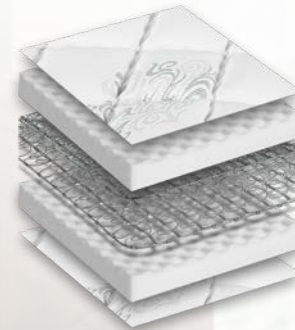

**Features:**

-  **STYLE**  
2-Sided Tight Top
-  **HEIGHT**  
13"
-  **QUILTING**  
1½" Foam
-  **COMFORT LAYER**  
2" High Density Convoluted Foam Per Side
-  **MATTRESS CORE**  
Lura-Flex®
-  **BOX SPRING**  
8" Semi-Flex
-  **SHIPPING**  
Standard
-  **WARRANTY**  
15-Year



## HEIRLOOM SERIES

# Heirloom Firm

### Features:



#### STYLE

2-Sided Tight Top



#### HEIGHT

13"



#### QUILTING

1½" Foam



#### COMFORT LAYER

2" High Density Firm Foam Per Side



#### MATTRESS CORE

Lura-Flex®



#### BOX SPRING

8" Semi-Flex



#### SHIPPING

Standard



#### WARRANTY

15-Year

### Firmness:



The Heirloom Firm features the same quality formula as the Classic, but with firmer layers of foam.

### Layers:

Quilting

2" High-Density Firm Foam

Lura-Flex® 660

Innerspring

2" High-Density Firm Foam

Quilting



HEIRLOOM SERIES

# Heirloom Pillow Top



**Firmness:**



Enjoy the benefits of a well-engineered spring foundation with several layers of comforting foam. The Pillow Top consists of a Lura-Flex® innerspring with 4½" of layered foam on both sides (2" convoluted foam, 1" foam pillow top, 1½" quilting).

**Layers:**

- Quilting
- 1" High-Density Foam in Pillow Top
- 2" High-Density Convoluted Foam
- Lura-Flex® 660 Innerspring
- 2" High-Density Convoluted Foam
- 1" High-Density Convoluted Foam
- Quilting



**Features:**

-  **STYLE**  
2-Sided Tight Top
-  **HEIGHT**  
15"
-  **QUILTING**  
1½" Foam
-  **COMFORT LAYER**  
1" High-Density Foam & 2" High-Density Convoluted Foam Per Side
-  **MATTRESS CORE**  
Lura-Flex®
-  **BOX SPRING**  
8" Semi-Flex
-  **SHIPPING**  
Standard
-  **WARRANTY**  
15-Year



# All-Foam

## MATTRESSES

Discover our all-foam mattress options. We laminate selected high-density foams to produce mattresses fit for a good night's sleep.



All-Foam

# LEGACY SERIES

## Overview:

For this single-sided mattress, we start with a firm foam base and add 3 inches of medium-comfort foam (latex, memory, or Serene®). We finish the mattress with traditional quilting and edge-beading.

## Models:

*Sweet Serenity*



*Sweet Dreams*



*Sweet Sensations*



LEGACY SERIES

# Sweet Serenity

**Firmness:**



Take layers of high density foam and top them with 3" of Serene® foam and 1" of quilting. The Sweet Serenity is one of our softest.

**Layers:**

- Quilting
- 3" Serene® Foam
- Layered High-Density Foam

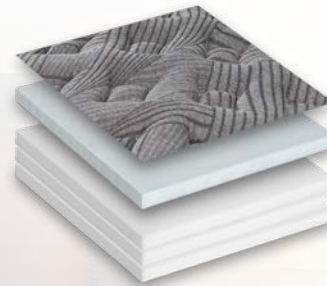

**Features:**

-  **STYLE**  
All-Foam, Non-Flip
-  **HEIGHT**  
12"
-  **QUILTING**  
1" Foam
-  **COMFORT LAYER**  
3" Serene® Foam
-  **MATTRESS CORE**  
Layered High-Density Foam
-  **BOX SPRING**  
8" Semi-Flex
-  **SHIPPING**  
Standard or Roll-Packed
-  **ADJUSTABLE BED**  
Compatible
-  **WARRANTY**  
15-Year



## LEGACY SERIES

# Sweet Dreams

### Features:



#### STYLE

All-Foam, Non-Flip



#### HEIGHT

12"



#### QUILTING

1" Foam



#### COMFORT LAYER

3" Latex



#### MATTRESS CORE

Layered High-Density Foam



#### BOX SPRING

8" Semi-Flex



#### SHIPPING

Standard or Roll-Packed



#### ADJUSTABLE BED

Compatible



#### WARRANTY

15-Year

### Firmness:



The Sweet Dreams uses the same foundational foam and 1" of quilting as the others in this series but includes 3" of latex, giving a unique "on top of the foam" sleep.

### Layers:

Quilting

3" Latex

Layered High-Density Foam



LEGACY SERIES

# Sweet Sensations



**Firmness:**



Instead of Serene® or latex, Sweet Sensations uses 3" of visco gel memory foam as its comfort layer. For those preferring an "in the foam" sleeping experience.

**Layers:**

- Quilting
- 3" Visco Gel Memory Foam
- Layered High-Density Foam



**Features:**

-  **STYLE**  
All-Foam, Non-Flip
-  **HEIGHT**  
11"
-  **QUILTING**  
1" Visco
-  **COMFORT LAYER**  
3" Visco Gel Memory Foam
-  **MATTRESS CORE**  
Layered High-Density Foam
-  **BOX SPRING**  
8" Semi-Flex
-  **SHIPPING**  
Standard or Roll-Packed
-  **ADJUSTABLE BED**  
Compatible
-  **WARRANTY**  
15-Year



All-Foam

# SIGNATURE SERIES

## Overview:

A single-sided mattress that starts with a firm foam base. To this, we add 3 inches of medium-comfort foam (latex, memory, or Serene®). We finish the mattresses with rounded edges and a zippered cover. Named for three granddaughters, the tags carry their signatures.

## Models:

*Amy Marie*



*Leann Rose*



*Heidi Ann*



*Emily Grace*



30



SIGNATURE SERIES

# Amy Marie



**Firmness:**









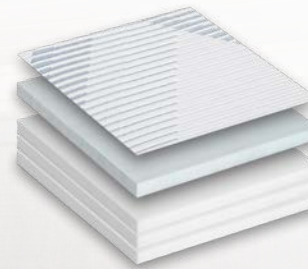

Take layers of high density foam and top them with 3" of Serene® foam and a zippered cover. Amy Marie is one of our softest.

**Layers:**

- Zippered Cover
- 3" Serene® Foam
- Layered High-Density Foam



**Features:**

-  **STYLE**  
All-Foam, Non-Flip
-  **HEIGHT**  
10"
-  **QUILTING**  
Zippered Cover
-  **COMFORT LAYER**  
3" Serene® Foam
-  **MATTRESS CORE**  
Layered High-Density Foam
-  **BOX SPRING**  
8" Semi-Flex
-  **SHIPPING**  
Standard or Roll-Packed
-  **ADJUSTABLE BED**  
Compatible
-  **WARRANTY**  
15-Year



## SIGNATURE SERIES

# Leann Rose

### Features:

 **STYLE**  
All-Foam, Non-Flip

 **HEIGHT**  
10"

 **QUILTING**  
Zippered Cover

 **COMFORT LAYER**  
3" Latex

 **MATTRESS CORE**  
Layered High-Density Foam

 **BOX SPRING**  
8" Semi-Flex

 **SHIPPING**  
Standard or Roll-Packed

 **ADJUSTABLE BED**  
Compatible

 **WARRANTY**  
15-Year

### Firmness:



The Leann Rose uses the same foundational foam and zippered cover as the others in this series but includes 3" of latex, giving a unique "on top of the foam" sleep.

### Layers:

Zippered Cover

Latex

Layered High-Density Foam



SIGNATURE SERIES

# Heidi Ann



**Firmness:**



Instead of Serene® or latex, Heidi Ann uses 3" of visco gel memory foam as its comfort layer. Like other Signature mattresses, it uses a layered foam base and has a zippered cover. It is ideal for those preferring an “in the foam” sleeping experience.

**Layers:**

- Zippered Cover
- 3" Visco Gel Memory Foam
- Layered High-Density Foam

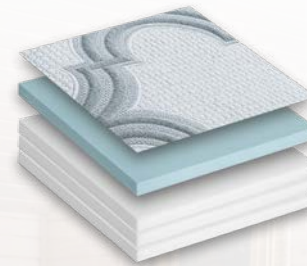

**Features:**

-  **STYLE**  
All-Foam, Non-Flip
-  **HEIGHT**  
10"
-  **QUILTING**  
Zippered Cover
-  **COMFORT LAYER**  
3" Visco Gel Memory Foam
-  **MATTRESS CORE**  
Layered High-Density Foam
-  **BOX SPRING**  
8" Semi-Flex
-  **SHIPPING**  
Standard or Roll-Packed
-  **ADJUSTABLE BED**  
Compatible
-  **WARRANTY**  
15-Year

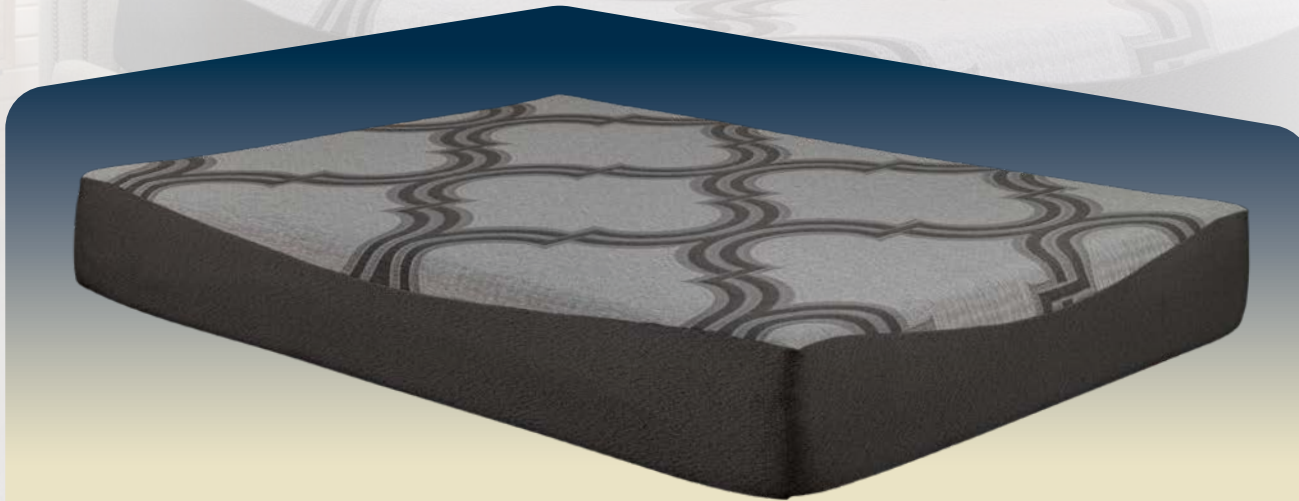

## SIGNATURE SERIES

# Emily Grace

### Features:

 **STYLE**  
All-Foam, Non-Flip

 **HEIGHT**  
10"

 **QUILTING**  
Zippered Cover

 **COMFORT LAYER**  
Hybrid TheraGel® & Tranquility® Foam

 **MATTRESS CORE**  
High-Density Foam

 **BOX SPRING**  
8" Semi-Flex

 **SHIPPING**  
Standard or Roll-Packed

 **ADJUSTABLE BED**  
Compatible

 **WARRANTY**  
15-Year

### Firmness:



Combining the characters of Tranquility® foam and Hybrid TheraGel® foam, we get a very soft but supportive response for those who appreciate the Memory foam feel, yet breathable and not as temperature sensitive.

### Layers:

Zippered Cover  
2" Tranquility® Foam  
3" Hybrid TheraGel® Foam  
High Density Foam

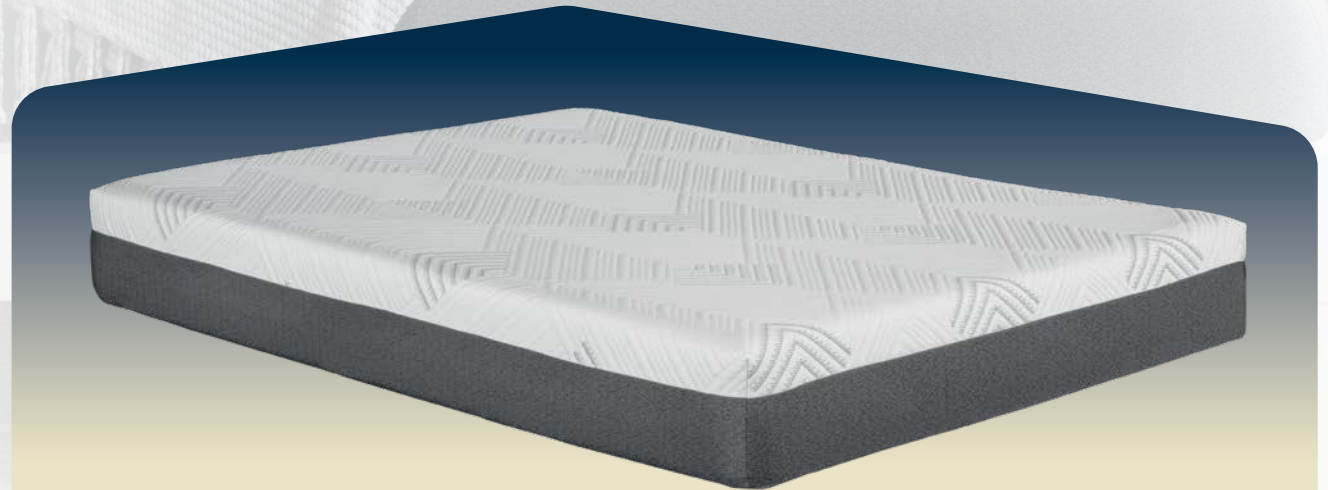
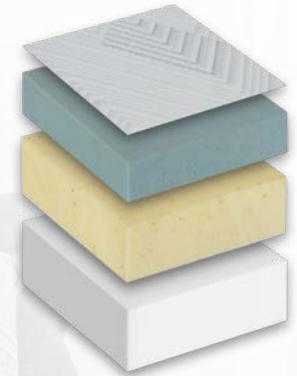

**Featuring:**

Tranquility® Active  
Response Foam and Hybrid  
TheraGel® Antimicrobial  
Memory Foam

Tranquility® foam is the most  
breathable active response foam on  
the market, providing 2x more airflow  
compared to other products.

Tranquility® foam offers excellent  
support and unprecedented durability.

Hybrid TheraGel® combines the  
properties of several products:

Serene® + Isotonic™ + TheraGel™ =  
Hybrid TheraGel™

COPPER • GRAPHITE • SILVER



# Mattress Sizes

Our mattresses are available in a wide variety of sizes:

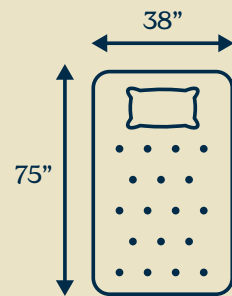

Twin

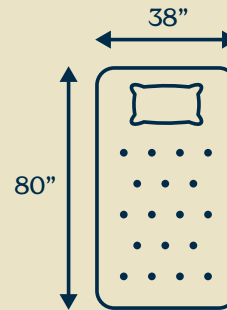

Twin XL

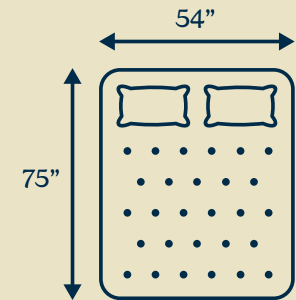

Full

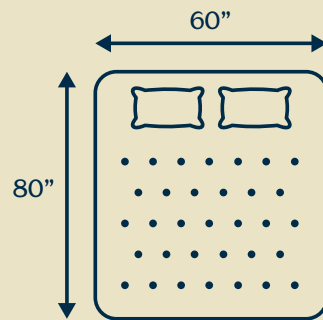

Queen

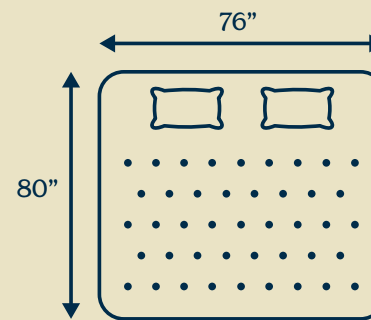

King

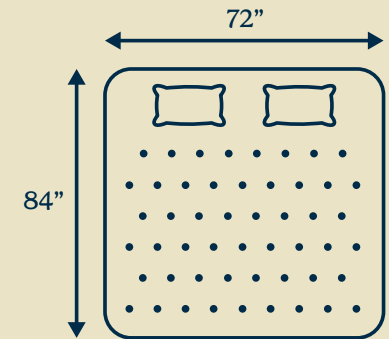

California King  
(N/A in Innerspring unit)

We can manufacture custom sizes on some of our mattresses. Please keep in mind that due to federal regulations 1632 & 1633 and several other state and city laws, we cannot change the make-up of a mattress without testing a new prototype unless a one-time medical exemption is provided by a doctor.

# Box Springs

## *A box spring plays a big part in the life of a mattress.*

Here at Heartland, we are dedicated to only using top-quality box springs. Semi-Flex box springs are designed to properly support your mattress for many years.

### **SEMI-FLEX**

The unique grid/leg assembly is very efficient, firmer, durable, and noiseless. The reinforced grid adds surface coverage and enhanced stability. The performance grid is 14% stronger than the original 3-gauge border. A complete one-piece steel foundation with no separate components. The box spring passes all durability tests including Cornell, Rollator, and Impact.

### **STANDARD PROFILE**

The grid height is 6". The total height of the box spring is 8".

### **LOW PROFILE**

The spring height is 3". The total height of the box spring is 5".

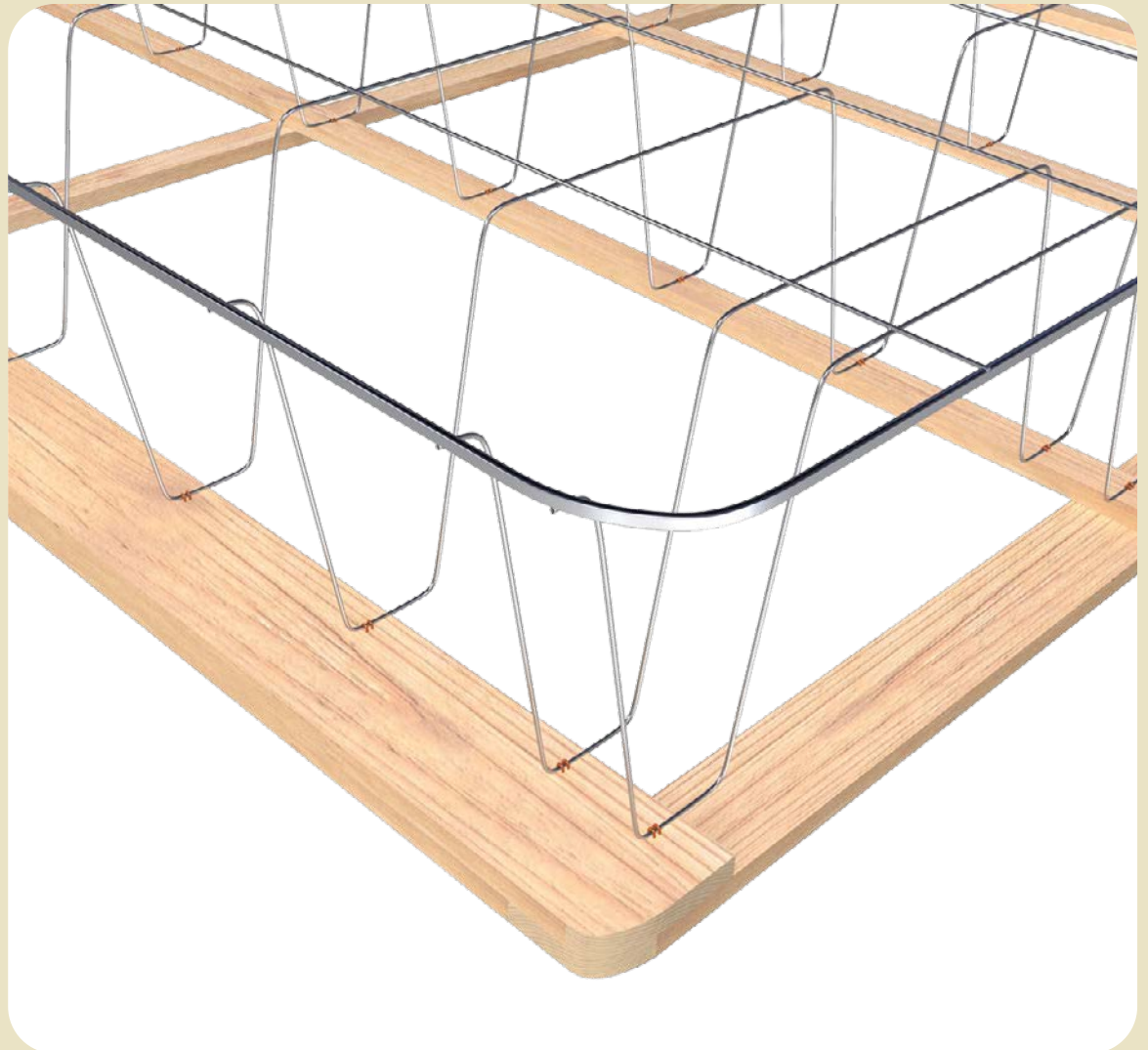

# Bases & Frames

## Heartland's Adjustable Bed Base

Engineered for comfort and convenience, the Heartland Adjustable 2.0 is an adjustable base with a zero clearance design that makes it compatible with most platform and slat beds. It includes our newest remote design – placing access to key features such as massage with wave, under-bed light, and head and foot articulation in the palm of your hand. You can also operate the base through the mobile app for even greater convenience. Enjoy a relaxing bedroom environment and wake up feeling refreshed with the Heartland Adjustable 2.0 bed base.

The adjustable base is compatible with all of our mattresses except the Heirloom Series.



## KEY FEATURES

*Head and Foot Articulation* – Effortlessly raise the head or foot to find your perfect relaxation position.

*Parcel Carrier Friendly* – Parcel carrier friendly sizes are available to simplify delivery to retail stores and consumer homes.

*Wireless Remote* – This base includes a wireless, Bluetooth, 17 button remote. The remote offers many features, including programmable positions and a snore button.

*One-Touch Flat Button* – Easily return the bed to a flat position with the touch of a button.

*Flashlight* – Find your way in the dark with a convenient flashlight on the remote control.

*Height-Adjustable Legs* – Heavy-duty 2.5" diameter legs easily adjust from 8" to 13" for a free-standing setup and perfect fit inside case goods.

## Standard Bed Frames

See our price list for warranty-compliant bed frames.

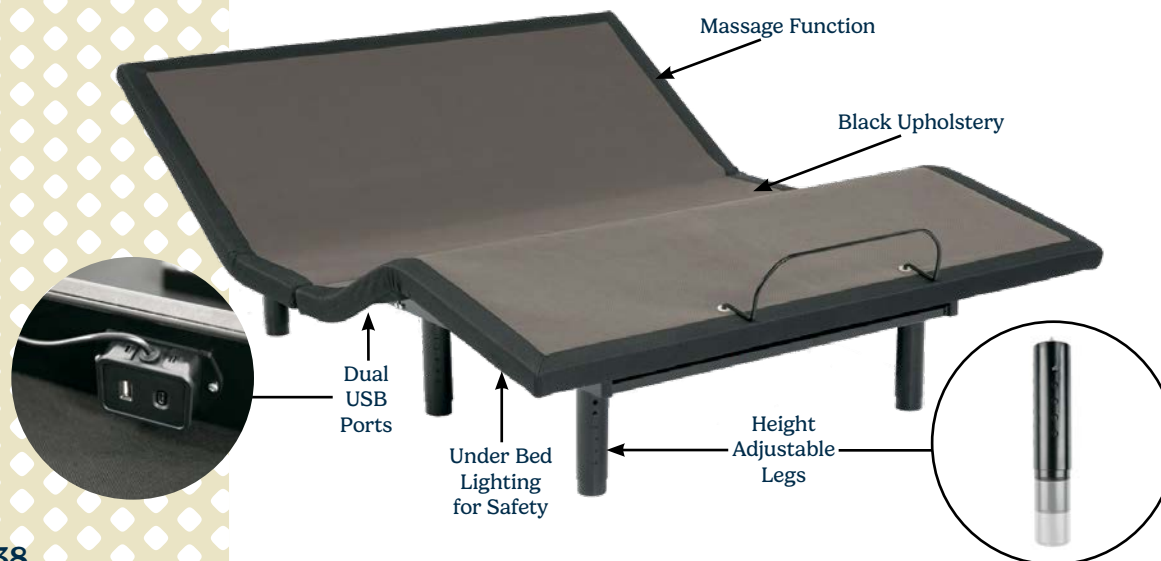

# Components & Terms

**PREMIUM FOAMS** In all our premium mattresses, we use a high-density foam to maintain long-lasting comfort.

**QUALITY BOX SPRINGS** Featuring heavy-duty Semi-Flex springs.

**CENTER SUPPORT** Featuring Ring Flex in our mattress centers. While all mattresses will eventually show some body impression, this feature helps alleviate this problem.

**FULL EDGE SUPPORT** We use Edge Guard technology for full edge support to eliminate broken edges and border wire.

**VISCO GEL MEMORY FOAM** Visco is a memory foam developed by NASA. Visco is sensitive to body heat. The warmer it becomes, the softer it will be. Visco tends to sleep warmer. Heartland uses a brand using cool technology that sleeps 2° cooler than other memory foams. All our visco beds feature a 4 lb. or better quality.

**LATEX FOAM** Latex foam is a natural foam using sap from a rubber tree which is boiled down and poured into a form with pins that form air holes, allowing it to breathe. Latex is a premium foam with a projected lifetime of 20-25 years. It is also a natural dust mite deterrent, so you will have less dust in your mattresses, hence better quality of air at night and less proneness to allergies. Because all-natural latex is extremely heavy and expensive, we used a blended version.

**SERENE®** A specialty foam that self-adjusts to individual body contours. Serene® is the registered trademark of Carpenter Co.

**FABRIC ENCASED COILS** Our fabric encased coil units feature individual coils each wrapped in fabric. This allows the coils to flex and conform to the individual contours of the body. This design is unique and can be used on adjustable beds. It can be

roll-packed without causing any harmful stress to the unit.

**SEMI-FLEX** The unique grid/leg assembly is very efficient, firmer, durable, and noiseless. A reinforced grid adds surface coverage and enhanced stability. The performance grid is 14% stronger than the original 3-gauge border. A complete one-piece steel foundation with no separate components. This box spring passes all durability tests, including Cornell, Rollator, and Impact.

**CALIBER EDGE** Fabric encased coils with different diameter gauges that allow strength and stability around the perimeter of the mattress.

**INNERSPRINGS** All our innerspring mattresses are manufactured using recycled domestic steel. We do not use any imports. Most of our premium-line have 13-gauge (heavy-duty) innersprings. Our 660 coil (full-size) features inverted

innersprings and the helical coil is run lengthwise. This also helps reduce motion transfer.

**FOUNDATIONS** Heartland is committed to a quality box spring. Most sagging mattresses come from lesser-quality bed frames or from not having center support, resulting in box spring failure. Sales reps must stress the need for a center support. We require all bed frames to have a minimum of one center support leg to the floor (a king-size needs four).

**QUALITY WORKMANSHIP** While we do not claim to build a perfect mattress, we strive to come as close as humanly possible. Each individual mattress is handcrafted and inspected prior to shipment. Heartland Mattress LLC is dedicated to maintaining a standard of excellence in quality and workmanship with a goal to build a brand name (Heartland) that you can trust for generations.

# Shipping Options

## *For your convenience and competitive advantage*

we can roll-pack and ship to you or your customer. We can wrap mattresses in plastic or place them in boxes. Please indicate your preference when placing your order.



## *Point-of-Sale Items*

We offer the following items to enhance your display and boost your sales:

- **Foot Protectors** - Embroidered with Logo
- **Pillows** - Embroidered with Logo
- **Mini (Sample) Mattresses**





# Warranty Info

## THE HEARTLAND PROMISE

The quality and craftsmanship that are built into every Heartland mattress and foundation allow Heartland to offer a limited warranty against defects in workmanship or materials. This warranty extends only to the original purchaser.

Proof of purchase with date, place of purchase, and purchase price is required to obtain service under this warranty.

If service resulting from any such defect is required during the non pro-rated year(s) after purchase, your Heartland mattress and/or foundation will be repaired, or - at the manufacturer's option - replaced without charge for labor and material, exclusive of transportation costs.

If service resulting from such defect is required during the remaining years of the applicable limited warranty, your Heartland mattress or foundation will be repaired, or - at the manufacturer's option - replaced at the charge for labor and materials calculated according to the warranty code of the model you purchased, plus all transportation costs. If identical materials are not available at time of service, manufacturer may substitute materials of comparable quality.

## RETAIN YOUR PROOF OF PURCHASE:

This Limited Warranty shall NOT apply under the following circumstances:

1. If bedding is found to be unsanitary.
2. When product failure is due to a cause other than defective workmanship or material.
3. Any larger-size mattress and/or foundation that is used on a frame or bed rails without center support legs.
4. Any damage to the outer fabric of the cover, including wear and tear.
5. If this product is used for commercial purposes.
6. If purchaser does not present proof of purchase.
7. If the mattress is not used on a matching Heartland (or equivalent quality) box spring/foundation with a proper frame that has a rigid center support.

## CONSUMER ADVISORY:

All mattresses will show body impressions as the upholstery settles. This is not a structural defect covered by this warranty. The upholstery is intended to provide cushioning and body comfort. This body impression is unavoidable and is not an indication of any structural failure of your new mattress.

All implied warranties on this product, including any implied warranty of merchantability or fitness for a particular purpose, shall not exceed in duration the term of this limited warranty.

The remedies provided herein are the exclusive remedies provided under any warranty for this product, express or implied. The manufacturer shall not be liable for incidental or consequential damage arising out of the use of this product, and in no event shall its liability exceed the purchase price of the product.

To obtain performance under this Limited Warranty: (1) Contact the retailer from whom you purchased your Heartland product; (2) If your retailer is unavailable, telephone or contact the manufacturer.



# Photo Gallery





SIGNATURE SERIES | *Amy Marie*



SOLACE SERIES | *Astra Luxe*



GRAND SERIES | *Opulence*



HEIRLOOM SERIES | *Heirloom Pillow Top*



HEARTLAND  
MATTRESS

Phone: 260.768.7875 | Fax: 260.768.7099  
1770 N. 500 W., Shipshewana, IN 46565  
[heartlandmattress.net](http://heartlandmattress.net)